

→ WL 70 IDO-10035
HEALTH & SAFETY
TID-4500 (15TH ED)

1959

NUCLEAR INCIDENT AT THE IDAHO CHEMICAL PROCESSING PLANT

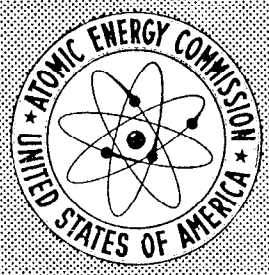
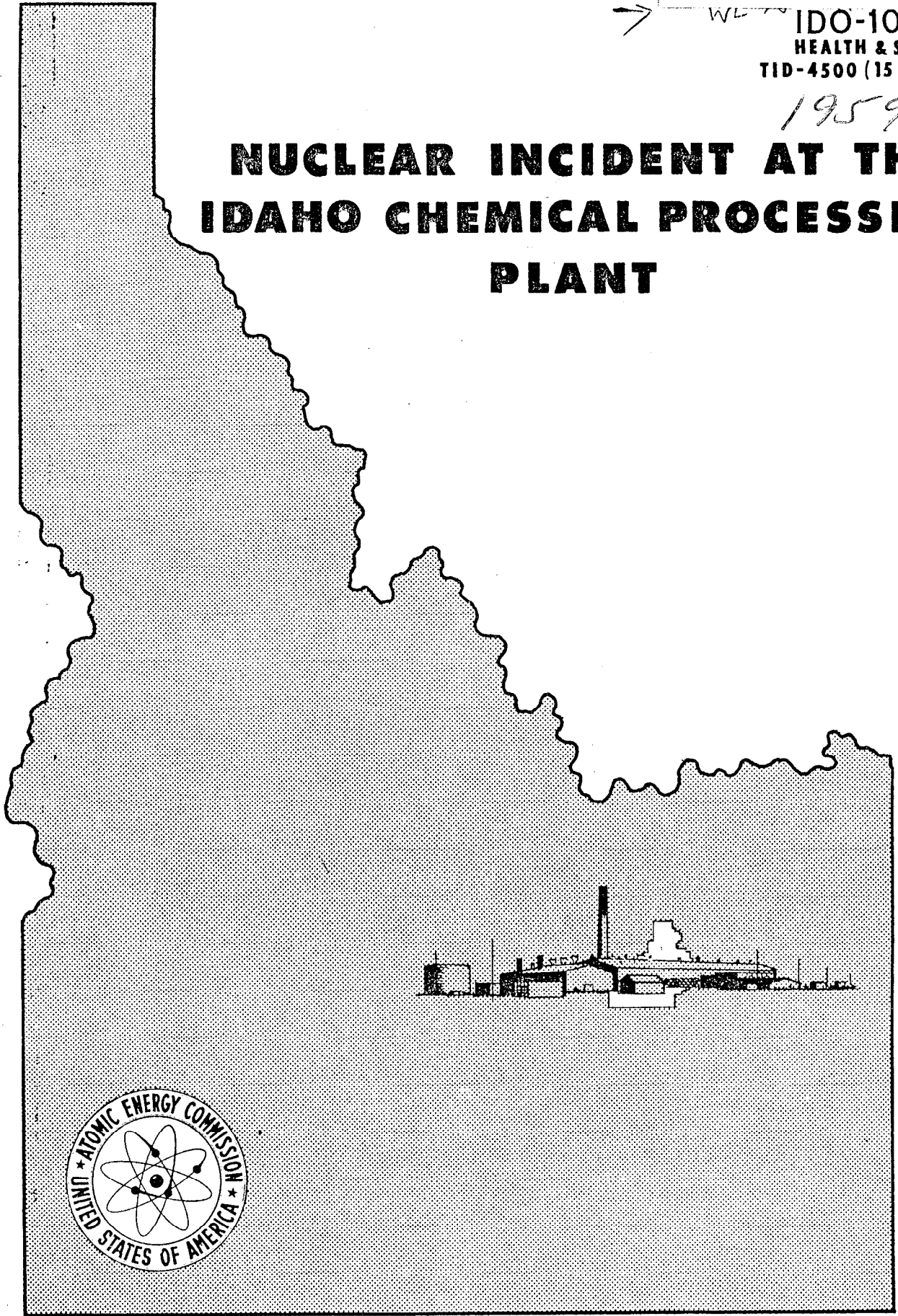

NATIONAL REACTOR TESTING STATION

PRICE \$2.25

Available from the
Office of Technical Services
U. S. Department of Commerce
Washington 25, D. C.

LEGAL NOTICE

This report was prepared as an account of Government sponsored work. Neither the United States, nor the Commission, nor any person acting on behalf of the Commission:

A. Makes any warranty or representation, express or implied, with respect to the accuracy, completeness, or usefulness of the information contained in this report, or that the use of any information, apparatus, method, or process disclosed in this report may not infringe privately owned rights; or

B. Assumes any liabilities with respect to the use of, or for damages resulting from the use of any information, apparatus, method, or process disclosed in this report.

As used in the above, "person acting on behalf of the Commission" includes any employee or contractor of the Commission, or employee of such contractor, to the extent that such employee or contractor of the Commission, or employee of such contractor prepares, disseminates, or provides access to, any information pursuant to his employment or contract with the Commission, or his employment with such contractor.

NUCLEAR INCIDENT
at the
IDAHO CHEMICAL PROCESSING PLANT
on
OCTOBER 16, 1959

REPORT OF THE INVESTIGATING COMMITTEE

by

William L. Ginkel, Chairman
C. Wayne Bills
Aubrey O. Dodd
Klem K. Kennedy
Fred H. Tingey

PHILLIPS PETROLEUM COMPANY - ATOMIC ENERGY DIVISION
U. S. ATOMIC ENERGY COMMISSION - IDAHO OPERATIONS OFFICE
Idaho Falls, Idaho February 15, 1960

ABSTRACT

A nuclear incident involving uranium process solutions occurred at the Idaho Chemical Processing Plant, National Reactor Testing Station on October 16, 1959. This report by the Investigating Committee, appointed by the Manager, Idaho Operations Office, USAEC, discusses the events leading to the incident, describes the consequences of the nuclear excursion, including radioactive contamination and personnel exposures, and submits the findings and recommendations of the committee. Additional detail and data on operational background, health physics and material balance aspects of the incident and supporting drawings, graphs and charts are contained in Sections II and III of the report.

CONTENTS

	Page
Abstract	iii
Section I - Report of the Investigation	1
A - Summary	1
B - Findings	1
C - Conclusions	5
D - Recommendations	6
E - Acknowledgment	8
F - Signature of the Committee	9
Section II - Supplemental Information	11
A - Operational Aspects and Background	11
B - B Cell Hydraulic Characteristics	21
C - Nuclear Aspects	23
D - Health Physics Aspects	29
E - Material Balances	32
F - Action on Recommendations	34
Section III - Appendix - Tables, Figures and Exhibits	37
Table I - External Exposures to Personnel in rem from Film Badge Dosimetry	37
Table II - Calculated Internal Exposure to Personnel	38
Table III - Activity in Blood and Urine	39
Table IV - Wind and Temperature Data for Central Facilities October 16, 1959	40
Table V - Vessel Volume and Uranium Content	41
Table VI - Intermediate Material Balances on PEW Tanks	42
Table VII - Final Material Balance	43
Figure 1 - Process Building Arrangement	45
Figure 2 - Cell B	46
Figure 3 - Waste Collection System	47
Figure 4 - Relative Cell Locations	48
Figure 5 - Cross Section Building 601	49
Figure 6 - Plan View Operation Area CPP-601	50
Figure 7 - First Floor Plan Laboratory Building 602	51
Figure 8 - Second Floor Plan Laboratory Building 602	52
Figure 9 - PEW Instrument Chart	53
Figure 9A - Enlargement of Portion of PEW Instrument Chart	55
Figure 10 - B-100 Instrument Chart	57
Figure 11 - B-110 Instrument Chart	59
Figure 12 - B Cell Control Area	61
Figure 13 - PEW Division Box	62
Figure 14 - CPP Area Plot Plan	63
Figure 15 - NRTS Plan Cloud Trajectories	64
Figure 16 - Schematic Diagram of A-B Cell Equipment	65
Figure 17 - Comparison of Calculated and Measured Pressure Drop for B-100 VOG Line	66
Figure 18 - Comparison of Calculated and Measured Pressure Drop for B-110 VOG Line	67

CONTENTS

	Page
Figure 19 - Effect of Liquid on Pressure Drop for Bank B-100 VOG Line	68
Figure 20 - Effect of Liquid on Pressure Drop for Bank B-110 VOG Line	69
Figure 21 - Effect of Liquid in VOG System on Back Pressure in B-110 Bank	70
Figure 22 - Effect of Sparge Rate on Expansion Ratio	71
Figure 23 - Schematic Diagram of B-100 Bank and PEW Jet Transfer Line	72
Figure 24 - Plot of k_{eff} at Successive Stationary States	73
Figure 25 - Plot k_{eff} vs. Time for Three Degrees of Mixing	74
Figure 26 - CAM Chart Building 601 WG-WH Control Area	75
Figure 27 - CAM Chart Building 601 Access Corridor at L Cell	76
Figure 28 - CAM Chart Building 601 PM Area at L Cell	77
Figure 29 - CAM Chart Building 602 ICPP Cafeteria	78
Figure 30 - CAM Chart Building 630 Welding Shop	79
Figure 31 - CAM Chart Building 603 East End FECF	80
Figure 32 - CAM Chart Building 603 West End FECF	81
Figure 33 - CAM Chart Building CF 646 Top-Side Location	82
Exhibit A - Phillips Inter-office Memorandum, W. H. Burgus to F. P. Vance, Subject - Radiochemical Analyses of CPP Materials, dated October 28, 1959	83
Exhibit B - Letter, L. L. Leedy to J. Bion Philipson, Subject - Costs on ICPP Incident, dated February 18, 1960	91
Exhibit C - Phillips Inter-office Memorandum, R. L. Doan to J. P. Lyon, Subject - ICPP Safeguard Committee, dated November 2, 1959	92
Exhibit D - Phillips Inter-office Memorandum, W. B. Lewis to J. R. Huffman, Subject - Analysis of Critical Incident at ICPP, dated February 19, 1960	94

NUCLEAR INCIDENT AT THE IDAHO CHEMICAL PROCESSING PLANT

SECTION I - REPORT OF INVESTIGATION

A. SUMMARY

At approximately 0250 Friday, October 16, 1959 a nuclear incident occurred in a process equipment waste collection tank at the Idaho Chemical Processing Plant, National Reactor Testing Station. Radiation alarms in the plant were set off by the resulting release of air-borne radioactivity, and 21 shift workers and security personnel on duty evacuated the process building and the surrounding area of high radioactivity.

Available evidence indicates the critical condition resulted from the accidental transfer of a concentrated uranyl nitrate solution from geometrically safe storage banks in a process cell into a waste collection tank through a line normally used to transfer decontaminating solutions to waste. Siphon action initiated by air sparging was the most likely mechanism by which the transfer took place.

Of the 21 personnel directly involved in this incident only seven received significant external exposure to radiation. Of the seven none received a year's maximum permissible exposure of 15 rem penetrating radiation (highest received was 8 rem). Only two exceeded the year's maximum permissible exposure of 30 rem to the skin (individual external exposures of 50 rem and 32 rem). No medical treatment was required. Additional checks have disclosed no neutron exposure nor significant internal dose from inhalation. The waste collection tanks are approximately 50 feet below grade with a 4-foot thick concrete deck over the vessels. This effectively prevented the escape of fission neutrons or prompt gamma radiation from the reaction into operating areas.

Limited visual inspection and tests indicate that no significant property damage resulted from this incident, and the losses were approximately \$60,000, the cost of recovering contaminated uranium solutions resulting from the incident. Upon completion of processing of the special nuclear material related to the incident, the uranium material balance deficiency was 0.8 kg with an associated measurement uncertainty of \pm 0.7 kg. The recommendations of the committee have been complied with and additional procedures have been implemented to provide other safeguards against this type of occurrence.

B. FINDINGS

Operational Background

Since mid-July 1959, the ICPP had been engaged in processing stainless steel types of highly enriched uranium fuels. This operation

involves dissolution and a single extraction cycle in equipment installed in Cells E and F (Figure 1) especially for these fuels. Two subsequent extraction cycles are carried out in equipment which is common to process systems other than the stainless steel headend. Because extraction capacities for the second and third cycles are several times the stainless steel headend rate, it is standard operating practice to store the first cycle product which is a radioactive solution of uranyl nitrate of a concentration of 150 - 250 grams uranium per liter. In this case the critically safe storage vessels in B cell were used. These storage vessels consist of two banks (designated B-100 and B-110) of eight 5-inch diameter by ten foot-high pipes connected as illustrated in Figure 2. Each vessel is vented by a 1-inch (0.734 inch I. D.) tube at the top which leads to a 1-inch manifold of the vessel off-gas system for B cell. This vessel off-gas system is maintained at a vacuum of a few inches of water and discharges to the plant stack. The only previous use of the B cell storage banks, since installation in 1952, was for temporary first cycle product storage in B-110 of 75 kg (approximately 70 per cent of maximum volume) highly enriched uranium solution in July 1952 and 11.5 kg uranium in December 1956 and a total of 15 kg uranium in both banks in December 1957. The only significant modification made in this equipment since installation consisted of interconnecting the two banks via the bottom drain manifolds.

As additional background for later discussions, a brief outline of the waste handling systems is also given here. The aqueous raffinate solution from the first cycle extraction column is transferred directly from the hold tank in the processing cells to underground permanent storage tanks. Overheads from evaporation of intermediate product solutions and other similar radioactive process waste solutions are routed alternately to one of two 5,000-gallon process equipment waste (PEW) collection tanks where they can be sampled and assayed for uranium values prior to being sent on to the main plant waste evaporator for concentration and then to permanent underground storage. Since the ICPP is a direct maintenance plant, there are provisions for transferring decontaminating solutions, either directly from each vessel or by transfer through two or more vessels, to this same PEW system. Basically the waste collection system consists of a 6-inch pipe header extending the full length of the process building with usually two subheaders from each of the several cells.

A similar system of two 5,000-gallon tanks and feeder piping, called the Cell Floor Drain (CFD) system, parallels the PEW system and collects laboratory wastes and other solutions unlikely to contain uranium. All four waste collection vessels are located in two cells at the lowest elevation at the south end of the process building and are vented through a common 3-inch pipe to the main vessel vent header. Details of the systems are illustrated in Figures 3 and 4.

Events Leading to the Incident

Since the critically safe storage banks in B cell were approaching the working limits of 80 per cent full, a decision was made on the day shift of October 15 to sample these banks in order to obtain density information which would permit more precise determination of liquid level using

the air purged probe type of instrumentation. Because of other operational duties, the final preparations for sampling these banks were not made until the midnight to 0800 shift on October 16, although the banks were sparged for a period of approximately ten minutes on the afternoon of the 15th. Standard operating procedure for sampling requires 30 minutes of agitation by air sparging prior to sampling and continued sparging during 15 minutes of solution circulation through the sampler. The air spargers are 1/2-inch pipe with the lower ends plugged. Two 1/8-inch diameter holes are drilled through the pipe walls 1 1/8 inch above the bottom of each vessel in the storage bank. The air line pressure upstream of the sparger valve is 50 psig. Several years ago flow restricting orifices had been installed in similar sparge lines elsewhere in the plant, but installation in the B-100 and B-110 lines had apparently been deferred because of limited cell use. At about 0230 operators H and G (see Table I) each turned on an air sparger in one of the two banks (B-100 and B-110). As was customary operating practice, the B-100 air sparge valve (manual globe valve) was turned by H sufficiently to be reflected by two pounds of indicated gauge pressure and slight oscillations of the pen on the density recorder. Then he went about other duties in the operating and sampling corridors. However, as operator G turned the B-110 sparge valve control (remote pneumatic valve), he noticed that the line pressure gauge on the panel was not operating. Another gauge for this line had been installed near the cell wall, but neither operator was aware of this. Consequently, he closed the valve and reopened it cautiously until the desired movement of the density recorder pen was observed, then returned to his station at E and F cell panel (see Figure 12).

The instrument chart records of liquid level and density (see Figures 10 and 11) indicate that shortly after the start of sparging the liquid level in the B-100 bank dropped uniformly for about the next fifteen minutes, reflecting the loss of liquid from the bank through the waste line to the 5,000-gallon waste storage tank WH-100. Based upon experiments in this equipment, it appears that excessive sparge air introduced to the system and the existence of nonuniform solution density in the banks forced the solution over the protecting hydrostatic pressure barrier formed by extension of the transfer line four feet above the highest liquid level in the banks and started the siphon. From the evidence it is apparent that the steam jet, the normal transfer means through this line, was not operated at any time during the hours preceding the incident.

On the 0800 to 1600 shift of October 14, the diversion spout for the PEW system was switched from the almost full WG-101 tank to the empty WH-100 tank. It was into this latter tank that the uranium solution from the B cell storage banks drained. Figure 4 shows schematically the relative location of storage banks to the waste collection tanks.

The Nuclear Incident

Approximately 200 liters of solution at an approximate concentration of 170 grams uranium per liter moved to the waste system at an average rate of about 13 liters per minute. Prior to this time the waste tank (WH-100) contained about 600 liters of dilute aqueous waste solutions with negligible uranium content (see Table V). Upon achieving transient conditions of fissionable mass, moderation and geometry, the system went through criticality and returned to a subcritical state under conditions unknown to and unsuspected by operating personnel. The actual mechanism or duration of the excursion is not determinable from available information, but sufficient energy resulted to cause transfer of 600 liters of a total of approximately 800 liters from the WH-100 tank to the WG-101 tank and to force the diversion box spout (see Figure 13) into a position draining into the WG-101 tank. The possible routes for this transfer include interconnecting jet lines of 1 1/2-inch diameter, the 6-inch fill line back to the diversion box and 2-inch vent lines.

The magnitude of the excursion has been set at 4×10^{19} fissions based primarily upon radiochemical analysis for Mo^{99} in the resulting solution. A neutron flux density of approximately $1.5 \times 10^{13} \text{ n/cm}^2$ was estimated by Fe^{59} and Co^{58} activity in a stainless steel nut and bolt obtained from the vicinity of the reaction (see Exhibit A). There were no radiation detectors located in the tank cell because of the normally high background radiation present. It is likely that gaseous and air-borne contamination moved out via vent lines and drain connections into operating areas where continuous air monitors and radiation level monitors were located. The nuclear incident and resulting pressure wave or waves back through the waste system and possibly the vessel off-gas system spread radioactivity through the building in a path from bottom to top and generally from south to north triggering radiation alarms and prompting evacuation of the building.

Post Incident Activities

The evacuation of the building by operating personnel was quite orderly although the fact that the evacuation alarm was not sounded required telephone followup to notify personnel who were in adjoining or other buildings and had not heard the radiation alarms and the verbal evacuation orders. The process building was evacuated within about 2 minutes after establishment of an emergency condition although not by prescribed emergency evacuation routes. (For details see Section II-D and Figures 5, 6, 7, and 8.) Outside the building and for 130 yards west to the area entrance the radiation field was 5R/hr or greater (see Figure 14). Personnel were evacuated to the MTR/ETR area (two miles west).

Following the evacuation and the dissipation of the high levels of airborne activity, personnel re-entered the building approximately 45 minutes after the incident and accomplished an orderly shutdown of equipment.

The circumstance of a recent Rala run presenting the likelihood of air contamination and the absence of any apparent indication of a nuclear

reaction prior to qualitative analysis of fission products confused the identification of a criticality incident. As additional information became available relative to the incident, appropriate and conservative action was taken to forestall any further nuclear reaction, to salvage fissionable material and to assess the magnitude, causes and results of the incident. Recovery of the uranium from process and cleanup solutions related to the incident showed an unaccounted for quantity of 800 grams with an associated measurement uncertainty of \pm 700 grams. In view of previous experience, the apparent imbalance was attributed to undetected holdup and was judged not to present a nuclear hazard.

Radiation Exposures

The Chief, Medical Services Branch and the Director, AEC Health and Safety Division, among others, were notified immediately of the radiation incident and the evacuation of the ICPP. Radioactive iodine from the Rala run was the prime suspect initially. Consequently, after personnel decontamination and an initial neck survey, which indicated internal radioactivity, potassium iodide was administered orally to 14 persons in order to minimize radioiodine uptake. Later in the morning it was clearly established that the radiation exposure had resulted from a criticality incident in the CPP.

Bioassays of personnel involved in the incident were made. No blood sodium activation was found indicating there were no neutron exposures. Blood cell counts have not shown changes attributable to radiation. Therefore, the radiation exposure must necessarily have been below 100 rem and probably below 50 rem. This agrees with the findings from film badge dosimetry and calculations on internal radiation exposure where the highest skin exposure was 50 rem and the highest penetrating exposure was 8 rem. The largest internal exposure was calculated to be 29 mrem. (See Tables I, II and III of the Appendix and Section II-D for complete tabulation of personnel exposure data and additional detail on evacuation routes, spread of contamination beyond the ICPP area, etc.)

C. CONCLUSIONS

1. A nuclear excursion of the order of 10^{19} fissions occurred in a process equipment waste tank of the ICPP about 0250 on October 16. It resulted from the accidental transfer of about 200 liters of uranyl nitrate solution containing about 34 kg enriched uranium (91 per cent U-235) from critically safe process storage tanks to a geometrically unsafe tank through a line normally used for waste transfers. It appears that siphon action from the storage tank to the waste collection tank was initiated by introduction of excessive sparge air to the storage tanks. The influence of nonuniform densities and the dynamic relationships of sparge air flow and vessel venting are discussed in additional detail in Section II-B of this report.

Although no specific instances of maloperation were found, the lack of critical analysis of the operating equipment for possible sources of trouble (e.g., air lines without flow restricting orifices, valving of lines from critically safe to critically unsafe vessels, and pressure gauge installation unknown to operators using the equipment) and the lack of careful attention to initial operations in seldom used equipment represented significant errors of omission in a plant as complex as the ICPP.

2. The evacuation and other emergency procedures followed were generally adequate and effective and no doubt were instrumental in minimizing personnel exposures which could have been encountered. The failure to sound an evacuation alarm and other deviations from emergency procedure (e.g., specified evacuation routes not being followed) did not result in any harmful consequences; however, the committee believes that some recommendations for improvement are warranted, and these are included in a subsequent paragraph of this section.
3. In the ICPP and any other facility which remotely and without visual observation handles fissionable material, particularly in solutions or other non-discrete forms, personnel must be especially cognizant of the particular set of circumstances, albeit remote, which could circumvent the criticality control procedures.

There are probably few other industrial or laboratory operations where it is so axiomatic that the price of safety is intensive, eternal vigilance. The coincidence of three major nuclear incidents in the Atomic Energy Commission in a 16-month period after many years of incident-free experience in this type of operation should represent the greatest possible argument for additional efforts in this area. While in this instance it was reassuring that no major personnel exposures resulted from a relatively large excursion, the security of shielding and protective devices is no substitute for prevention.

D. RECOMMENDATIONS

Based upon its review of the circumstances of the incident, examination of available evidence, and discussions with personnel directly or indirectly involved and mindful of the advantage accruing by virtue of its "hindsight" position, the committee has the following recommendations to make for consideration at the Idaho Chemical Process Plant or any other site where applicable.

1. Equipment, including process piping, instrumentation and associated items, should be subjected to an intensive, detailed analysis and evaluation prior to initial use or reactivation after significant down time or modifications. Within reasonable economic limitations a real effort should be made to have several lines of defense against inadvertent fissionable material transfers or at least a warning means of such occurrences. It is not at all clear that an orifice in the air line would have prevented excessive pressure; however, it is apparent that an orifice, plus a properly calibrated sparge air

measuring device, plus a valve in the transfer line, along with pertinent detailed instruction, would have essentially eliminated the likelihood of the transfer. It was noted that the ICPP Operations personnel recognized the need for the valve in the transfer line and prior to the incident had initiated action to correct this deficiency.

2. Operating procedures likewise should be subjected to a continuing review to assure that they are consistent with the latest equipment and process changes and that they are completely understood by personnel. While keeping detailed procedures complete and up-to-date is acknowledged as a major undertaking, the lack of sufficiency in this area and the lack of associated timely communication of these procedures to personnel concerned can contribute significantly to the likelihood of a processing accident.

Here again it is not established that more complete procedures or instructions would have eliminated the possibility of accidental solution transfer. Nevertheless, the fact that the pressure gauge defects, orifice omissions, and the resulting need for careful adjustment of sparge air flow were not common knowledge added another link to the chain of events which led to the incident.

3. Radiation warning and evacuation procedures should be re-evaluated in the light of this emergency experience which involved less than 10 per cent of the number of persons who would have been present during the day shift. A general lack of serious concern on the part of operating personnel over initial alarms was noted. This seemed to stem partly from the acknowledged regularity of alarms that did not reflect a general radiation hazard in the plant and to some degree from a confusion over the interpretation of alarm signals of various kinds. This confusion in turn resulted from the use of similar, or in some cases identical, sounds for radiation detectors and process controls.

The experience of the incident and the possible consequences of another such event where circumstances would be different indicate that the following items deserve study and subsequent action:

- a. Separation of radiation alarms and process signals to prevent misinterpretation.
- b. Definition of responsibility for action with every radiation alarm even though that action is only to determine the validity of the alarm.
- c. Intensification of the education program to combat the possibility of "familiarity breeding contempt" for radioactivity in a plant such as the ICPP.

- d. Reconsideration of the procedure for sounding the evacuation alarm, especially with a view toward making it mandatory and less restrictive. The desirability of multiple radiation alarms automatically activating the evacuation alarm should be investigated.
- e. Re-evaluation of the evacuation routes and the ease of egress from the building to assure minimum exposure to hazards of all types, taking advantage of information and experience on probable occurrences and reactions.
- f. Consideration of the placement of neutron detection means for the entire plant, including areas where the probability of nuclear incidents is regarded as remote or insignificant.

In Section II-F of this report a summary is given of the specific actions taken at the ICPP as a result of this incident and related information.

E. ACKNOWLEDGMENT

The committee wishes to acknowledge the wholehearted cooperation and assistance of the Phillips Petroleum Company personnel in facilitating the committee's investigative effort. Special thanks are due Mr. Frank Vance and his Ad Hoc Committee, who conducted a Phillips' investigative effort into the incident; Messrs. S. G. Forbes, J. R. Huffman, R. B. Lemon, W. B. Lewis, W. E. Nyer and A. H. Spano of Phillips, who provided consulting assistance in the nuclear analysis of the incident; Messrs. J. A. Buckham and H. V. Chamberlain of Phillips, who conducted the B cell hydraulic experiments; and W. H. Burgus of Phillips, who performed radiochemical analyses and calculated neutron release and intensities.

F. SIGNATURE OF THE COMMITTEE

This report represents the combined efforts of the members of the investigating committee and the findings, conclusions and recommendations are concurred in by the members as witnessed by their signatures below:

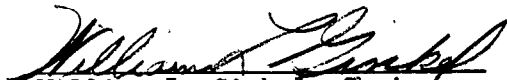
William L. Ginkel, Chairman
Assistant Director, Technical
Division of Operations
Idaho Operations Office, USAEC

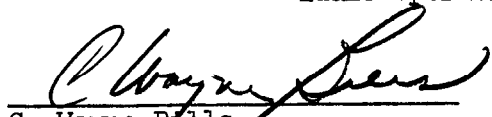
C. Wayne Bills
Deputy Director
Division of Health and Safety
Idaho Operations Office, USAEC

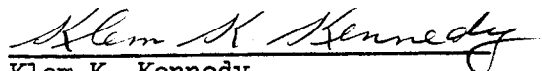
Klem K. Kennedy
Chief, Chemical Processing Branch
Division of Operations
Idaho Operations Office, USAEC

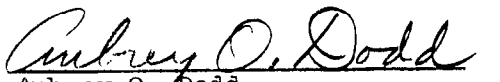
Aubrey O. Dodd
Nuclear Safety Engineer
Division of Health and Safety
Idaho Operations Office, USAEC

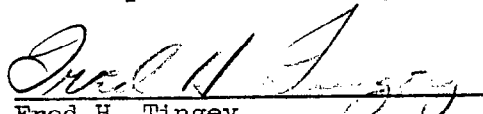
Fred H. Tingey
Division Technical Consultant
Phillips Petroleum Company
Atomic Energy Division

SECTION II - SUPPLEMENTAL INFORMATION

A. OPERATIONAL ASPECTS

INTRODUCTION

The Idaho Chemical Processing Plant was constructed at the National Reactor Testing Station, Idaho in 1950-51 as a demonstrational production plant. That is, the relatively small quantities of fuels available for processing were to be processed for recovery of enriched uranium, but process development and demonstration was a major consideration in the operational planning. The initial equipment installed was designed primarily for recovery of aluminum alloy fuels such as the MTR-type fuel but included one special purpose headend for EBR-I core processing. Several spare cells were constructed for later installation of specialized headend systems for later fuels or for testing of more efficient processes.

By 1959 five of the six spare processing cells had been occupied with equipment for processing zirconium and stainless steel-clad fuels, a high-capacity, continuous dissolution system for aluminum fuels and an isotope recovery system (Rala). Each addition to the system involved tie-ins to the existing extraction chain, waste disposal and ventilation systems, utilities, etc.

With the present complex system, processing involves charging fuel elements into one of the several dissolvers for dissolution. The acidic dissolver solution is adjusted to the desired chemical composition and then is passed through three cycles of liquid-liquid solvent extraction.

The continuous dissolution system for aluminum fuels and the zirconium-stainless steel systems contain one solvent extraction cycle as a part of the headend. Partially decontaminated product solutions from these headends are generally stored until enough is accumulated to permit most efficient operation of the later extraction cycles. The accident herein described involved this intermediate product solution from the processing of stainless steel clad fuels. Figure 1 shows the operations carried out in each of the various cells.

CRITICALITY CONTROL PRACTICES

Geometric Control

Wherever feasible, equipment that handles significant quantities or concentrations of uranium and equipment one process step removed from concentrated solutions is built to such dimensions that it is impossible to reach a critical mass. Examples of this are the continuous dissolver in G cell, the 5-inch diameter storage vessels in B cell and raffinate collection vessels in U, W and Y cells.

Concentration Control

Such fuels as the highly enriched aluminum alloy fuels contain sufficient aluminum intimately mixed with the uranium that upon evaporation any solution of the fuel will crystallize long before the minimum critical concentration of uranium is reached. Vessels handling these solutions exclusively are sized for process convenience.

Concentration control is also effective in certain areas, such as salvage operations, where precise analytical determinations of the uranium content are possible and the possibility of precipitation or other chemical reaction is very remote. Wherever possible, when relatively pure uranium solutions are involved, safety is further assured by the additional backup of mass control.

Mass Control

In certain processing and salvage operations it is necessary to handle pure uranium solutions, solutions partially separated from diluent metals or solutions in which there may be a possibility of nonhomogeneity in equipment that is not geometrically safe. In these cases the maximum quantity of uranium handled at any one time is limited to 800 grams.

Administrative Control

In order to minimize the possibility of human error, numerous procedures have been devised to insure that each and every decision which could lead to loss of uranium or to a dangerous condition is checked by two or more persons.

Detailed run sheets providing check points and guide limits require the approval of the shift foreman at critical steps. For salvage operations and other transfers not in the normal processing chain, special detailed procedures are provided by the Process Engineering Group. The foreman is required to check all analytical determinations and approve all movements of uranium-bearing solutions.

Process alarms are used throughout the system to warn of abnormal conditions of specific gravity, solution flow, tank volumes, pressures, etc.

Most solution transfers are accomplished by steam jet ejectors. In the cases where uranium might be lost by operating the steam jet, the steam valve handle is painted red. If a dangerous condition might result, the valve handle is painted orange. As further assurance that the consequences of such a transfer have been considered, these valves are either sealed or locked so that the operator is required to get permission and the specific key from the foreman before the transfer can be made. The sealed valves are those normally used only during system decontamination.

BACKGROUND TO INCIDENT

Since mid-July the CPP had been engaged in processing irradiated stainless steel type fuels. Because dissolution is the slowest part of this

process, it is expeditious to perform the dissolving operation and only one cycle of solvent extraction at this low rate. The partially decontaminated uranium product solution, now separated from cladding and alloying metals, is stored in somewhat concentrated solution until a sufficient quantity is accumulated to permit operation of the second and third solvent extraction cycles at a rate several times the maximum dissolution rate.

Dissolution and first cycle extraction (for stainless steel fuels) were carried out in E and F cells. The intermediate product from this operation was transferred batchwise in increments of about 8 liters to geometrically safe storage vessels in B cell by steam jet ejector.

At the same time that these headend operations were being carried out in E and F cells, some piping modifications and improvements were being made to the second and third cycle extraction equipment in cells Q and S.

The B cell storage vessels consist of two banks of eight 10-foot high by 5-inch schedule 40 pipes connected as illustrated in the simplified sketch of Figure 2. During the first few transfers of intermediate product from F cell to B cell, a cautious approach to flowsheet concentrations resulted in some rather low density (low uranium concentration) solution being admitted to B cell storage vessels. The nature of this equipment is such that this less dense material filled the transfer lines and thus constituted the bulk of the material in the hydrostatic seal of the bank at the time of sparging.

Since both of the banks were to be used to store product from the stainless steel fuels, the bottom connection between banks was left open to allow both to fill simultaneously. The actual operating procedure was to close the interconnecting valves, make a transfer, confirm the volume transferred by measuring the volume received in the B-100 bank, then open the valves and allow the banks to equalize again.

After the first few transfers, operating procedures were fixed at conditions that resulted in an average product solution specific gravity of 1.26 as collected in B cell banks. Processing continued in this manner until process instrumentation indicated that both banks were over 70 per cent full. Eighty per cent full is the usual maximum working level for this type of vessel.

Liquid level and solution specific gravity instrumentation provides differential pressure measurements of continuously purged dip tubes in one pipe of each bank. Consequently, with solutions of varying specific gravity being admitted in small increments through a bottom header, the specific gravity recorded by the instrument is not necessarily representative of all eight pipes of the bank. Solution samplers draw from pipes other than the ones in which the instrument probes are located so laboratory determinations of sample specific gravities can add considerable confidence to volume determinations.

SEQUENCE OF EVENTS

By October 15 the storage banks in B cell had reached an indicated level of 74 per cent full (61 per cent chart reading). Because of the inherent uncertainties in volume measurement in this type system as well as some recent erratic action of the instruments (due to crystallization at the probe tips), it was decided to sample the banks for a laboratory determination of solution specific gravity which in turn would permit more precise determination of the liquid level in the vessels. Both B cell banks were air sparged for mixing for about ten minutes during the day shift; however, the press of other duties did not allow sampling at that time. Instructions were left for the samples to be taken prior to 0600 the next day.

The 1600 to 2400 crew started to intermix the contents of the two banks by pumping from one bank and discharging into the other. Upon review of the situation, the shift supervisor determined that the pump discharge was isolated by a single remotely-operated valve from an extraction cell in which maintenance work was being performed. This was considered as inadequate protection against contamination of the extraction cell or loss of product, so pumping was discontinued as soon as operability of the pump was established.

By about 0230 a point was reached where they could proceed with sampling of B cell solution. Operator H was assigned the task and was accompanied to the B cell control panel by operator G. Operator H turned on the B-100 bank sparger while operator G turned on B-110 air sparger. Each followed the customary procedure for this operation except for changes necessitated by equipment irregularities noted at the time.

B cell vessels were first installed as part of the equipment for processing EBR-I fuel. In that system the B-100 bank was used for holdup of flush and decontamination solutions. These operations were not part of the regular processing cycle, so the air sparge controls for this bank were located at the piping manifold with a manual control valve. The B-110 bank was used for accumulation of dissolved fuel; and consequently, the sparger control was by panel-mounted remote-valve operating station similar to other frequently used controls.

The remote sparger controls consist of an on-off air switch, a reducing valve to adjust the pressure applied to the remote regulating valve, a pressure gauge to indicate the control air pressure applied and a gauge to indicate the air pressure applied to the sparger.

To prevent inadvertent application of excessive air pressure to the spargers by operating the air switch before determining the position of the control air reducing valve, flow restricting orifices were installed in the sparger lines of all small diameter vessels then in use, regardless of type of control valve, in mid-1954. Apparently due to the inactivation of B cell at that time, these orifices were not installed in B-100 and B-110 sparge lines.

The usual sparging procedure with systems containing the flow restriction was to open the air valve until the line pressure increased by two to four psi, as determined by solution depth in the vessel, then to observe the vessel specific gravity recorder oscillation to ascertain that sparging was actually occurring and that conditions were normal before leaving the controls.

In this particular case each operator approached his task as usual; however, as the B-110 sparge valve was opened, the operator noticed that the line pressure gauge was not operating. A gauge had been installed on the air line near the cell wall (see Figure 12), but neither operator was aware of this. Consequently, he closed the valve and reopened it cautiously until the desired movement of the specific gravity pen was observed. When questioned later, the operator was not certain of the exact control pressure that was applied to the valve as his attention was concentrated on the line pressure gauge. It was his belief that the control pressure approximated line pressure in similar installations, so it is believed that not over five or six psi could have been applied before the malfunction of the line pressure gauge was noted. The remote pneumatic valve had a 3 - 15 psi operating range. The other operator adjusted B-100 sparge pressure to two psi above gauge zero (gauge zero was at the two psi mark on a 160 psi scale), noted that the specific gravity pen oscillation was normal and proceeded to prepare for sampling.

About 15 minutes later (as determined by review of records) at 0250, radiation alarms throughout the building started to sound, and all persons within the process building evacuated. The shift supervisor at that time was in the instrument shop with the instrument mechanic and did not hear the radiation alarms but was notified by phone from the guardhouse that there was a release of activity in the process building and that all other persons had evacuated. Consequently, he and the instrument mechanic left the building without sounding the evacuation alarm.

Because of the apparent general contamination of the CPP area and persons involved, everyone, including the guards at the plant entrance, was evacuated to the MTR for monitoring and decontamination. Details of the evacuation are given later (see Section II -D).

Within 45 minutes of the evacuation a small group consisting of process operator G, shift supervisor M, utility operator Q, and health physicists F and L was able to re-enter the plant briefly to shut down the process that was still in operation, B cell spargers, the boilers and ventilation supply fans; the ventilation exhaust fan was left operating.

A Rala run had been completed on the afternoon of October 15. This process involves the separation of radiobarium from short-cooled MTR fuel elements. Dissolution of these short-cooled elements and even later disturbance of solutions in post-run cleanup usually cause some release of fission product iodine to the process vent

system. On some occasions iodine has escaped to the access corridor and PEW control room in sufficient quantity to set off the sensitive air monitor alarms in those areas. Consequently, it was natural initially to suspect that the release of apparently short-lived air-borne activity was in some way related to the Rala equipment. This assumption seemed to have been further substantiated by the fact that: the Rala process instruments indicated that a pressure surge had occurred, no other instruments that were observed in the hurried re-entry showed evidence of more than minor disturbance, and high level (greater than 25 R/hr) contamination was discovered around the Rala slug chute. High level contamination noted in the PEW control room was a reasonable consequence of a pressure surge initiated in the Rala system.

By 0800 emergency field equipment had been set up, a headquarters had been established in a trailer unit at the junction of Cleveland and Lincoln Boulevards (see Figure 15) and sufficient CPP Health Physics and Operations personnel had been organized to proceed with investigation of the cause of the release. Also samples from contaminated clothing and body fluid samples from exposed personnel had been collected for radiochemical analyses. Although radiation levels generally had decreased considerably by this time, the evidence still seemed to point to the Rala equipment.

At about 1000 a report of Sr-91 (9.7 hour half life) was received from the laboratory. This was the first indication that the incident might have been of nuclear origin. Immediate instructions were issued that no one was to enter the process building until the situation could be re-evaluated. Substantial verification of a criticality incident came an hour or so later when Ba-139 (85 minute half life) was identified.

In view of these developments attention was directed toward areas containing significant quantities of uranium. A small scouting party entered the plant to investigate the areas not formerly suspected. At this time it was discovered that B cell storage tank liquid levels had dropped nearly 30 per cent, and more significance was placed on the disturbance indicated by the PEW tank charts.

The Rala operator who investigated the PEW area noted that vessel WG-101 was 82 per cent full and that waste was still being received in that vessel. He diverted the stream to WH-100 which was only about 3 per cent full so that no further attention would be required in the next several hours.

RECOVERY ACTION

The B cell and waste collection tank charts were recovered for careful examination. Although the PEW diversion spout (Figure 13) was found directed to WG-101 immediately after the incident, the 1600-2400 shift on October 15 had reported that they had switched to WH-100 and the instrument chart (Figure 9) verifies that WH-100 had been filling. At the time of the incident WH-100 volume decreased from about 10 per cent (795 liters) to 3 per cent (76 liters), and WG-101 volume increased from

76 per cent (13,900 liters) to 79 per cent (14,500 liters). WG-101 continued filling after the incident. From this it could only be assumed that both tanks would contain uranium. B-100 and B-110 charts (Figures 10 and 11) indicated that 200 liters of solution had left the vessels, and this volume was estimated to contain 34 kg of uranium.

From detailed review of available information, it was concluded that the WH-100 tank must contain an appreciable quantity of uranium at a concentration between the B cell concentration of about 170 g. U/liter and around 20 g. U/liter which would have been the concentration if uniformly mixed with the previous contents of WH-100. For any condition within these limits, further addition of water could result in a more reactive condition that might effect a repetition of the criticality. Consequently, the diversion spout was returned to the WG-101 position while a complete plan of action was being formulated.

WG-101 was agitated, sampled and found to contain 8 kg of uranium at a concentration of 0.5 g. U/liter. By difference then WH-100 could contain up to 26 kg of uranium. A sample could not be drawn from the small volume remaining in WH-100.

After due consideration of the potential for recreating a critical incident because of such improbable conditions as nonhomogeneous solution, oxide formation, crystalline UNH adhering to the tank walls, etc., the following plan of action was formulated:

1. While agitating WG-101, transfer WH-100 to WG-101 to dilute the uranium to subcritical concentration. From calibration data the jet heel left in WH-100 should be about 50 liters.
2. Add 160 liters of dilute nitric acid containing 10 g./l boron as boric acid to WH-100. This volume of poison solution was calculated to stay well within minimum critical values even without mixing.
3. Install a sensitive neutron counter at a point of minimum shielding from WH-100. This was in a pump pit where shielding was about two feet of normal concrete.
4. Transfer WH-100 to WG-101.
5. Add 160 liters of nitric acid-boric acid solution to WH-100.
6. While sparging WH-100, transfer the contents of WG-101 to WH-100 in convenient increments with prolonged sparging between increments until the entire contents of WG-101 was transferred. The first increment was to increase the depth in WH-100 to no more than 12 inches until the uranium in solution in WH-100 was adequately poisoned. The subsequent incremental transfers were to insure that the poison was thoroughly mixed with each increment of depth that might dissolve significant quantities of uranium from the vessel walls.

Samples were to be taken after each transfer and to be analyzed for uranium before proceeding with the next step. The entire procedure as outlined was completed by 0120 on October 18.

It is interesting to note that after two transfers from WH-100 to WG-101 (step 4) only 6.6 kg of uranium had been transferred; however, after transferring the large volume from WG-101 to WH-100, the uranium concentration increased further by an amount equivalent to 10 kg U. Data are insufficient to determine which mechanism resulted in this improbable distribution of uranium.

While the above six steps were being carried out, the two CFD tanks were sampled and found to contain 182 grams and 450 grams (later samples indicated only 385 grams in the second tank) of uranium, respectively, indicating that little uranium had been transferred by way of the tank vent system.

In order to isolate the large volumes of uranium-bearing solution and provide space for rinses of the other parts of the system, a temporary line was run to a spare 30,000-gallon zirconium process waste tank WM-105. All waste solutions containing recoverable uranium were then transferred to WM-105, agitated and a composite sample taken for analysis.

From a detailed review of past processing data the estimate of uranium that moved from B cell was revised to 33.7 kg with an apparent imbalance of 5.5 kg. Details of the material balance are given in Section II-E.

Since it is impossible to get an accurate measurement of the quantity of uranium remaining in the B cell vessels, that material was processed through the second and third extraction cycles and measured as final product. The combined rinses held in WM-105 were then returned to process by way of the aluminum fuels continuous dissolver and processed through the TBP extraction system using a special flowsheet for the very dilute feed.

OBSERVATIONS FROM INVESTIGATION

PEW Diversion Spout (Refer to Figure 13)

It was noted that previously the flow had been directed to the empty tank WH-100. This fact was verified by the increase in WH-100 liquid level between 1800 October 14 and 0250 October 16. Later the diversion spout was found to be directed to the nearly full tank WH-101. It was clearly established that a mechanic had been in the vicinity of the diversion spout control for a period immediately preceding the incident (and the time of the change of the diversion spout) and that no operations had occurred in that area for a period considerably longer than the uncertainty in the instrument chart time scale.

In later tests it was determined that a force of only about two pounds was required to lift the diversion spout control arm high enough to disengage the locking pin which would permit the spout then to rotate freely. Very slight pressure was required to rotate the spout.

From these tests and other information, it was concluded that the rapid ejection of fluid (either gas, vapor or liquid) from the WH-100 impinged upon the diversion spout with sufficient force to lift the control rod and disengage the locking pin. Resultant forces were in such a direction as to cause the spout to swing to the opposite position toward WG-101. When the forces subsided, the operating rod dropped back into the opposite position and allowed the locking pin to engage the hole in the locking plate. When observed later by the reconnaissance crew, the mechanism was in the exact position that would be expected had it been deliberately set for flow to WG-101.

It is probable that this simple mechanism was a major factor in preventing either the return of ejected material or the flow of additional fissionable material and/or moderator into the WH-100 tank and more serious consequences.

Equipment Deficiencies

A combination of events beginning with the original plant construction in 1951 led to a series of minor and singly innocuous undesirable features which, when combined, contributed to the nuclear excursion.

In the original construction only waste solutions were to be contained in the B-100 bank of vessels. Thus uranium-bearing solutions in B cell were twice removed from the critically unsafe waste system. That is, the only way for solution to get from the B-110 bank to waste was by steam jet transfer to the B-100 bank then by another steam jet transfer to PEW. The latter transfer line is the one through which siphoning occurred.

In 1954 the dissolution and first cycle extraction equipment for zirconium and stainless steel-type fuels was installed. Rather than match these headends to the existing second and third cycle extraction, the product from the first cycle was routed to B cell for intermediate holdup. By the minor piping change of joining the bottom manifolds of the two banks of vessels together, it was possible to use both banks for intermediate product storage without further dilution by a steam jet transfer between banks. It was convenient to make this interconnection the suction line to the second cycle feed pump. Consequently, a portion of this line is the original pump feed piping consisting of 3/8-inch tubing and two 1/4-inch valves while the new piping added is 1/2-inch pipe with a 1/2-inch valve.

Each B cell bank has a 1-inch tubing vent header. However, the two tubes join some 15 feet above the banks in A cell and after about 30 more feet of 1-inch tubing enter a raschig ring packed moisture disengagement chamber, thence are joined to the main 6-inch vessel vent header through a 2-inch pipe. Under the original scheme it was very unlikely that the B-100 bank would ever be in use at a time that the B-110 bank contained uranium solution, so the joining of the two vent lines did not constitute a restriction.

During 1954 it was decided that flow restricting orifices should be installed in the sparger air lines to all the geometrically safe storage vessels in the plant to prevent inadvertent application of excessive sparge air which had been found on occasions to carry small amounts of liquid into the off-gas system. In the two-year period between completion of construction and the first operations of either the zirconium or stainless steel system, the sparger orifices for B cell vessels were overlooked.

During B cell hydraulic tests described later (Section II-B) the operation of the pneumatic valve which controls sparging air to the B-110 bank was quite erratic. On some occasions the slightest adjustment of the control air regulator would cause the valve to snap nearly wide open from an initial closed position. In fact, in the experiments it was difficult to duplicate the controlled movement of 1/8 inch of stem travel reported by the operator who sparged the vessels during the day shift of October 15. Valve stem motion was not observed by operator G who adjusted the sparger at the time of the incident on October 16.

As noted earlier the pressure gauge on the B-110 sparger control panel had been disconnected and a new gauge installed on the piping next to the cell wall. None of the operators questioned were aware of this change. As a result, those who operated this sparger had no indication of the sparging rate actually used. In fact, the initial sparging was probably quite violent before it became apparent that the gauge they were observing was inoperable. Also erratic control valve action undoubtedly contributed to the pressure surge. The traces on the B-110 instrument chart (Figure 11) indicate that the sparging on October 15 day shift was probably as violent as the subsequent sparging which initiated the transfer. On both occasions specific gravity and liquid level pens dropped below chart zero momentarily as sparge air was applied. However, since only one person operated both B-100 and B-110 spargers on October 15, it would not have been possible for both pressure surges to have occurred simultaneously. It is now apparent that siphoning through the transfer line seal loop would have been effectively prevented by the existence of a valve in the line, a vent at the high point of the loop, or an enlargement of pipe diameter beyond the high point of the loop.

Pressures Experienced

The WG-101 liquid level record shows a pressure transient of at least 100 inches of water gauge or nearly five psi during the incident. Since the main communication between WH-100 and WG-101 is via the 6-inch inlet lines and the PEW header would divert half the flow through this route, the pressure experienced in WH-100 must have been considerably in excess of five psig. The tank would be expected to withstand a pressure of 100 psig or more without yielding. Since the rate of energy released is indeterminate, it is not possible to narrow this pressure range further.

Within the above possible pressure range the 600 or more liters of liquid could have transferred to WG-101 in either the liquid or vapor phase in a period of as little as one-half minute. The time scale on the PEW liquid level chart does not permit discrimination between pen swings that

might have occurred within a period of around two minutes. Furthermore, the pneumatic instruments employed throughout the plant use the two probe system in which the atmospheric reference pressure is the pressure within the vessel served. With this type of system either a sharp pressure transient (shock wave) or a rather slow change in pressure could occur without being recorded on the instrument chart.

The time at which the one (or more) recorded pressure surge occurred or the amount of liquid transferred in either the liquid or vapor phase is very difficult to deduce. Further discussion of the mechanism of transfer is given under the section on Nuclear Aspects.

B. B CELL HYDRAULIC CHARACTERISTICS

Tests were conducted with the B cell equipment to determine the conditions under which solutions in bank B-100 could be made to accidentally transfer to the PEW tanks.

First tests were made to obtain pressure drop data on the vent system with no liquid in the vessels. The sump and PEW jets were capped so that all of the sparge air escaped through the vent system. With the sump jet not capped, sparge air can go to the sump when sparging either bank (see Figure 16). Pressure drop data for various air sparge rates were obtained and were compared to calculated pressure drops. The relationships are shown in Figures 17 and 18. Apparently no restriction such as a partial plug existed at the time of the tests in the vent lines from either bank to their common junction point or in the common vent line to vessel A-106. Data from initial scoping tests also indicated that there was no restriction in the lines three weeks after the incident occurred.

In subsequent tests the banks were filled to incident depth with nitric acid solution of approximately the same specific gravity (1.26) as the solution in the banks at the time of the incident. In several of the tests a small quantity of nitric acid solution of 1.1 specific gravity was first introduced into the banks in order to duplicate the actual procedure used when the banks were first being filled during processing. This presumably put some light liquid in the PEW transfer line. Pressure taps were installed in the vent lines (Figure 16) to measure key pressures, and rotameters were installed in the air sparge lines for use in determining air rates.

During tests made in the system with the sump return and B-100 PEW lines capped off and the vessels filled with nitric acid (same level as at the time of the incident), liquid was transferred to vessel A-104 via the knockout drum A-106 (see Figure 16). The rate of solution flow into A-104 ranged from 20 to 2000 ml per minute depending on the sparge rate. The data obtained with liquid in the system show higher pressure drops at comparable air rates than do the data obtained in the dry system. Thus it is indicated that

liquid is lifted into the vent lines by the sparge air which in turn creates additional pressure drop. Figures 19, 20, and 21 graph these data and indicate that a sparge rate of approximately 12 SCFM will begin to lift liquid into the vent system. The effect of the liquid in the lines is more pronounced for the vent lines coming off the banks than it is for the common vent line. This is to be expected because there are vertical sections in the bank vent lines while the common line is almost horizontal. Tests also indicate that when sparging is stopped or decreased, the liquid flows out of the vent lines, and normal pressure drops are again obtained with low sparge rates.

Sparging tests were made in a 4-inch diameter lucite pipe using both water and 2.2M aluminum nitrate solution to obtain the relationship between sparge rate and the amount of expansion of the air-liquid mixture. The ratio of initial height to expanded height correlates quite well with sparge rate (ft^3 per ft^2 of column cross-sectional area per minute) as shown in Figure 22. With the vessels in B cell filled to incident depth of 98 inches, the expansion ratio to put liquid into the vent system would be approximately 1.22. From Figure 22 it is seen that a sparge rate of 14 cubic feet per square foot of column cross-sectional area per minute or 15 SCFM per bank should be required. The plant scale tests, however, have shown that a sparge rate of approximately 12 SCFM is required to lift liquid into the vent system from either bank (see Figures 19, 20, and 21). A scaleup factor may account for the difference, or it is possible that one or more of the vessels in one bank may receive more sparge air than the others. In either case these data are considered to be in close agreement. As would be expected, liquid is also transferred to the sump from the B-100 bank by a sparge rate of approximately 12 SCFM.

As noted elsewhere in this report, the B-110 sparger has a motor valve in the line which is controlled by a regulating valve mounted on the panel board. The regulating valve has a pressure gauge which indicates the control air pressure applied to the motor valve. At the time of the incident this pressure gauge was inoperative. From the operator's testimony on the way the sparger was started, it appears likely that excessive sparging with the B-110 sparger started the transfer of solution to PEW. Extensive tests with the B-110 sparger have shown that generally it is not possible to start the liquid siphoning when pressure is increased slowly. Even with full header pressure of 50 psig on the sparger, this resulted in only 20 inches of water back pressure on the B-100 bank. With the B-100 sparger in operation at approximately 5 psig, quick opening of the B-110 sparge valve during tests resulted in a sufficient pressure surge to start the siphon. At the time of the incident the operator was unaware that the panel gauge was inoperative or that an operating pressure gauge had been installed in the manifold behind him. When these conditions were reproduced, i.e., steady opening of the pilot valve while ignoring the pressure gauge behind, siphoning was initiated several times. At no time was it possible to get the siphon started when sparging only the B-100 bank.

In order to start the liquid siphoning with moderate sparge rates, it was necessary to sparge the B-110 before the B-100 bank. This lifted liquid into the vent system, as evidenced by collection of liquid in A-104; and

then when the B-100 sparger was operated, the resulting pressure buildup was sufficient to start the siphoning action. Tests have shown that it is almost impossible to operate either sparger without getting an initial surge in the sparge air. The instrument charts for the two banks indicate that this was also the case at the time of the incident.

The siphoning which occurred during the testing period stopped after 11 to 14.3 minutes, and the final levels reached ranged from 22 to 7.5 per cent as compared to approximately 15 minutes and 18 per cent at the time of the incident. It was found that the siphon generally stopped with the liquid level in the vessel slightly above the level of the PEW line connection; however, this was somewhat dependent on the pressure in the vessel. During the tests a section of flexible Tygon tubing was substituted for a section of the stainless steel tubing in the PEW transfer line (just before entrance to the 2-inch line) for direct observation of liquid flow. Figure 23 gives the elevations of critical points in the system. During the siphonings the flexible tubing was partially collapsed. This increased the velocity of the liquid through the tubing and probably prolonged the siphoning. The resultant increase in velocity through the Tygon tubing section, as well as the effects of sparging and variations in vessel pressure, probably contributed to the variations in final levels reached when siphonings stopped. It is therefore concluded that the siphon at the time of the incident could have stopped of its own accord without any assistance from a shock wave as a result of the incident.

The final test made in the system consisted of setting a sparge rate of 7 SCFM in both banks (the sump and PEW lines being open) and then closing down the A-B cell VOG (vessel off-gas) valve thereby putting a definite block in the vent lines. The resulting back pressure on bank B-100 did not exceed 24 inches of water. It is apparent that there are other paths for sparge air relief in the system. These paths are more resistant than the regular lines and include the sump return line and the lines to the A cell dissolvers by way of A-104. The sparge rate on the B-110 bank was then increased to 10 SCFM. The back pressure on the B-100 bank quickly built up to 60 inches of water and the liquid started siphoning. The pressure then decreased to 20 - 25 inches of water during siphoning.

C. NUCLEAR ASPECTS

Admittedly any explanation of the nuclear reaction must be consistent with the framework of non-nuclear facts associated with the overall incident. The pertinent facts in this regard are: (1) Six hundred to 800 liters of dilute aqueous waste were in tank WH-100 just before product transfer began; (In previous sections of this report 600 liters were given as the approximate content of WH-100 prior to transfer. In reality that number represents a rough approximation at best as evidenced by the smear of the trace on the liquid level chart and the inherent inaccuracy of the instrumentation at the low scale range. For the purpose of the nuclear calculation, essentially

an upper limit of 800 liters was assumed as the original content, and an allowance was made for introduction to the waste system of dilute aqueous waste solution simultaneously with the inadvertent transfer.) (2) Approximately 200 liters at 170 g U/liter escaped critically-safe product bank B-100, and at least a major portion flowed into unsafe tank WH-100 during a period of about 15 minutes; (3) The liquid-level chart representing vessels WH-100 and WG-101 indicated a sudden disturbance in both tanks with WH-100 losing as much as 900 liters and WG-101 gaining about 600 liters with transfer occurring in several minutes' time; (4) The PEW diversion spout shifted from WH-100 setting to WG-101 as a result of the reaction, diverting subsequent process waste solution away from the unsafe vessel; (5) Post-incident calculations showed about eight kg U in WG-101, 20 to 26 kg U in WH-100, and 34 kg U loss from B cell. Also, a few hundred grams U were found in adjoining CFD tanks WH-101 and WG-100; (6) The liquid-level charts show an apparent depth increase in WH-100 from one to two per cent, possibly 40 to 50 liters, during about three hours' time following the major disturbance; (7) There was no apparent physical damage to the tanks and connections involved.

The following hypothesis is offered as the most acceptable explanation of the nuclear incident in the light of all available evidence. The application of sparge air to B cell product storage banks initiated a transfer of enriched uranium solution from the critically-safe vessels into WH-100 process waste vessel which is not design safe for such fissile material. En route the product solution traveled via the Process Equipment Waste 6-inch main where it very likely mixed with a lesser (though uncertain) volume of water. Prior to beginning receipt of product solution, WH-100 vessel contained no more than 900 liters of dilute aqueous waste having a maximum depth of about 11 inches. The receiving vessel is a horizontal right cylinder 9 feet in diameter by 9 feet long with standard dished ends. The addition of up to 200 liters of product solution and a small volume of process waste brought the depth at slab center to about 13 inches. The incoming material fell into the waste solution at a point about three feet in along the 9-foot slab length. What degree of mixing took place or what configuration the reacting phase was in at any given instant is subject to conjecture more than to measurement. The siphon transfer from B-100 was near the point of hydraulic equilibrium at the time of actual cessation. B-100 liquid-level chart (Figure 10) indicates a pressure disturbance about three or four minutes after flow had stopped. Therefore, it does not appear likely that the excursion acted to break the siphon action.

Criticality probably began about five minutes after initiation of transfer from B cell eventually generating enough pressure in WH-100 vessel to move some of its contents (via jet line) into WG-101. Also, steam entrainment carried over some uranium via jet connections, vent headers and PEW diversion box into the CFD and PEW systems. Possibly some 40 to 50 liters of condensate returned to WH-100 via the vent header over a period of two to three hours as indicated on the liquid-level chart (Figure 9). The nuclear excursion was self-limiting due to the open piping of the vessel and the existing solution geometry. This permitted dissipation of energy through the vent system and PEW main avoiding physical damage to the system.

Fortunately during the course of the incident, a pressure surge shifted the PEW diversion spout from WH-100 setting to WG-101 and prevented subsequent PEW solution from flowing in to further the reaction and effectively shut down the nuclear system.

Criticality calculations were performed by a committee of Phillips personnel (see Exhibit D). Since it was impossible to determine the degree of mixing that existed as the concentrated uranyl nitrate flowed into WH-100 vessel, the system was viewed as a succession of stationary states which defined the total amounts of U-235 and water in the vessel at chosen instants of time. Each state was subdivided into substates corresponding to a range of dilution varying from no mixing to complete mixing of the waste and uranyl nitrate solutions.

It was calculated that for each chosen state there existed a concentration for which k_{eff} is a maximum. (See Figure 24.) The far right of each curve corresponds to no mixing and the far left to complete mixing. The highest ramp rate--that for optimum dilution--is found to be of the order of $2 \times 10^{-3} \text{ sec}^{-1}$ as estimated from the cross-plots of Figure 25. Based upon SPERT experience and data available from KEWB, it is estimated that a peak power of 10^8 watts was attained. It is not likely that a single burst would account for the total number of fissions (approximately 4×10^{19}); it is more likely that the reaction continued for at least ten seconds and probably as long as several minutes. It is not likely that the system could have gone critical in less than two minutes after product solution began to flow into WH-100 when it would have contained about 4 kg U-235.

With the above assumptions in mind, it seems probable that the rate of reactivity increase was quite low at the start. After initial criticality one would presume that a reasonably effective mechanism to limit excess reactivity was available in the form of thermal effects resulting from increase in power. From the spread of fission-product contamination, it is obvious that there was considerable vapor and gas evolution. However, whether the power increase was moderate and sustained or whether there was a number of completely irregular pulses or yet, whether the reaction embraced a series of power oscillations with increasing amplitude resulting in the final surge which is thought to have shifted the diversion spout, the true picture of criticality will very likely remain more speculative than definitive.

One most puzzling phenomenon of the incident was the transfer of some 900 liters of solution out of WH-100 vessel with about 600 liters showing up in the companion PEW vessel WG-101. The question centers upon the mechanism of this transfer: via the connecting 1 1/2-inch jet line, spewing over by steam entrainment, through the 6-inch inlet lines and diversion box, and flow-back of steam condensate. These are mechanisms which have been mentioned before, all of which undoubtedly played some part in the transfer. There was only one pressure surge of sufficient magnitude to activate the

liquid-level instruments. This necessarily created a pressure considerably in excess of five psig in WH-100 since the liquid-level instrument response for WG-101 was greater than five psig equivalent.

It is difficult to account for a sustained pressurization of WH-100 of the order of five minutes to effect transfer through the jet lines. At the same time it is difficult to imagine hundreds of liters of solution being lifted out of the vessel via the 6-inch inlet line with no damage to the vessel and connecting piping. And finally, it is equally difficult to picture hundreds of liters of solution being vaporized, forced out into the PEW mains, condensing and flowing back into the waste-collecting vessel. One is tempted to postulate some action by all these mechanisms but unable to say how much by any one of them.

Liquid-level charts for the adjoining CFD vessels record a single disturbance equivalent to about ten inches of water pressure. These and the PEW vessels are interconnected by small diameter pipes. It is uncertain to what extent the vent system served to relieve pressure or transfer fluid during the reaction. It is only known that after the incident 385 g. U were found in CFD vessel WH-101 and 182 g. U in WG-100.

Another unexpected phenomenon was the amount of uranium which remained in the reacting vessel--approximately 20 - 26 kg. Thus as much as 75 per cent of the total uranium involved was retained in that vessel. For the vessel to discharge approximately 90 per cent of its solution volume but only 25 per cent of the contained uranium strongly suggests salting out of the uranium and evaporation of most of the water. Due to the peculiar details of dimensions and geometry, however, it is considered possible that little longitudinal mixing occurred, at least during the early phase of the reaction, and that pressurization forced a large fraction of low uranium concentration waste out of the opposite end of WH-100 where the jet pickup tube is situated. This would have left the mass of uranium deposited in the immediate vicinity of the inlet port.

Reference to the Material Balance Section shows that following the excursion 7.9 kg uranium were found in WG-101 and about 0.5 kg in the neighboring CFD tanks. No significant quantity of uranium was found in any other vessel or outside of process equipment which could have resulted from the incident. Transfer of the heel plus a 160-liter rinse from WH-100 introduced 6.7 kg uranium to WG-101. Then, when the large volume of solution in WG-101 containing 14.6 kg uranium was transferred back into WH-100, the measured uranium content increased by another 13.1 kg to a total of 27.7 kg. This would indicate that either a considerable quantity of uranium had crystallized or precipitated from solution and was not recovered by the very small rinse volume or that uranium in solid form had been plastered on the vessel walls above the lower liquid level.

Under favorable circumstances one can obtain considerable support from graphs of radiation monitoring instruments in defining the nuclear reaction picture. Numerous area monitors and continuous air monitors, within the 601 building, in neighboring buildings, and at CF-646 some 2.5 miles south, responded to the incident. These records are not inconsistent with the analysis already presented.

Figure 26 shows the response of a continuous air monitor (CAM) located in a room directly above the reacting vessel. The instrument has a G-M tube detector (as is the case with all others referred to herein with one exception) with approximately two inches of lead shielding the tube. It was within 20 feet of the excursion separated by approximately four feet of concrete. Inspection of the graph shows three sharp peaks within two minutes during which time the instrument shifted from low scale through mid-scale to high (2x, 10x, 20x). The decline to one or two per cent of scale follows immediately, and the subsequent low trace may be interpreted as circuit blocking from excessively high prompt radiation and/or fission product contamination. A less likely interpretation is that the subsequent low trace indicates normal tube operation on high scale with no further bursts of radiation nor instrument contamination. Due to the proximity of instrument and excursion, it is quite likely that the sudden peaks represent direct gamma radiation from prompt power rises. Whether the decline indicates that the power shutdown occurred within two minutes or that the detector was incapacitated at that point and could not respond to further bursts, one can hardly say with certainty.

Figure 27 shows the response of an anthracene-crystal photomultiplier detector located about 30 feet line-of-sight from the reaction with as much as eight feet of concrete intervening. This chart also shows two or three sharp peaks within approximately 1.5 minutes followed by an off-scale trace until chart change and scale reset. The filter papers from these close-in instruments were found to be highly contaminated, reading several R/hr about 12 hours later. This contamination, if received quickly after initial criticality, could have obscured any further prompt radiation detection (if, indeed, such occurred).

Figure 28 represents another CAM response located about 50 feet from the reaction with many feet of concrete and other attenuating materials between. The detector appears to have seen a strong radiation field which drove the chart pen off scale. Within about a minute the trace drops abruptly and remains at chart minimum indicating that it was seeing too much radiation to discriminate pulses and maintain an output potential. The erratic trace during the remaining two hours shown on this chart segment probably indicates a measure of instrument recovery as the radiation field fell off with decay of the contamination in the area.

The exact time at which each instrument first responded to radiation cannot be determined since no attempt was made to note the chart-clock synchronization when the charts were collected after the incident. This oversight is certainly excusable because the need for such detail was not obvious at the time. Even if such information were available, the accuracy would have to be very good to enable one to say definitely whether a particular response was to direct radiation from the excursion or to radiation from a rapidly ejected cloud of fission products.

Figures 29 and 30 are charts from CAM's located in the cafeteria and maintenance buildings, respectively, each approximately 400-500 feet from the incident. The similarity (of one full peak followed by three short ones) is coincidental, for the time interval involved differs by a factor of two. It is felt that these chart traces are responses to a cloud (or clouds) of fission products moving out of the 250-foot exhaust stack. Both charts show subsequent collection of contamination, especially after shutdown of input ventilation equipment at about 0400 (after which the air monitors were recirculating contaminated air from within the buildings).

Figures 31 and 32 show charts from CAM's at building 603 located about 2,400 feet south of building 601. Figure 31 shows a sharp but short rise at 3:00 a.m., a two minute decline, then a rise off-scale. This short rise is not seen on Figure 32 probably because of the instrument's location which placed the mass of the building's structural material between it and building 601. The instrument represented by Figure 31 was situated at the east end of building 603 with only a transite wall and above-stated distance between it and building 601.

One is inclined to interpret the 3:00 a.m. blip on Figure 31 as a response to scattered gamma radiation from the excursion. The subsequent rise off-scale (on both charts) through five or six minutes was probably a response to direct radiation from the passing of a large cloud of stack-discharged activity. (There is little likelihood that very much prompt gamma radiation from the excursion could have been seen by these two instruments due to the location of the reaction some 40 feet below grade as well as 2,400 feet away on the horizontal.) Once the traces begin to decline there are about six successive short rises, each reversal occupying approximately two minutes until the instruments both stabilize on scale of least sensitivity near chart minimum. These instruments indicate no significant filter contamination until about nine hours after the incident.

If the above interpretation of Figures 31 and 32 is correct, one might deduce from it that the time duration of the nuclear reaction (or at least the release of fission products by it) was between 15 and 20 minutes and that the reaction was characterized by a major power rise followed by about six relatively minor surges, each of successively diminishing power and separated from each other by about two minutes.

The last CAM chart (Figure 33) reproduced in this report shows the response of the instrument on top of building CF-646 some 2.5 miles due south of the incident. The trace from 3:00 a.m. until 4:00 a.m. may be interpreted as a response to a combination of direct radiation from passing clouds and some small amounts of contamination entering the air filter. A wind shift at about 4:00 a.m. (see Table IV) is thought to have brought in a considerable quantity of particulates which produced the succeeding characteristic decay curve. Multipoint recorder graphs of area monitors located within building 601 are not reproduced here because all of them rise to off scale and remain there for some hours due to contamination which lingered in the building.

D. HEALTH PHYSICS ASPECTS

SUMMARY

This section includes a general discussion of the personnel aspects of the CPP criticality incident of October 16. It discusses their location at the time of the incident, their reactions to warning systems, evacuation routes, incident exposures and subsequent medical evaluation.

At the time of the incident there were 21 people in or near the CPP area. A sequence of radiation alarms started near L cell in the access corridor and ended with most radiation alarms in the 601 and 602 buildings ringing within a couple of minutes. The two health physicists on duty measured greater than 5 R/hr activity (limit of the meters they were using) in the operating corridor and called for evacuation of the building. Outside the entrance to the 602 building the field was still greater than 5 R/hr and diminished to 2 R/hr in the parking area beyond the guardhouse (see Figure 14).

On reaching the vicinity of the guardhouse, the health physicists F and L made a count of personnel and determined that the shift supervisor, an instrument man and two utility operators were still inside the plant area. The health physicists used the guardhouse telephones and the inplant call system to reach these people. The shift supervisor and the instrument man were in the instrument shop office adjacent to the 602 building and had not heard any alarms. They were instructed to evacuate and informed that everyone else had been alerted. They then ran through the 602 building to the guardhouse. The utility operators arrived at the guardhouse from the boiler plant at about the same time. Personnel evacuated to the MTR area in two vehicles, one a stationwagon belonging to the AEC nurse who had just arrived at the guardhouse on a routine shift check and the other a patrol car which was parked near the plant gate.

Upon arrival outside the MTR area, the shift supervisor reviewed the personnel count and determined that operator O assigned to the 603 building had been overlooked. Attempts to contact operator O by telephone were unsuccessful. Guard R and health physicist L proceeded by patrol car to the CPP area. At the CPP guard gate they encountered Phillips' patrol officer U and advised him to leave the area. They then picked up operator O at the 603 building and returned to the MTR.

Meanwhile it had been decided that a team of two health physicists F and L, the shift supervisor M, utility operator Q, and process operator G should return to secure the evacuated plant. Arriving at the CPP guard gate at approximately 0345 (with Scott Air Paks), they found the radiation level to be about 40 mr/hr. One health physicist L and the utility operator Q went to the boiler plant,

and the other health physicist F accompanied shift supervisor M and operator G into the process building CPP-601. Radiation readings within CPP-601 were from 200 to 2000 mr/hr; however, in the Process Makeup Area the Rala dissolver charging chute at the top of L cell was reading 25 R/hr at about 18 inches.

The CPP was secured by shutdown of all process equipment and services. The process building ventilation exhaust fan was left operating. The team again left the CPP area at about 0400. Securing the plant concluded the emergency radiation exposure to the 21 persons directly involved.

PERSONNEL EXPOSURES AND EVACUATION

The external radiation exposures to those involved in the incident ranged up to 50 rem as measured by personnel film badges. The external exposures are listed in Table I, and the internal doses for the five highest exposures are presented in Table II. Figures 5, 6, 7 and 8 show locations of personnel within 601, 602 and RAF buildings as the alarms sounded. In addition, Figure 5 also shows the nearest approach of personnel to the deep tank WH-100 just prior to the incident.

The letters following the X's, which mark the personnel locations in Figures 5, 6, 7, and 8, indicate their order of exposure with A being the highest. It is generally thought that the exposure was from air-borne fission and decay products. The excursion apparently caused a gaseous surge (likely entraining some liquid as well) through the waste collection and venting systems which extend throughout the process and laboratory building.

Process operator A had removed the glass panel from in front of the sampler on C cell just prior to the general alarms. Undoubtedly this opening and other floor drains in the west sample corridor delivered the gaseous fission products to this area whence they were swept by the ventilating air current northward along the west sample corridor, down through a grating in the floor and into the vent tunnel and duct connecting to the 250-foot stack.

The evacuation route taken by maintenance man B and process operator A was the shortest route possible from the building but also was in the highest radiation field encountered by any personnel. The laboratory man C must have been just steps ahead of the highest radiation field in the west sample corridor and received a small part of his exposure during his longer evacuation route through the 602 building.

The laboratory men D and E left the building via a fire escape on the west end of the Remote Analytical Facility building and were probably the first ones outside. It appears that their relatively high exposures probably were received from the radioactive cloud in the area.

Also of interest is the similarity in exposures received by process operator H and laboratory man I since they took the longest and shortest evacuation routes respectively yet received almost identical exposures (2.9 and 2.8 rem).

The internal exposures were determined from elimination rates of activity in the urine. The only significant contributors to internal exposures were determined to be Sr⁹⁰ and Sr⁹¹. Those persons whose internal dose was less than 2 mrem were omitted from Table II. Although film badges worn by personnel involved in the incident did not contain neutron detectors, all available evidence indicates no neutron exposures were received. The best evidence for determination of the neutron activity generated was a stainless steel bolt which was recovered from within the WH-100 tank vault. Analysis of induced radioactivity in the bolt provided data for calculating a total neutron dose of approximately 0.05 rads at the surface of the floor in the PEW control room directly above the tank but with four feet of concrete shielding. The nearest personnel were in the stairwell leading to the access corridor. This location provides considerably more distance and seven feet more of concrete shielding between the personnel and the tank (see Figure 4).

A general conditioning toward plant warning signals was evident. In nearly every case there was a reluctance to respond to the first alarm signal heard. Usually two or more signals were heard before there was concern about immediate personal hazard. This conditioning was largely a result of two things, viz. (1) some radiation monitors alarmed over the same audio system as process alarms and (2) radiation alarms of a localized and transitory nature were not an unusual part of operation. The general evacuation siren never was sounded since it is activated only by the senior supervisor who was not aware of the radiation alarms until after he was notified by telephone. He did not activate the evacuation alarm at that time because he was told all personnel had been alerted. It was noted by the committee that some confusion prevailed among personnel involved concerning the nature of the evacuation alarm signal which had recently been changed from horn to siren. It is noteworthy that no one followed the prescribed evacuation route upon leaving the processing area. The evacuation route is posted conspicuously and is counter to the normal, everyday exit in order to direct personnel away from the general area of the product handling room and storage vault. (It was postulated that if a criticality incident should occur, these areas would most probably be involved.) In particular, the bottleneck of the radiation locking stiletton at the normal exit could have resulted in serious personal injury if similar procedures had been followed during a day shift evacuation when many times as many people would have been involved. Accordingly, it is the committee's view that the exit-blocking features of the turnstile monitors should be eliminated since it is unlikely they could easily be made inoperative in emergencies.

It is probable that in this particular case neither the failure to sound the evacuation alarm nor the deviation from prescribed evacuation routes resulted in appreciably higher exposures than would otherwise have been experienced. However, under different circumstances such omissions or deviations could lead to serious

consequences. Certainly a mechanism or procedure that would have resulted in timely activation of the evacuation alarm would have hastened clearing of the plant and eliminated the need for telephone notification.

MEDICAL EVALUATIONS

The Medical Services Branch chief and the AEC Health and Safety Division director were notified of the incident within ten minutes after CPP personnel had evacuated the plant. Since radioactive iodine was a prime suspect initially and a preliminary neck survey indicated internal radioactivity for some, 14 of the 21 persons concerned were given a 20-grain dose of potassium iodide in order to reduce thyroid uptake. Blood and urine samples were taken and analyzed for activity. When it was suspected that the radiation exposure had occurred from a criticality accident, the highest activity blood sample was analyzed for sodium activation and proved negative. The results of these analyses are given in Table II. Pulse height analyses on urine specimens and total body scans on personnel with the highest urine activities substantiated the absence of sodium 24.

No symptoms occurred which could be attributed to radiation exposures. A majority of the 14 persons receiving the potassium iodide developed mild symptoms attributed to iodism. The principal symptoms were sore throat, headache, and a metallic taste. These subsided within 48 hours. Employees with lesser exposures who returned to work on their next regular shift appeared to have more symptoms than those who remained home over the weekend.

Analyses of blood samples on all exposed individuals have not shown changes indicative of radiation effect. It is concluded that the radiation exposure received by these individuals was not sufficient to produce demonstrable, hematologic effects. Thus the radiation exposures are indicated to have been below 100 rem and probably below 50 rem. This agrees with the findings on film badges and calculations on internal radiation exposure as given in Tables I and II.

Environmental Control

Disposal of radioactive material released from the CPP into the atmosphere is affected by meteorological conditions at the time of release. Wind and temperatures measured at the Central Facilities Area (approximately three miles from CPP) are believed to be representative of prevailing conditions to the southern boundary of the NRTS. The buildings downwind of the CPP stack cause some shifting of the surface level winds from those measured at Central Facilities. (See Table IV.) The wind direction record during the release had the characteristic of no vertical temperature gradient and diffusion calculations were made taking this into account.

E. MATERIAL BALANCE

Immediately prior to the incident 498 liters of solution containing 83.6 ± 1.5 kg of 90 per cent enriched uranium were in the B-100, B-110

storage banks. This constituted the dissolver product from the entire stainless steel program except for approximately 3 kg held up in process and 2 kg yet to be dissolved.

On the basis of chart specific gravity and liquid level readings along with a chemical analysis of samples taken from the banks after the incident, 33.7 ± 1.5 kg of uranium were transferred in approximately 200 liters of solution. The data are summarized in Table V.

Material balances intermediate to a complete cleanout are of some interest. The identification of the incident as being a nuclear excursion suggested that a hazardous condition might yet exist in the waste tanks and in particular in WH-100. Thus before proceeding with the recovery of the material from the waste system, an attempt was made to determine the distribution of the material through the system. Accordingly, vessel WG-101 containing approximately 14,500 liters was extensively sparged and sampled in duplicate. Solution volume and chemical analysis of samples indicated approximately 7.9 ± .3 kg U in this vessel. Because of the potentially hazardous condition in WH-100, the decision was made not to sparge that tank. Although a sample was taken, its nature was such as to preclude its use in estimating vessel content. Instead a "by difference" accounting involving the total amount transferred from B cell (33.7 ± 1.5 kg U) and the amount measured in WG-101 (7.9 ± .3 kg U) indicated a possible content of 25.8 ± 1.5 kg U in WH-100. Undoubtedly much of this was in a desiccated form on the walls of the vessel. That this was the case was substantiated when the solution in WH-100 was transferred to WG-101. After extensive sparging of the combined contents in WG-101, samples were taken and analyzed. This content was estimated to be 14.6 ± .5 kg U contained in 15,500 liters of solution. (N.B. Because of limited capacity, 3,300 liters were transferred to a hold tank in D cell.) Thus, as much as 19.1 ± 1.6 kg U still could have remained in WH-100. At this stage 160 liters of 10 g./liter boron solution (as boric acid in 0.2N HNO₃) were added to WH-100. The entire content of WG-101, except for jet heel, was incrementally transferred from WG-101 to WH-100 and extensively sparged. Sample analyses and volume determinations in vessel WH-100 indicated a combined content of 24.6 ± 1.0 kg U in approximately 14,700 liters of solution. This along with 3.1 ± .2 kg U transferred to D cell and .5 ± .2 kg identified in CFD tanks gave a total of 28.2 ± 1.0 kg U accounted for. Since 5.5 ± 1.8 kg U were still unaccounted for, an extensive sweepdown of the system was initiated. The above data are summarized in Table VI. The final material balance is given in Table VII. The apparent final imbalance of .8 ± .7 kg U has application to that part of the material balance which involved solutions from which samples were taken and chemical analyses made.

While in the process of returning the large volume of solution generated in recovery operations from underground storage tanks to the process through an improvised line, a flange gasket failed and spilled an unknown quantity of the dilute solution on the ground. Because of steam jet dilution of the transferred solution, the amount lost could not be detected by a volume balance.

All contaminated soil, as indicated by radiation measurements, in the vicinity of the leak was collected and placed in two metallic boxes (118 cu. ft. Dempster Dumpsters). A .2 cu. ft. sample from each dumpster was taken and leached with dilute nitric acid. The leach liquor analyses for uranium showed negligible quantities even when extrapolated to the entire contents of the dumpsters. This measurement at best can only be interpreted as an extremely rough indication of the leachable uranium content of the dumpsters.

Thus, the apparent imbalance of .8 \pm .7 kg U can be attributed to the leak and/or additional undetected process holdup. The latter explanation seems the more likely in view of our experience and the data at hand. Quantities of uranium .1 kg or greater are usually found on repeated sweepdown.

Since a holdup of the quantity indicated by the imbalance was judged not to constitute a criticality hazard, further effort in sweepdown did not appear to be economically justified.

F. ACTION ON RECOMMENDATIONS

As a result of the recommendations of this investigating committee, the findings of the Phillips Ad Hoc Committee, and overall management review, the following actions have been undertaken subsequent to the incident.

1. The CPP Safeguards Committee's duties and responsibilities have been enlarged to include planning and inspection relative to CPP processing activities. Procedures and equipment will be analyzed thoroughly by this committee in advance of any scheduled processing in an attempt to foresee and avoid any deficiencies which could conceivably result in criticality, loss of fissionable materials or release of radioactivity. These duties and responsibilities are outlined in Exhibit C.
2. The equipment involved in the incident has been reviewed and recommended changes have been implemented including: (a) installation of a shut-off valve in the transfer line from B cell banks to the PEW tanks, (b) installation of orifice plates in the air sparge lines to the B cell banks, and (c) installation of calibrated rotometers for measuring sparge air flow. The foregoing changes were completed before the use of B cell after the incident.
3. Radiation warning and evacuation procedures and equipment have been reviewed in light of the incident experience and the recommendations of the committees, and the following specific actions taken:
 - a. All radiation alarms in the plant have been modified to a bell signal, whereas process control alarms are by horn.
 - b. Tests have been held to assure that all personnel in the CPP have heard the evacuation and alert signals, and other tests will be scheduled at regular intervals.
 - c. Two senior shift operators and two shift health physicists have been authorized to activate the alert on the evacuation

alarm. These personnel are in addition to the shift supervisor who previously had this authority.

- d. A disconnect has been installed on the radiation lock for the stilettron at the entry to the CPP change house which will permit employees to exit through this mechanism during periods of high radiation.
- e. The addition of plant radiation alarms to the health physics field office is approximately 25 per cent complete and will continue to completion.
- f. All film badges worn by personnel at the CPP now contain inserts which will indicate neutron exposures.
- g. Neutron dosimeters have been placed in 13 strategic locations where inadvertent criticalities are determined most likely.

The foregoing actions essentially fulfill all recommendations of the committee, and these together with a continuing surveillance of the CPP Safeguards Committee are believed to materially reduce the possibility of a future criticality incident.

SECTION III - APPENDIX

TABLE I

External Exposures to Personnel in Rem from Film Badge Dosimetry

Symbol	Identification	β Exposure rem	γ Exposure rem	Total Exposure rem	β/γ ratio
A	Process Operator	44	6.0	50	7.3
B	Maintenance Man	24	8.0	32	3.0
C	Laboratory Man	6.4	3.9	10	1.6
D	Laboratory Man	4.5	1.2	5.7	3.9
E	Laboratory Man	4.2	1.2	5.4	3.6
F	Health Physicist	3.4	1.4	4.8	2.5
G	Process Operator	2.6	0.9	3.5	3.0
H	Process Operator	1.4	1.5	2.9	1
I	Laboratory Man	2.0	0.9	2.9	2.3
J	Process Operator	1.9	0.6	2.5	3.0
K	Process Operator	2.0	0.5	2.5	4.1
L	Health Physicist	1.4	0.6	2.0	2.5
M	Shift Supervisor	0.3	0.1	0.4	1.9
N	Instrument Man	0.1	0.1	0.2	2.1
O	Operator Helper	0.02	0.07	0.09	--
P	Utility Operator	0.00	0.07	0.07	--
Q	Utility Operator	0.00	0.04	0.04	--
R	Guard	0.00	0.04	0.04	--
S	Nurse	0.00	0.03	0.03	--
T	Guard	0.00	0.02	0.02	--
U	Patrol Officer	0.00	0.01	0.01	--

TABLE II

Calculated Internal Exposure to Personnel in Mrem

Identification (order of external exposure)	Sr ⁸⁹ Dose to Bone mrem	Sr ⁸⁹ Dose to GI Tract mrem	Sr ⁹¹ Dose to Bone mrem	Sr ⁹¹ Dose to GI Tract mrem	Total Bone Dose from Internal Emitters mrem	Total GI Tract Dose from Internal Emitters mrem
C	15	5.9	3.9	23	19	29
A	9	4	3.5	23	13	27
B	2	negligible	negligible	14	2	14
F	negligible	negligible	negligible	10	negligible	10
G	negligible	negligible	negligible	4.5	negligible	5

TABLE III

Activity in Blood and Urine

Identification (order of external exposure)	Gamma in Blood c/m/10 ml	Beta in Urine uc/ml x 10 ⁻⁷					Long-lived Beta Activity in Urine		
		10/16 1200	10/16 1600	10/17 0900**	10/17 1300**	10/20 1300**	Sr ⁸⁹ uc/ml x 10 ⁻⁷	Sr ⁹⁰ x 10 ⁻⁷	Ba ¹⁴⁰
A*	525 \pm 16	11,200	8,900	2,230	500	10	7.7	0.14	2.3
B***	138 \pm 13	2,720	2,340	132	146	4	2.5	0.03	1.1
C	205 \pm 14	17,000	6,300	1,380	370	17	12.0	0.19	5.0
D	42 \pm 13	290	178	104	36				
E	75 \pm 13	870	62	122	73				
F	178 \pm 14	8,300	3,150	670	310				

*gamma spectra indicated only Sr⁹¹, Y⁹¹ m and no Na²⁴

** Sr and Ba activity (chemical separation)

*** B held his breath while en route to the nearest exit.

TABLE IV

Wind and Temperature Data for Central Facilities October 16, 1959
(10 Minute Averages)

Time (MST)	Wind Direction 250 foot Degrees	Wind Speed 250 foot MPH	Wind Direction 20 foot Degrees	Wind Speed 20 foot MPH	Temperature Difference 250 - 5 foot Degrees F.
0230	009	31	000	17	0
40	360	23	009	14	0
50	348	16	015	10	1.0
0300	030	14	052	7	0.5
10	024	16	048	7	0.5
20	018	20	037	7	0.5
30	015	22	027	9	2.0
40	017	20	036	8	2.0
50	009	24	015	8	2.0
0400	012	22	024	11	2.0
10	019	25	028	11	2.0
20	021	23	038	11	2.0
30	021	20	040	9	1.0
40	030	19	051	8	1.0
50	021	20	034	13	1.0
0500	024	22	032	10	1.0
10	045	19	066	9	1.0
20	036	20	048	10	1.0
30	042	21	046	9	3.0
40	037	23	043	9	3.0
50	040	23	041	10	3.0
0600	036	23	043	11	3.0

TABLE V

Vessel Volume and Uranium Content
Data Relative to
ICPP Criticality Incident

<u>Vessel</u>	<u>Before Accidental Transfer</u>		<u>After Accidental Transfer</u>	
	<u>Vol. Liters</u>	<u>Kg Uranium</u>	<u>Vol. Liters</u>	<u>Kg Uranium</u>
B-100	252	42.3	151	25.4
B-110	<u>246</u>	<u>41.3</u>	<u>146</u>	<u>24.5</u>
	498	83.6 ± 1.5	297	49.9 ± .3

Total U that apparently moved from B cell storage into the PEW system was $83.6 \pm 1.5 - 49.9 \pm .3 = 33.7 \pm 1.5$ kg U. (See Section II and Table VII for final uranium material balance data.)

TABLE VI

Intermediate Material Balances on PEW Tanks
ICPP Criticality Incident

Material to be Accounted for = 33.7 ± 1.5 kg U

Balance Immediately After Nuclear Incident

<u>Vessel</u>	<u>Vol. (Liters)</u>	<u>Kg U</u>
WH-100	76	$25.8^* \pm 1.5$
WG-101	14,504	$7.9 \pm .3$

Balance After Transfer of all Solution From WH-100 to WG-101

<u>Vessel</u>	<u>Vol. (Liters)</u>	<u>Kg U</u>
WH-100	50	$19.1^* \pm 1.6$
WG-101	15,500**	$14.6 \pm .5$

Balance After Poisoning WH-100 & Transferring All Solution From WG-101 to WH-100

<u>Vessel</u>	<u>Vol. (Liters)</u>	<u>Kg U</u>
WH-100	14,700	24.6 ± 1.0
WG-101	37	nil
D Cell	3,300	$3.1 \pm .2$
CFD		$.5 \pm .2$
		28.2 ± 1.0

Apparent Imbalance $5.5^{***} \pm 1.8$ kg U

*This is a by-difference estimate. Subsequent data indicate only a fraction of this total was in solution.

**Includes 3,300 liters transferred to D cell.

***Subsequent cleanout data indicated a major portion of this was in the system piping and/or still on the walls of WH-100.

TABLE VII

Final Material Balance
ICPP Criticality Incident

<u>Description</u>	<u>Material to be Accounted for (Kg U)</u>	<u>Material Accounted for (Kg U)</u>
Total Material Dissolved	88.6 ± .5	
Material to Process From Other Sources	8.9 ± .3	
Waste		2.2 ± .1
Reference Samples		.3 ± .0
Product		91.8 ± .2
Recycle Material		.2 ± .1
Inventory of Product Storage Banks		2.2 ± .2
	<hr/>	<hr/>
	97.5 ± .6	96.7 ± .3
Imbalance		.8 ± .7

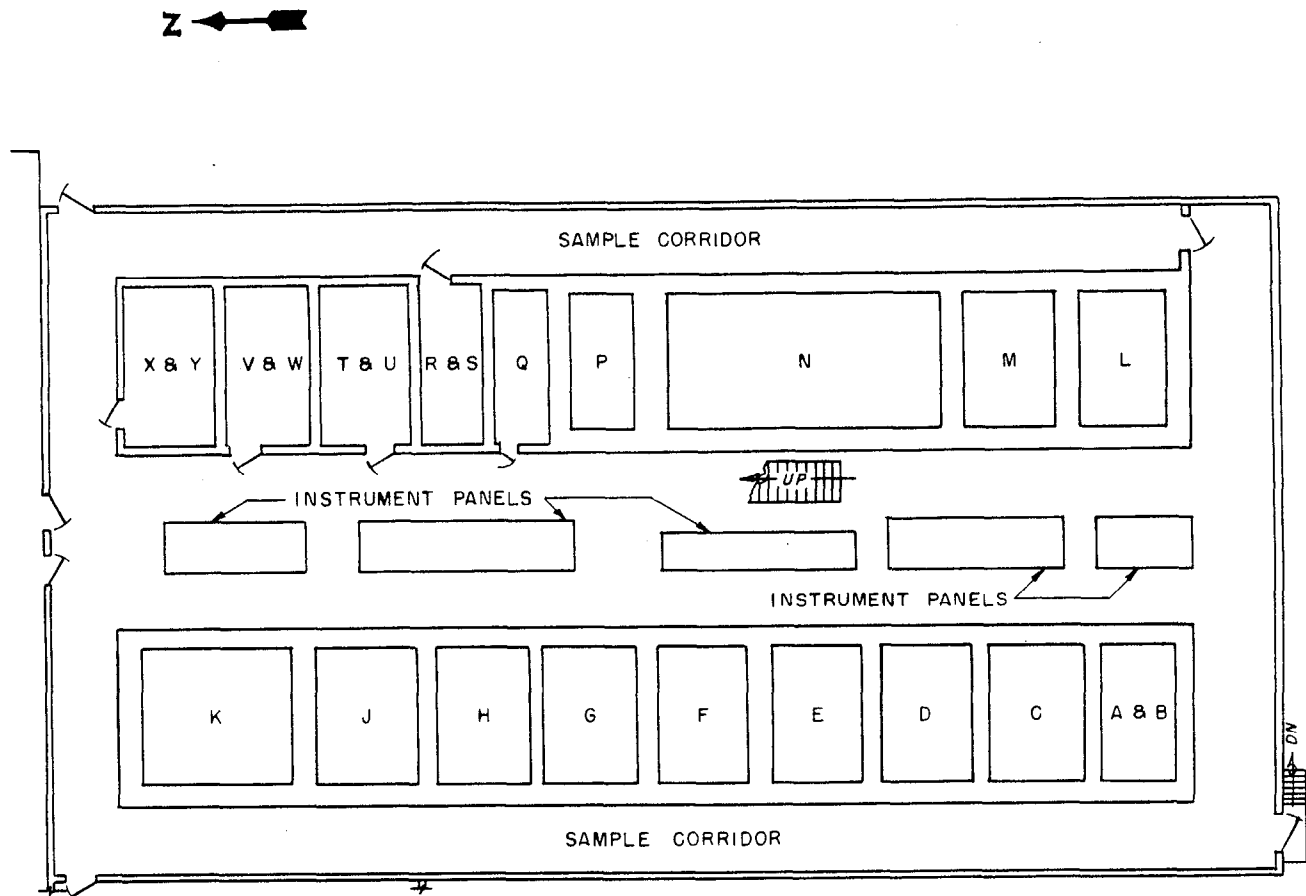

CELL DESCRIPTION

- | | | | |
|---|---------------------------|-------|---|
| A | EBR DISSOLUTION | M | SPARE |
| B | UNH FEED STORAGE | N | FEED STORAGE |
| C | BATCH AI DISSOLUTION | P | 1 st CYCLE EXTRACTION |
| D | BATCH AI DISSOLUTION | Q | 2 nd CYCLE EXTRACTION |
| E | SS - Zr DISSOLUTION | R & S | 3 rd CYCLE EXTRACTION |
| F | SS - Zr TBP EXTRACTION | T | SOLVENT FEED |
| G | CONTINUOUS AI DISSOLUTION | U | 1 st CYCLE AQUEOUS RAFFINATE |
| H | AI TBP EXTRACTION | V | H P OFFICE |
| J | SALVAGE | W | 1 st CYCLE ORGANIC RAFFINATE |
| K | SOLVENT RECOVERY | X | SAMPLE DILUTION |
| L | RALA | Y | 2 nd , 3 rd CYCLE RAFFINATE |

Fig. 1
PROCESS BUILDING ARRANGEMENT

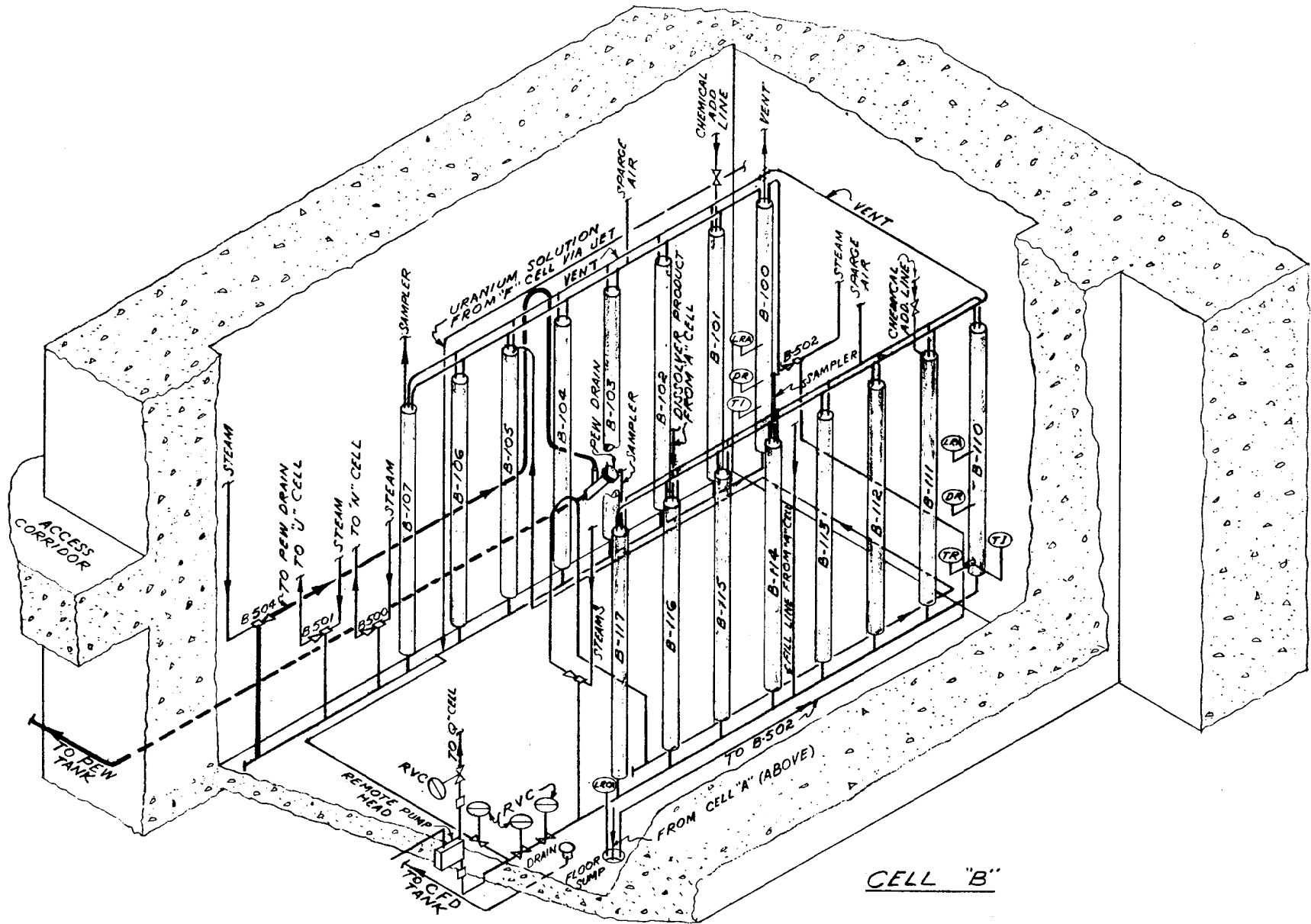

Fig. 2
CELL "B"

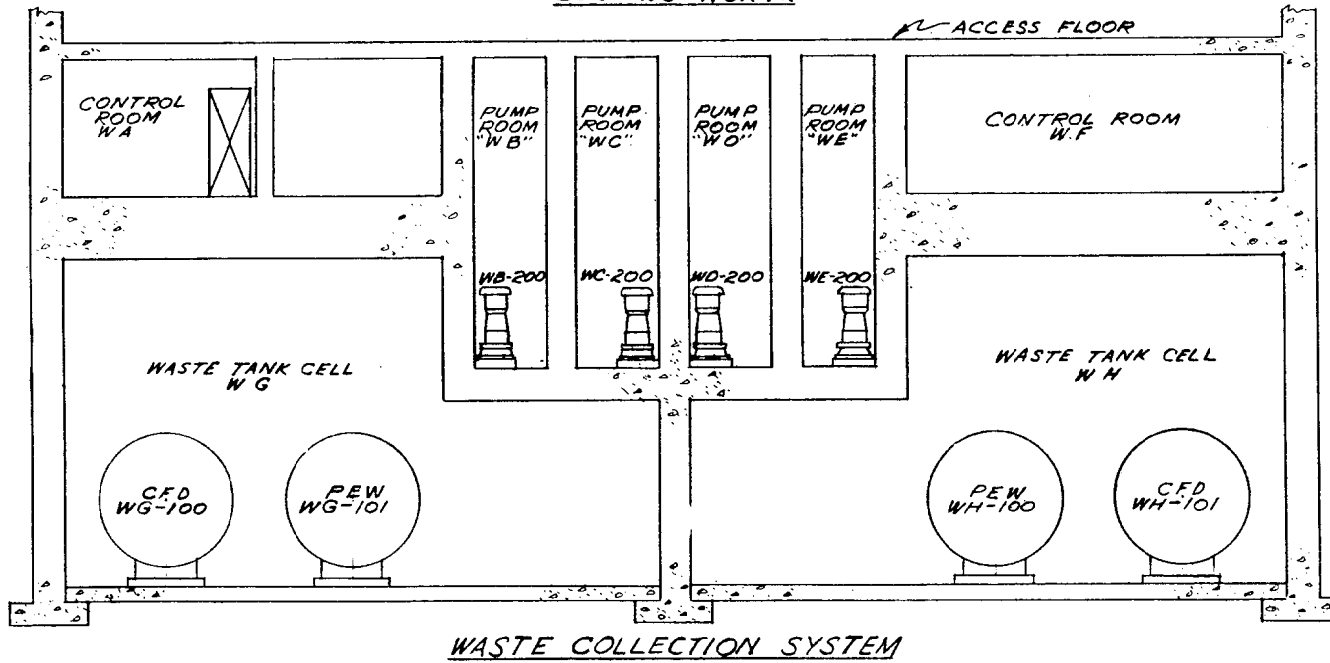
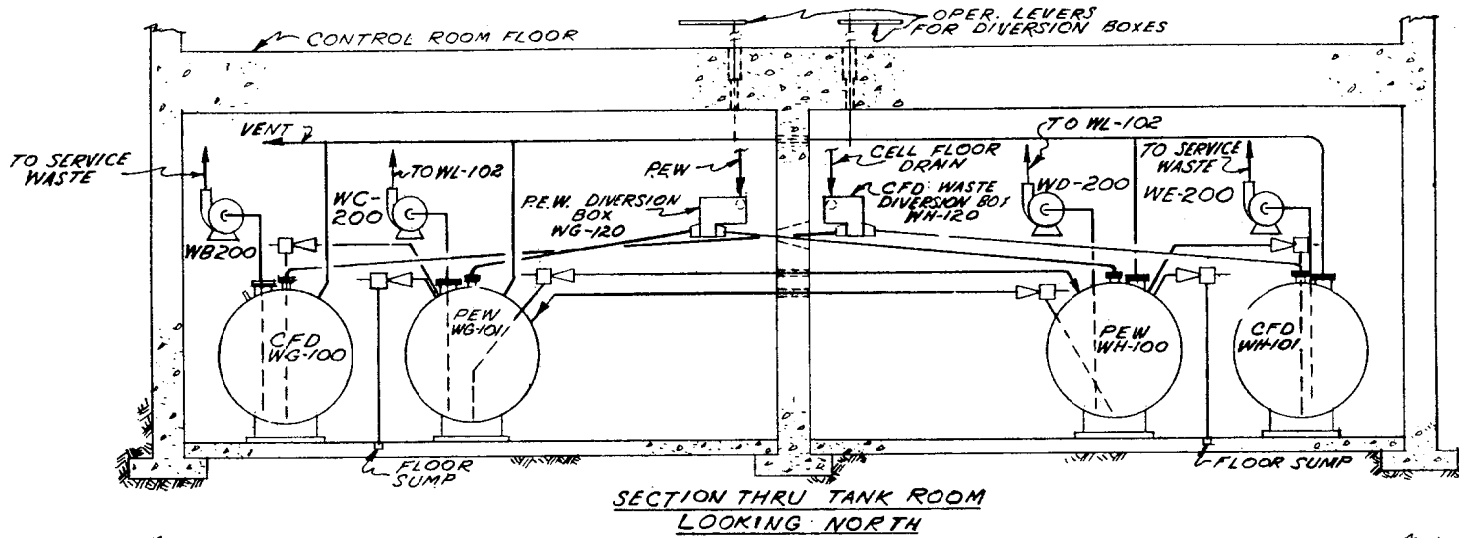

Fig. 3
WASTE COLLECTION SYSTEM

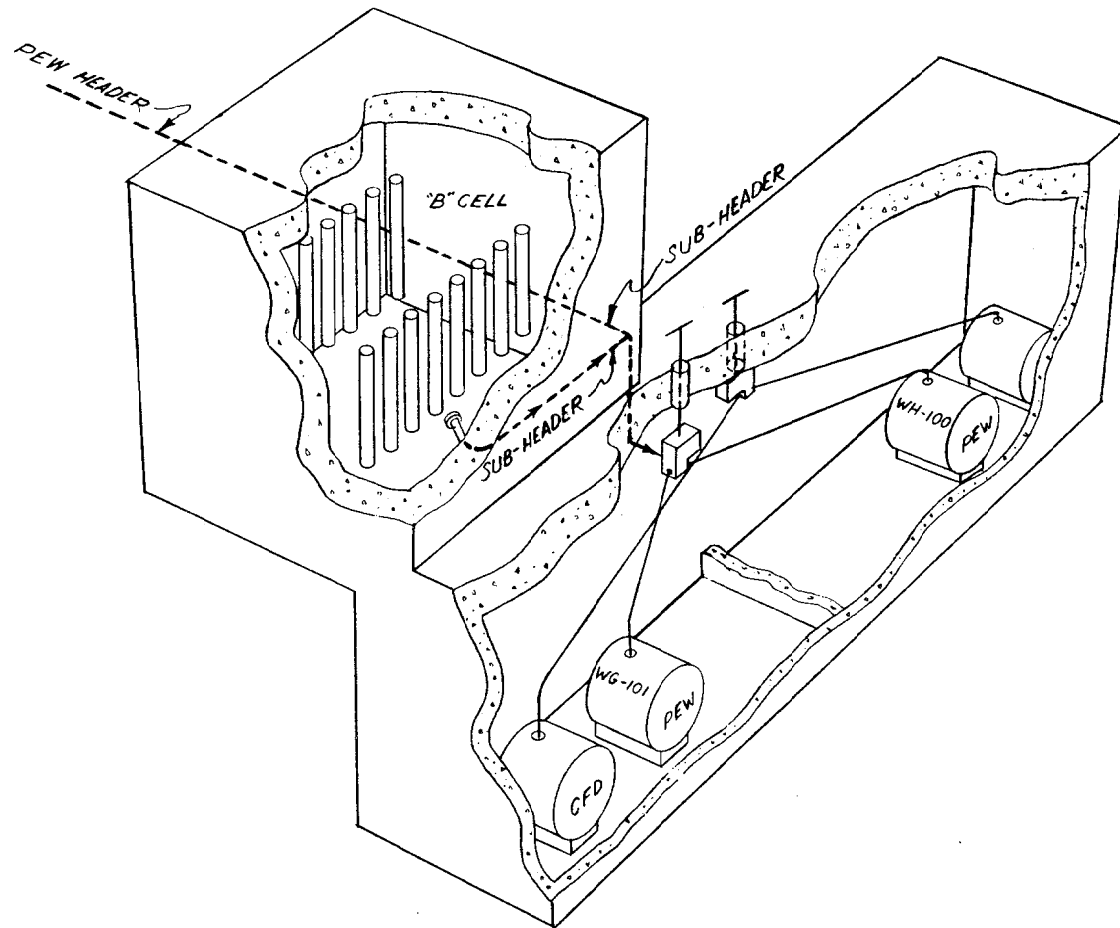
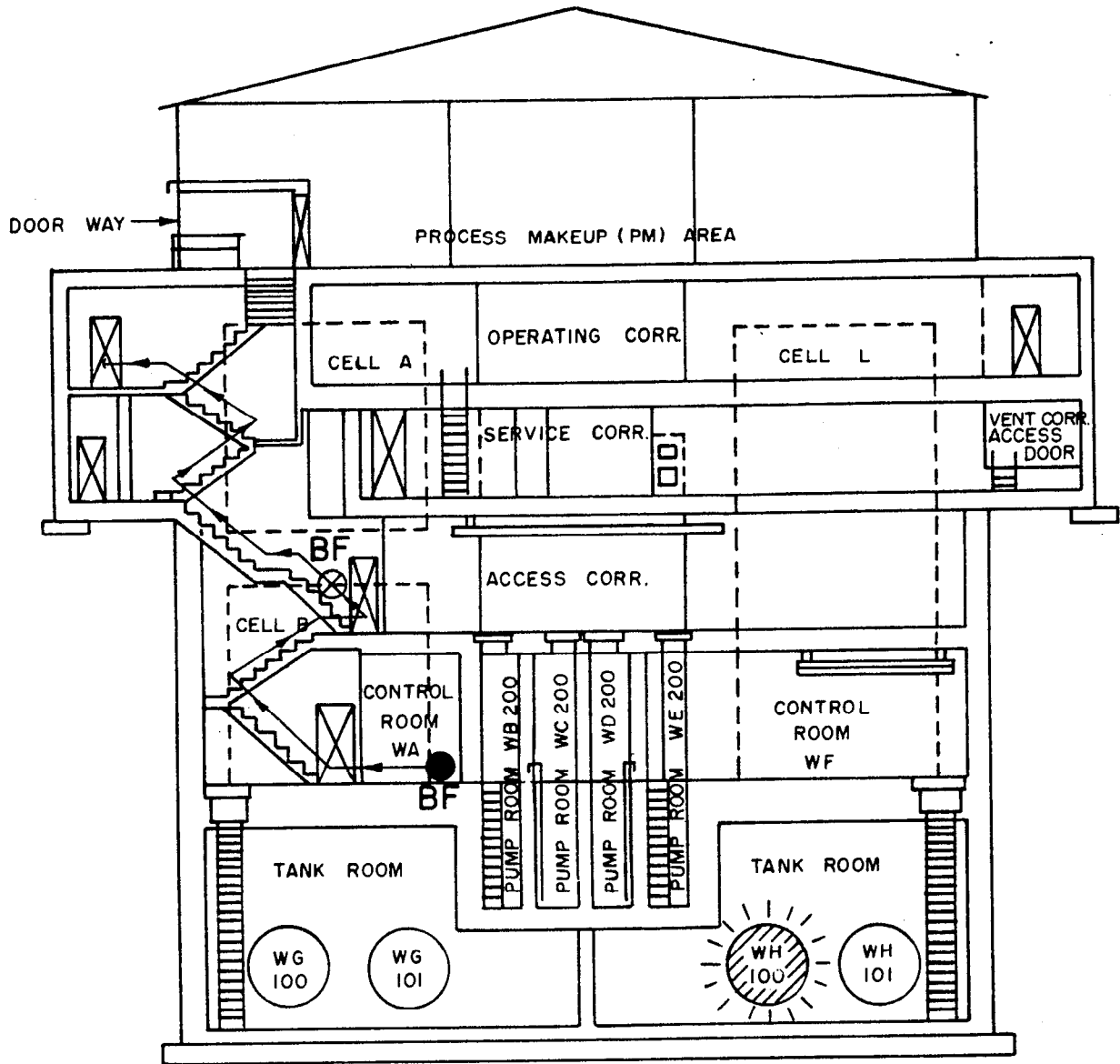
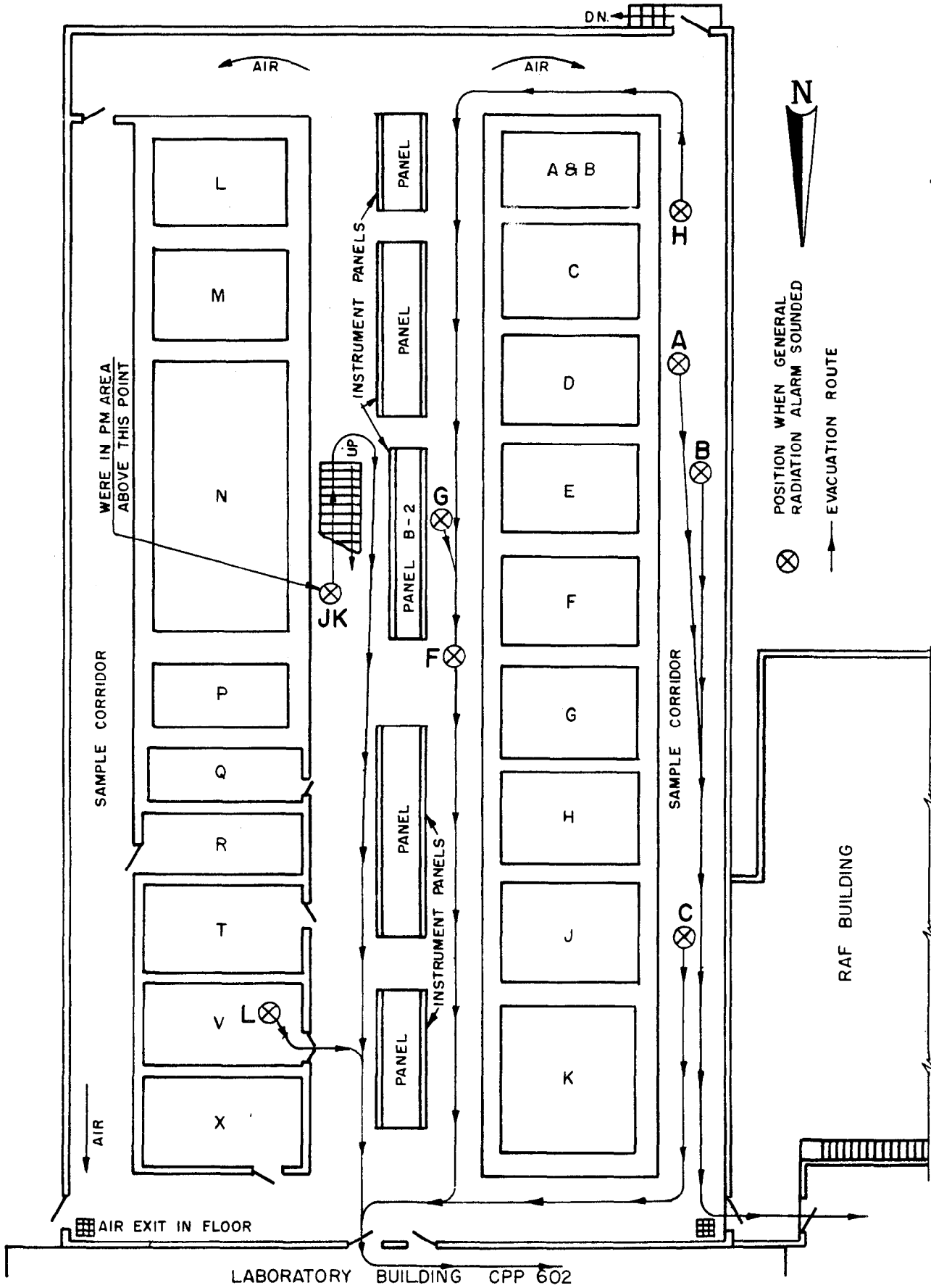

Fig. 4
RELATIVE CELL LOCATION



- ⊗ LOCATION AT FIRST LOCAL RADIATION ALARM - L CELL CAM
- PRIOR LOCATION
- EVACUATION ROUTE

Fig. 5
CROSS SECTION OF PROCESS BLDG. CPP 601
LOOKING NORTH FROM WASTE TANK ROOM



LABORATORY BUILDING CPP 602

Fig. 6
PLAN VIEW-OPERATING AREA PROCESS BLDG. CPP 601

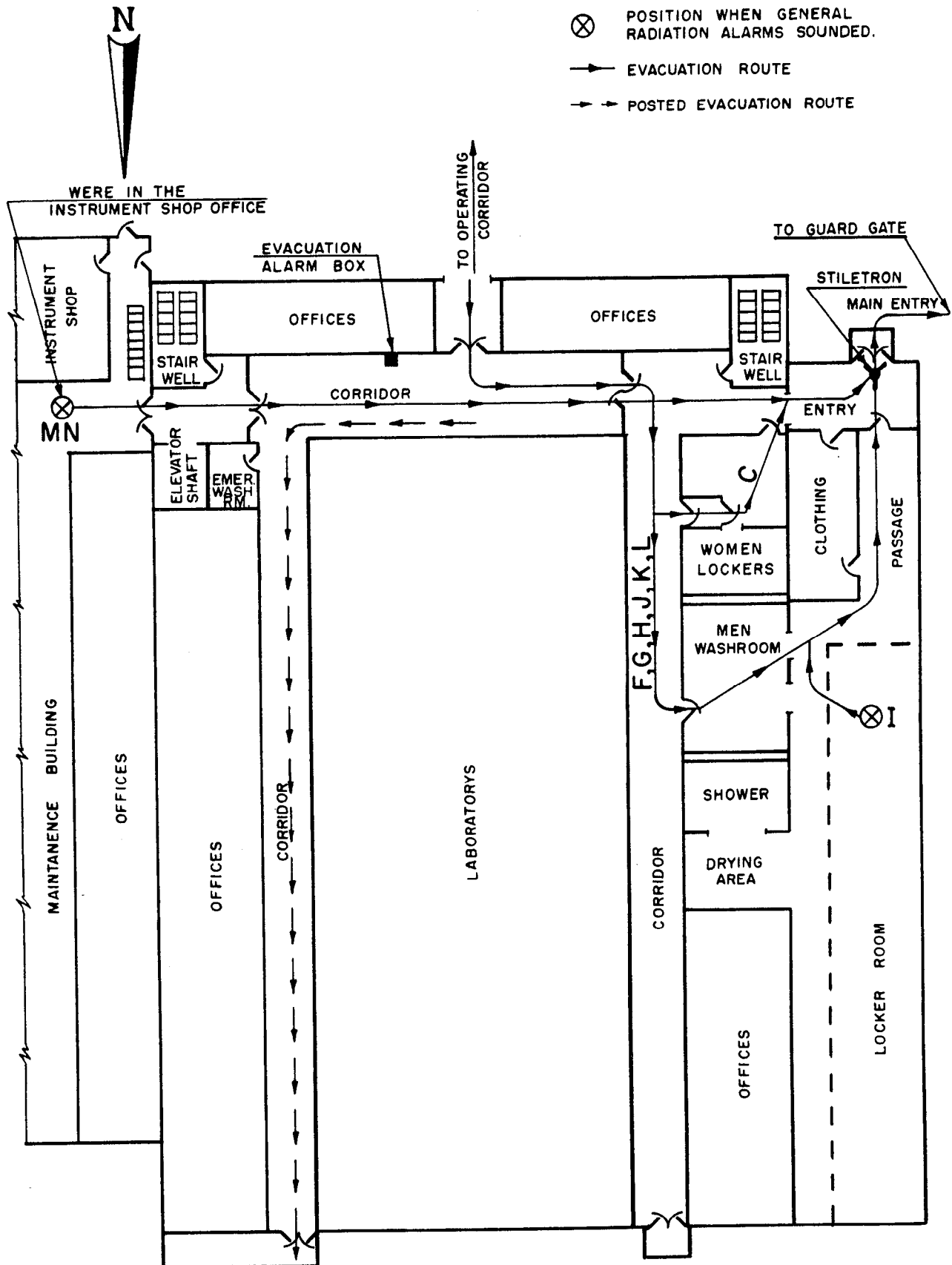

Fig. 7
 FIRST FLOOR PLAN LABORATORY BLDG. CPP 602

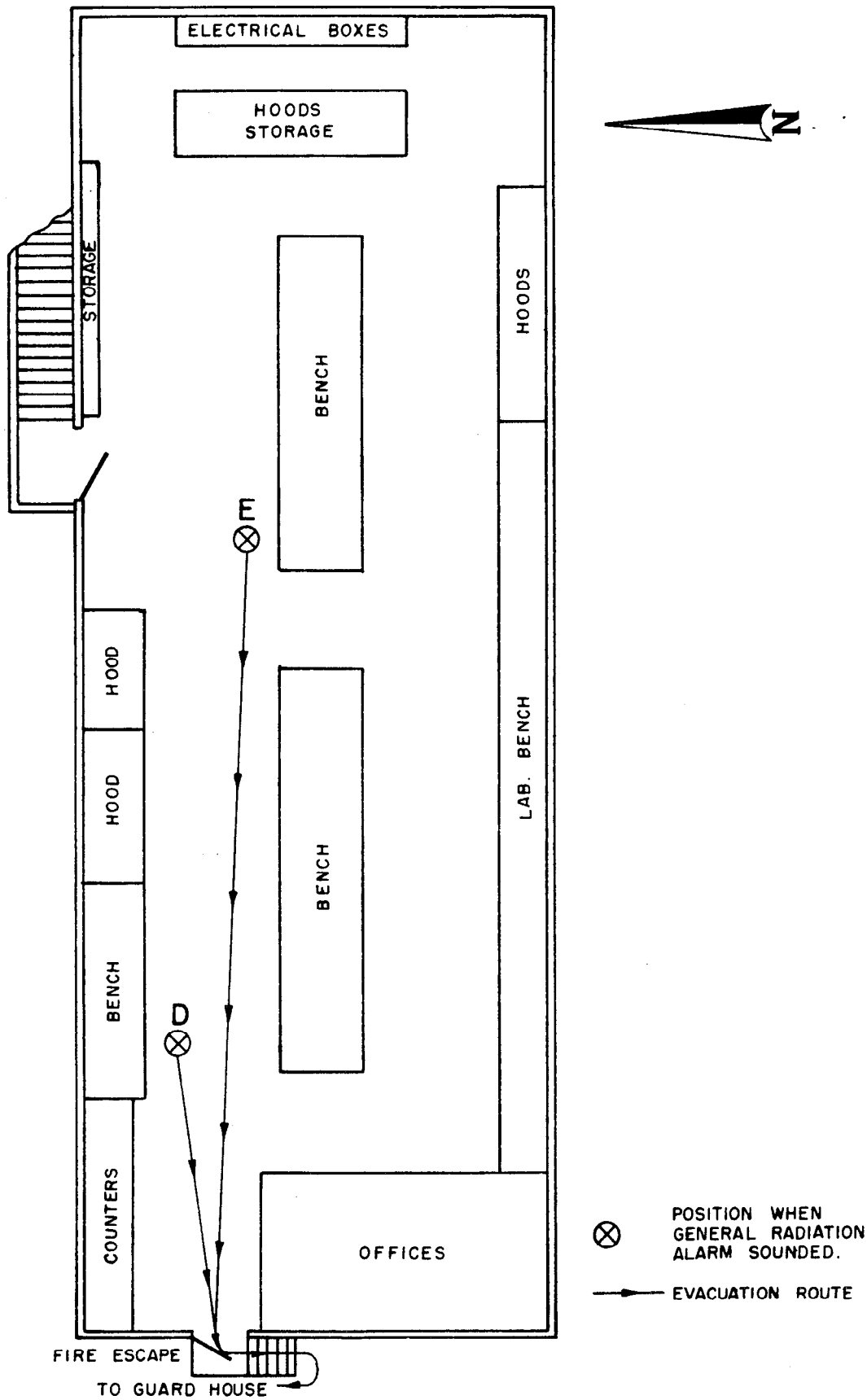

Fig. 8
 SECOND FLOOR PLAN
 SHIFT CONTROL LAB. ROOM-RAF BUILDING CPP 627

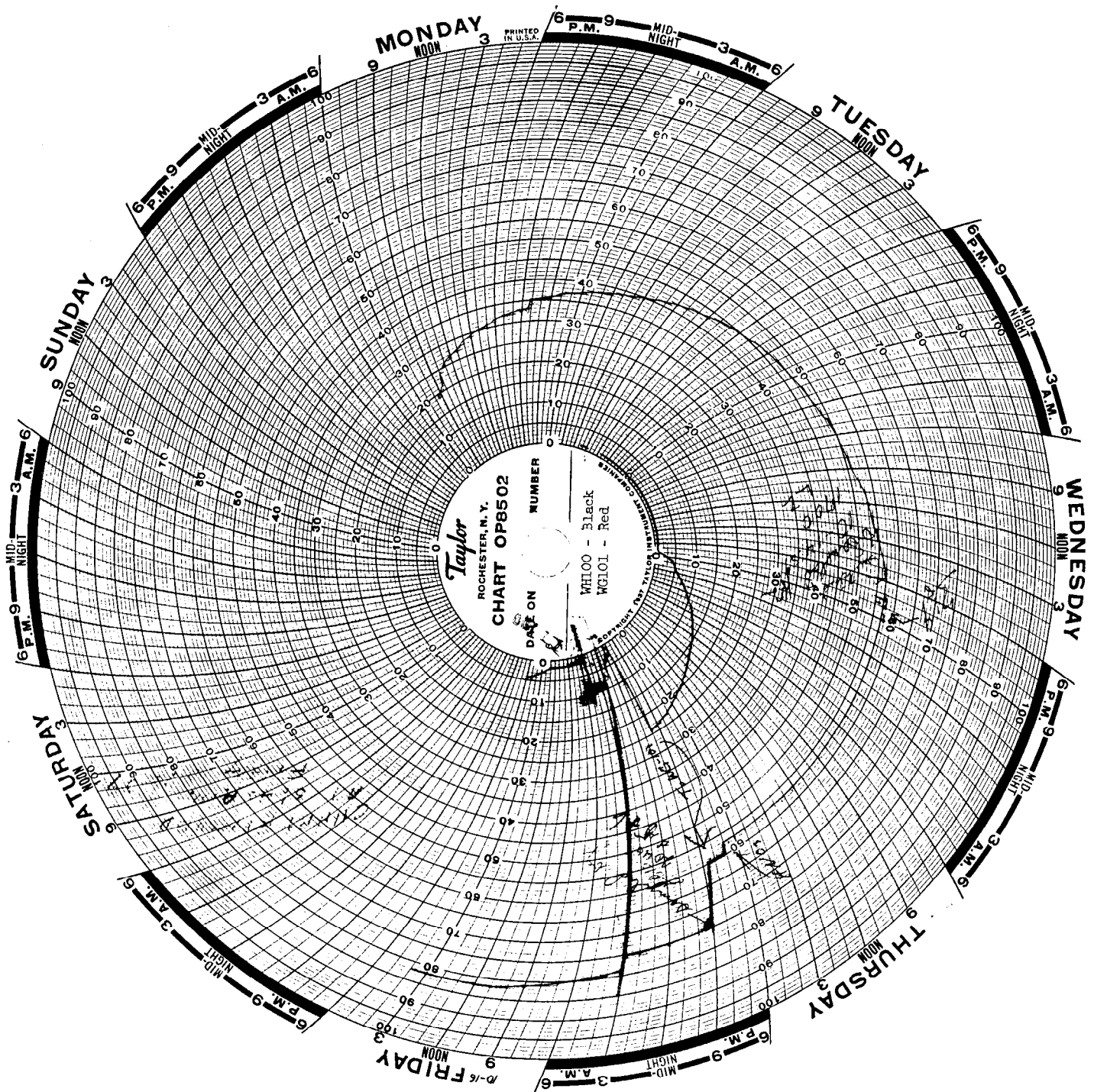

Figure 9
 PEW INSTRUMENT CHART
 0800 October 12 to 1600 October 16

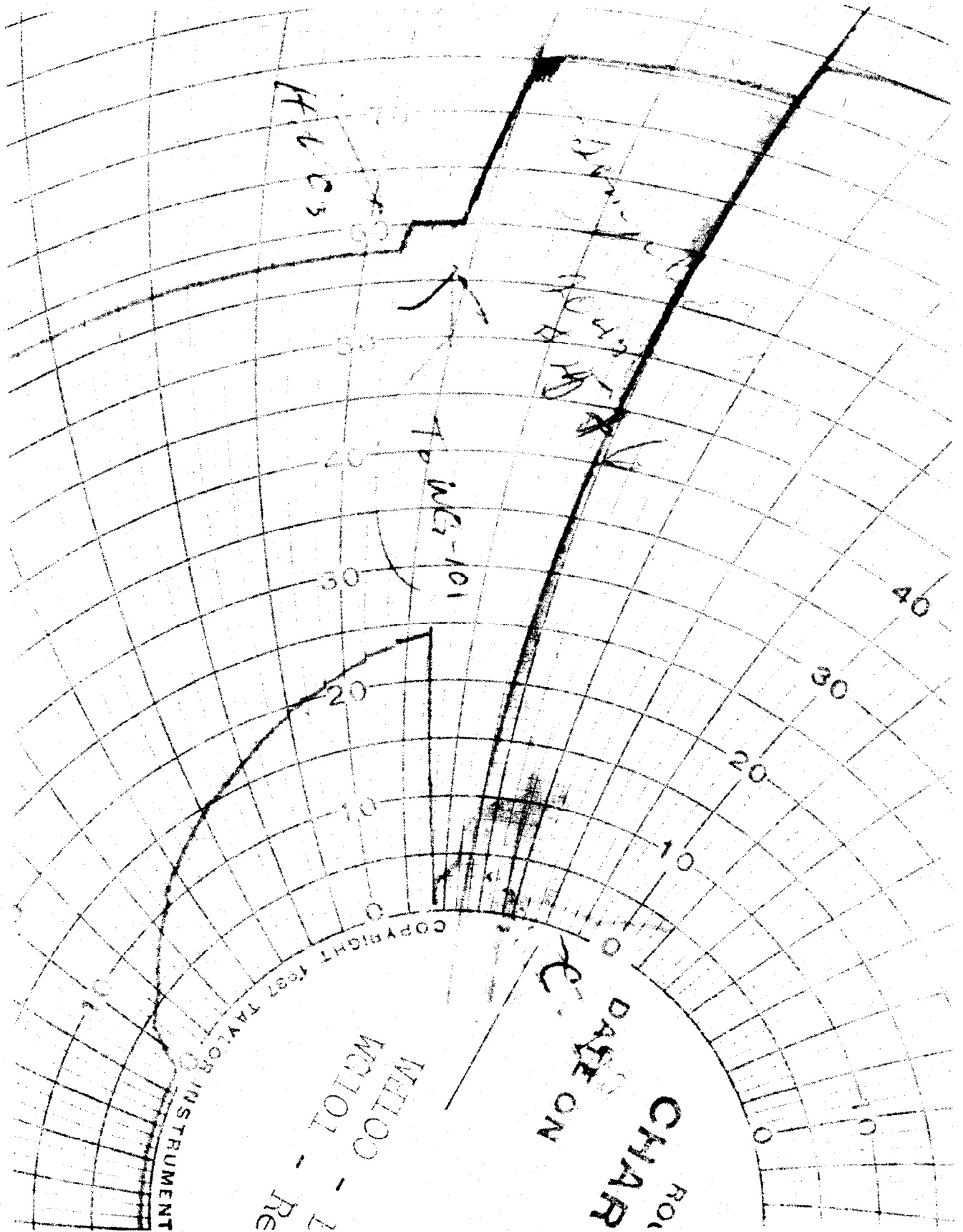
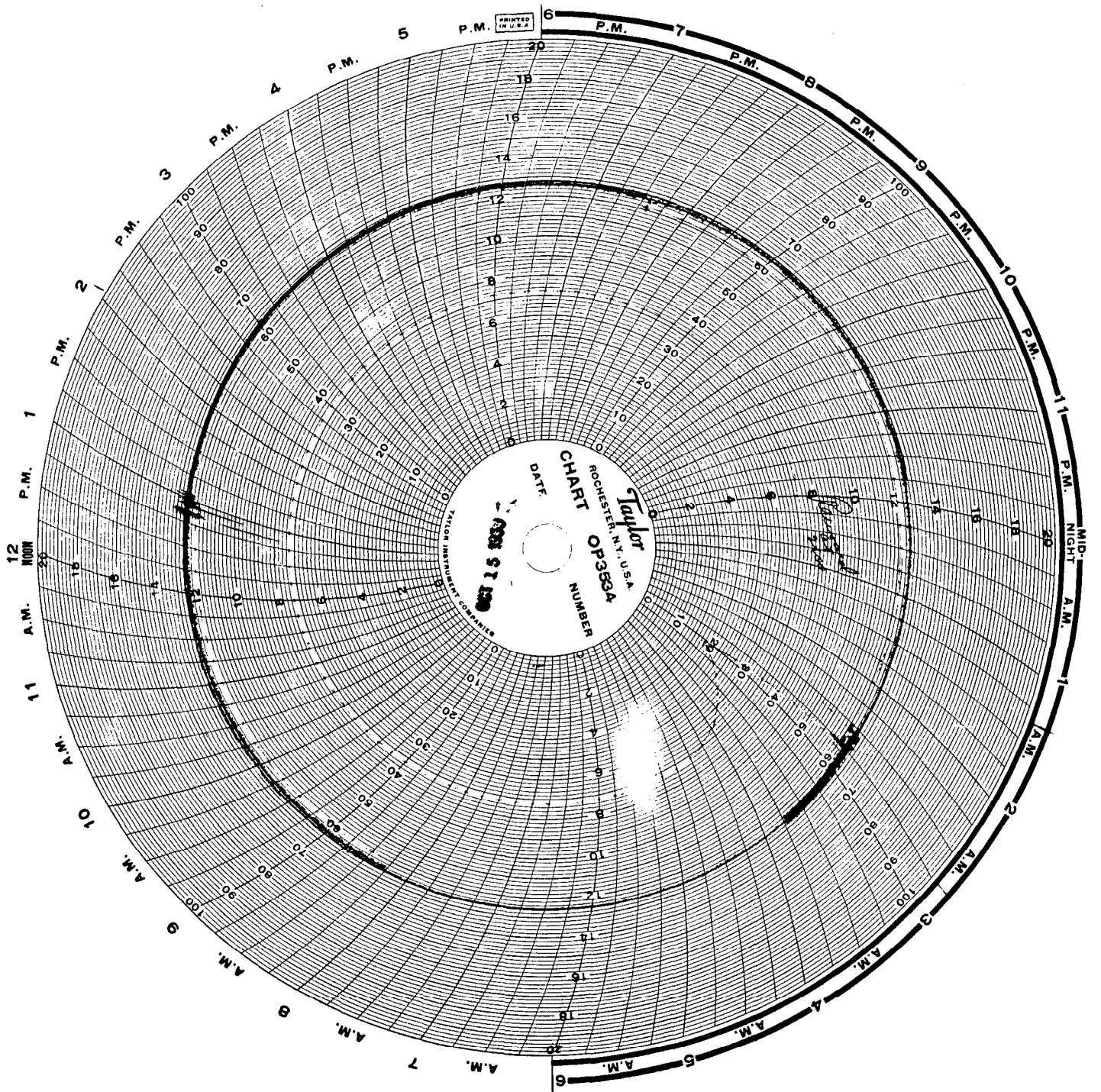
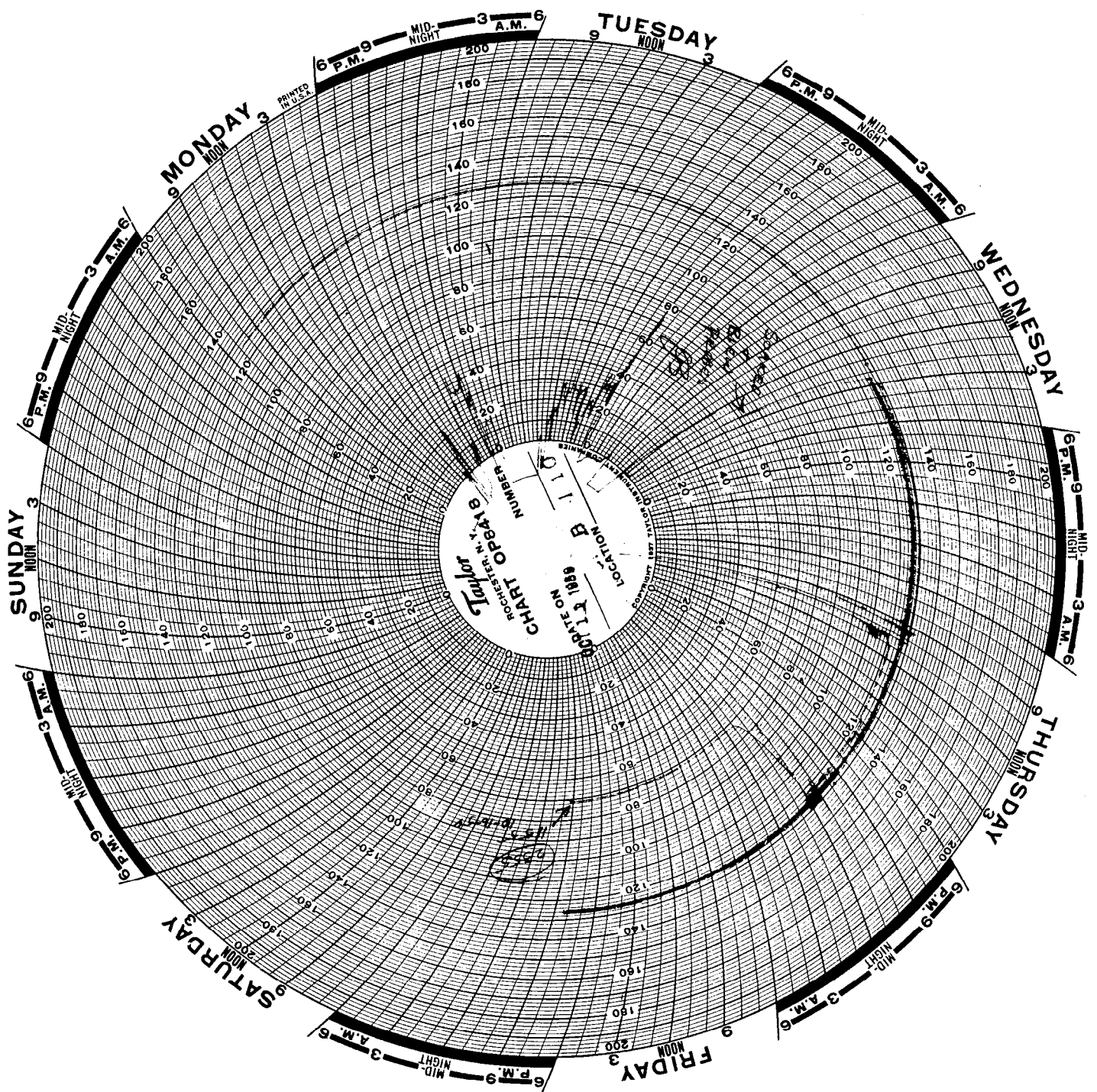

Figure 9A
 Enlargement of Portion
 of
 PEW Instrument Chart



B 100 INSTRUMENT CHART
 0800 October 15 to 2400 October 16
 Liquid Level - Blue, Specific Gravity - Red
 Figure 10



B 110 INSTRUMENT CHART
 0800 October 12 to 2400 October 16
 Liquid Level - Blue, Specific Gravity - Red
 Figure 11

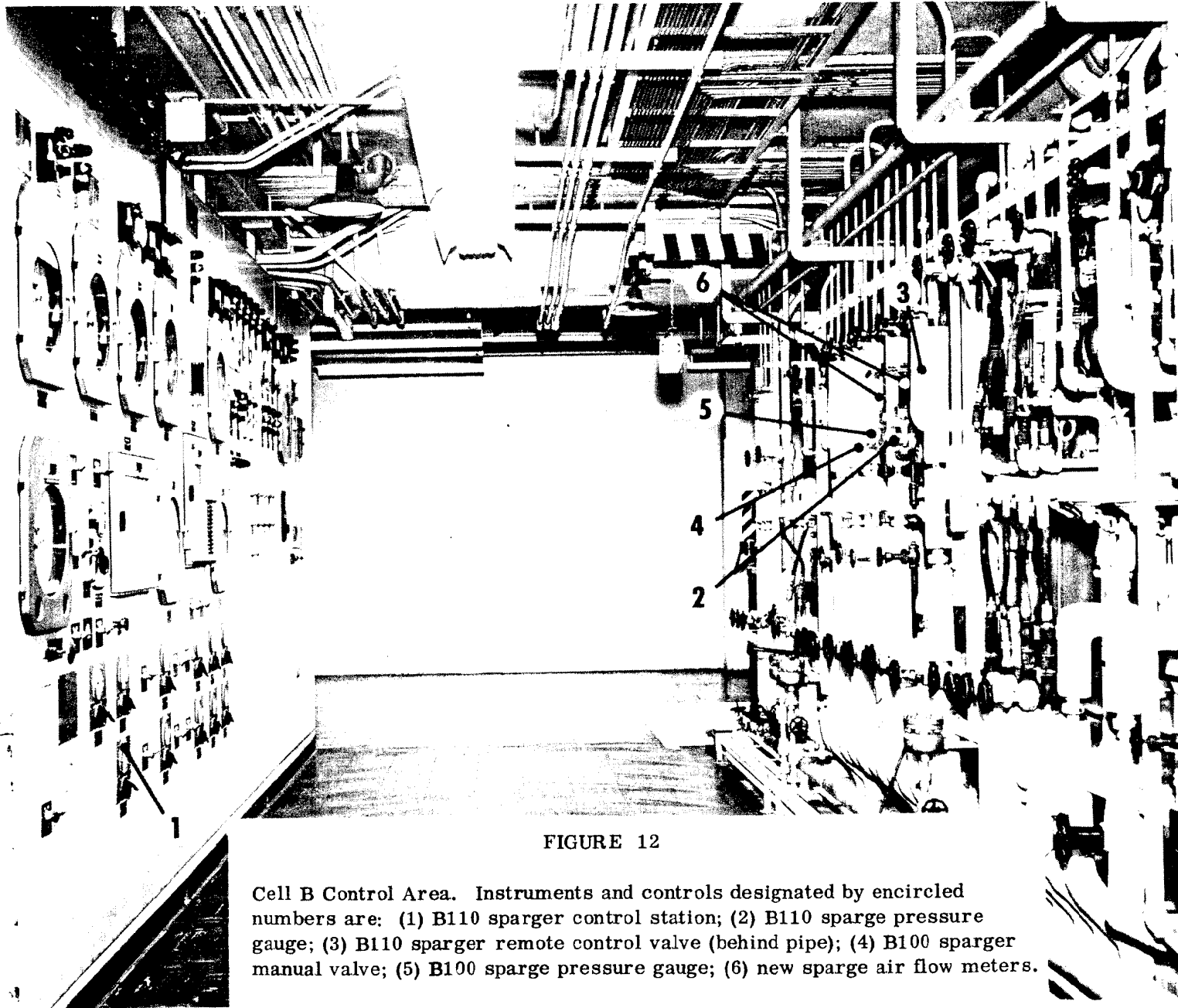

FIGURE 12

Cell B Control Area. Instruments and controls designated by encircled numbers are: (1) B110 sparger control station; (2) B110 sparge pressure gauge; (3) B110 sparger remote control valve (behind pipe); (4) B100 sparger manual valve; (5) B100 sparge pressure gauge; (6) new sparge air flow meters.

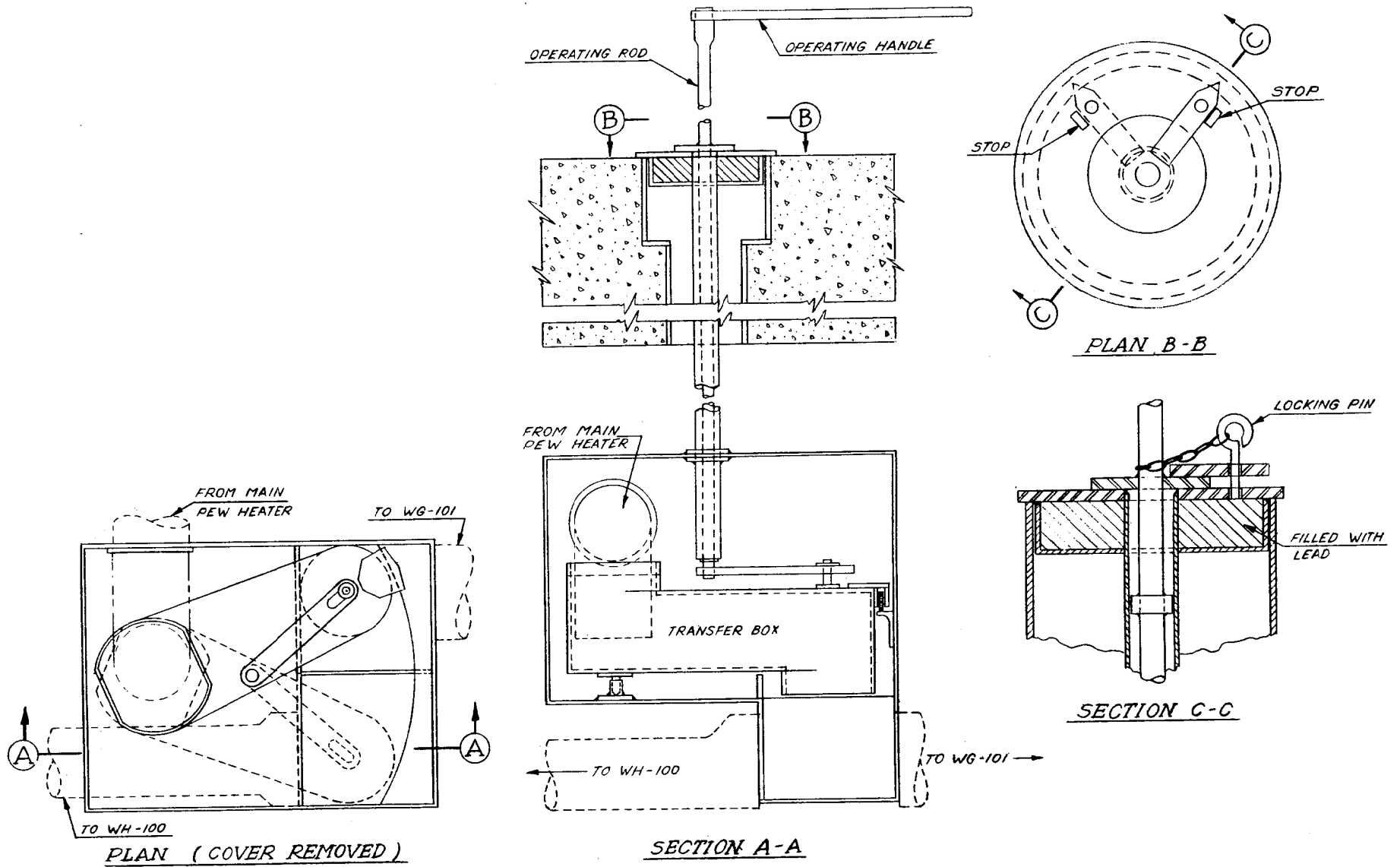

Fig. 13
PEW DIVERSION BOX

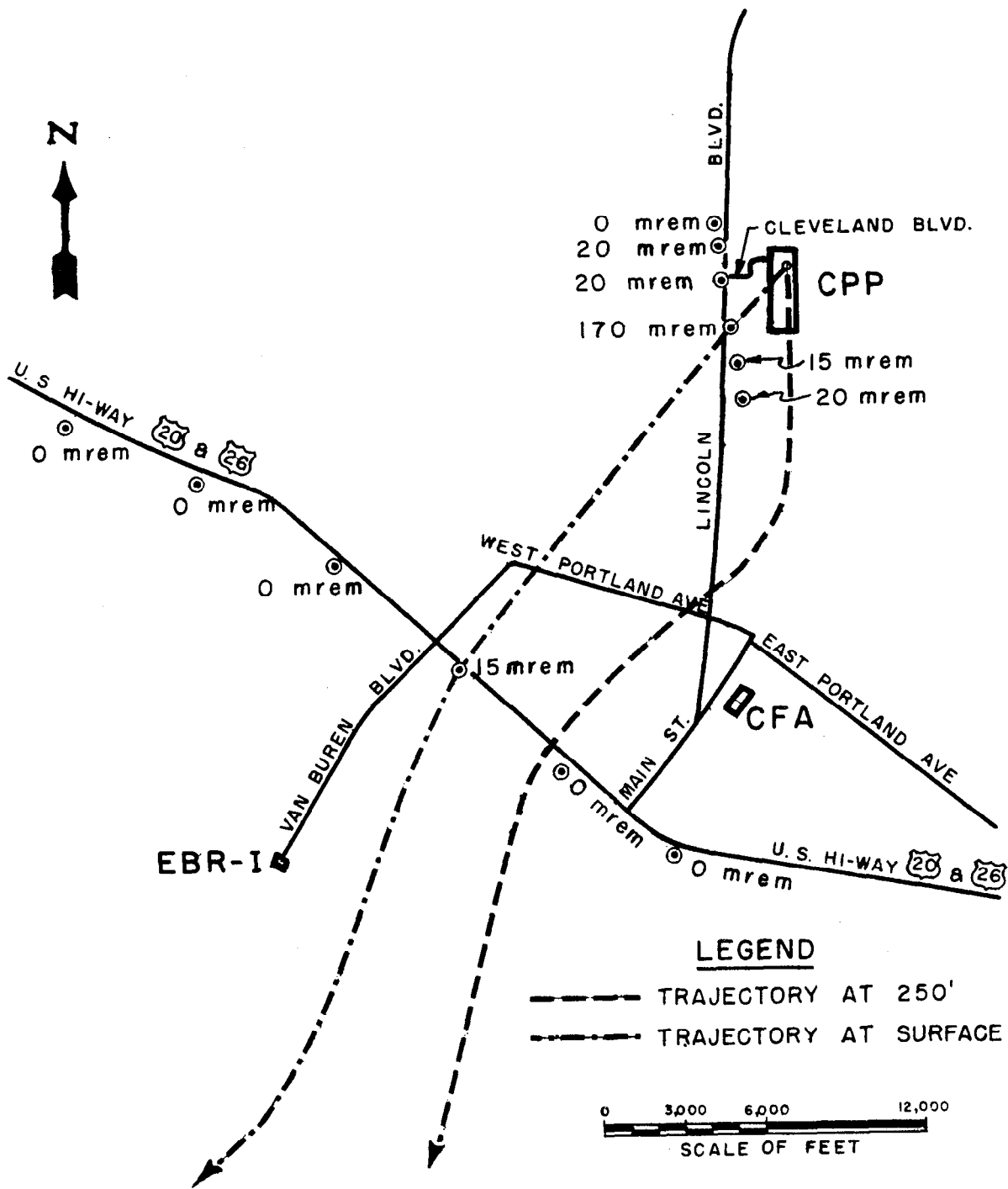

Fig. 15
 CPP INCIDENT OF OCTOBER 16, 1959
 ESTIMATED CLOUD TRAJECTORIES
 & FILM BADGE DATA

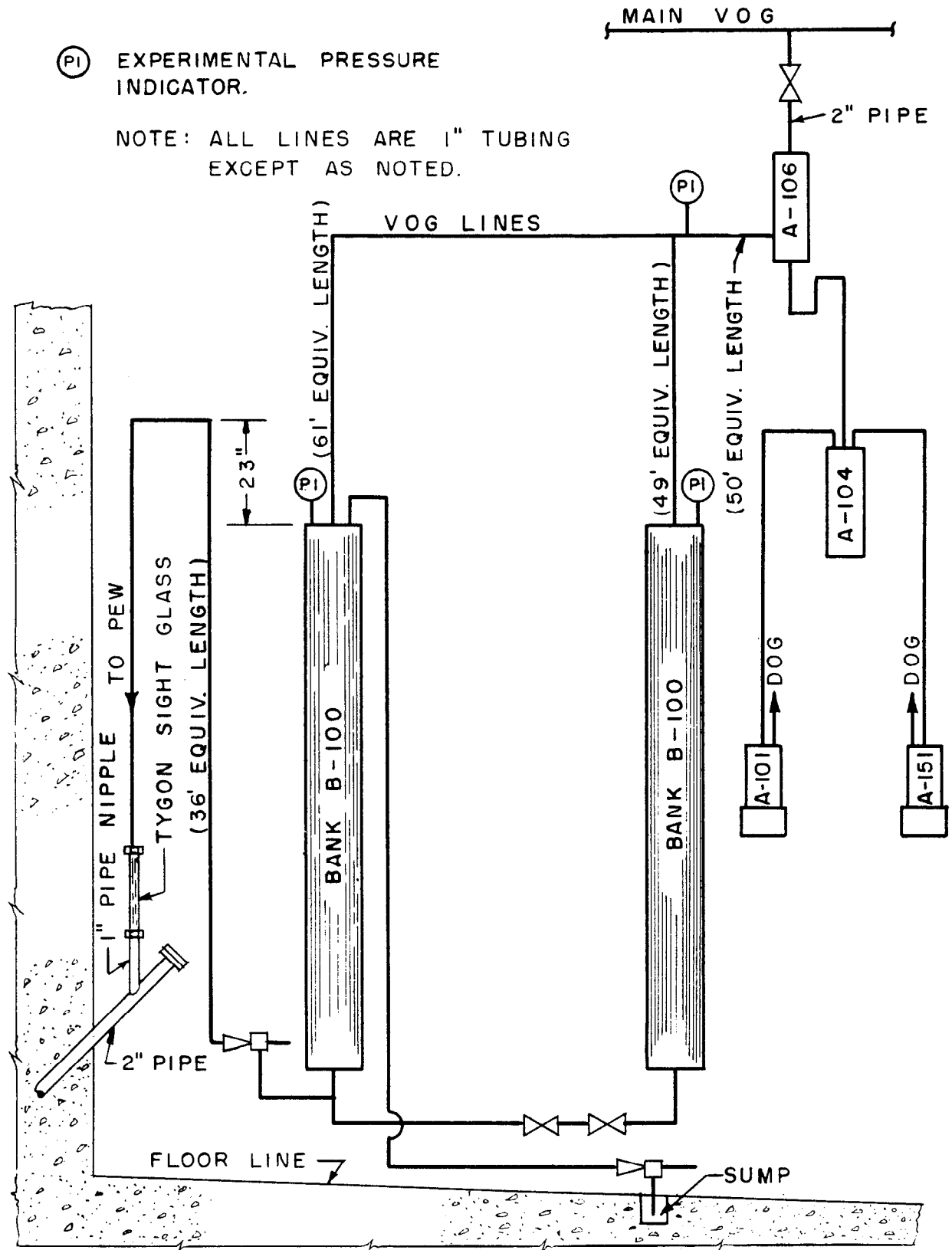

Fig. 16
 SCHEMATIC DIAGRAM OF
 "A" & "B" CELLS EQUIPMENT

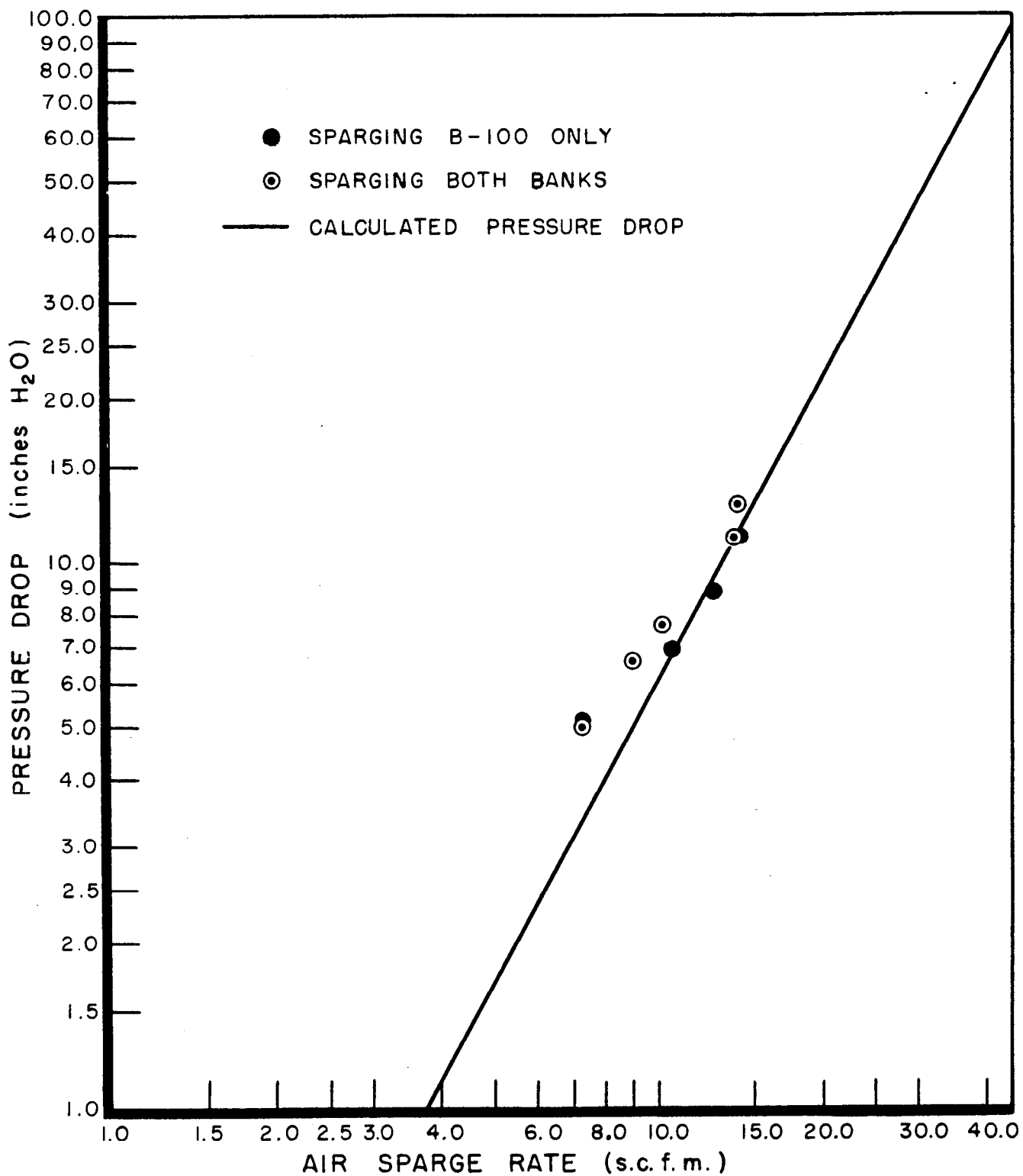

Fig. 17
 COMPARISON OF CALCULATED AND MEASURED
 PRESSURE DROPS FOR BANK B-100 VOG LINE
 (1" Dia. x 61' Long S. S. Tubing)

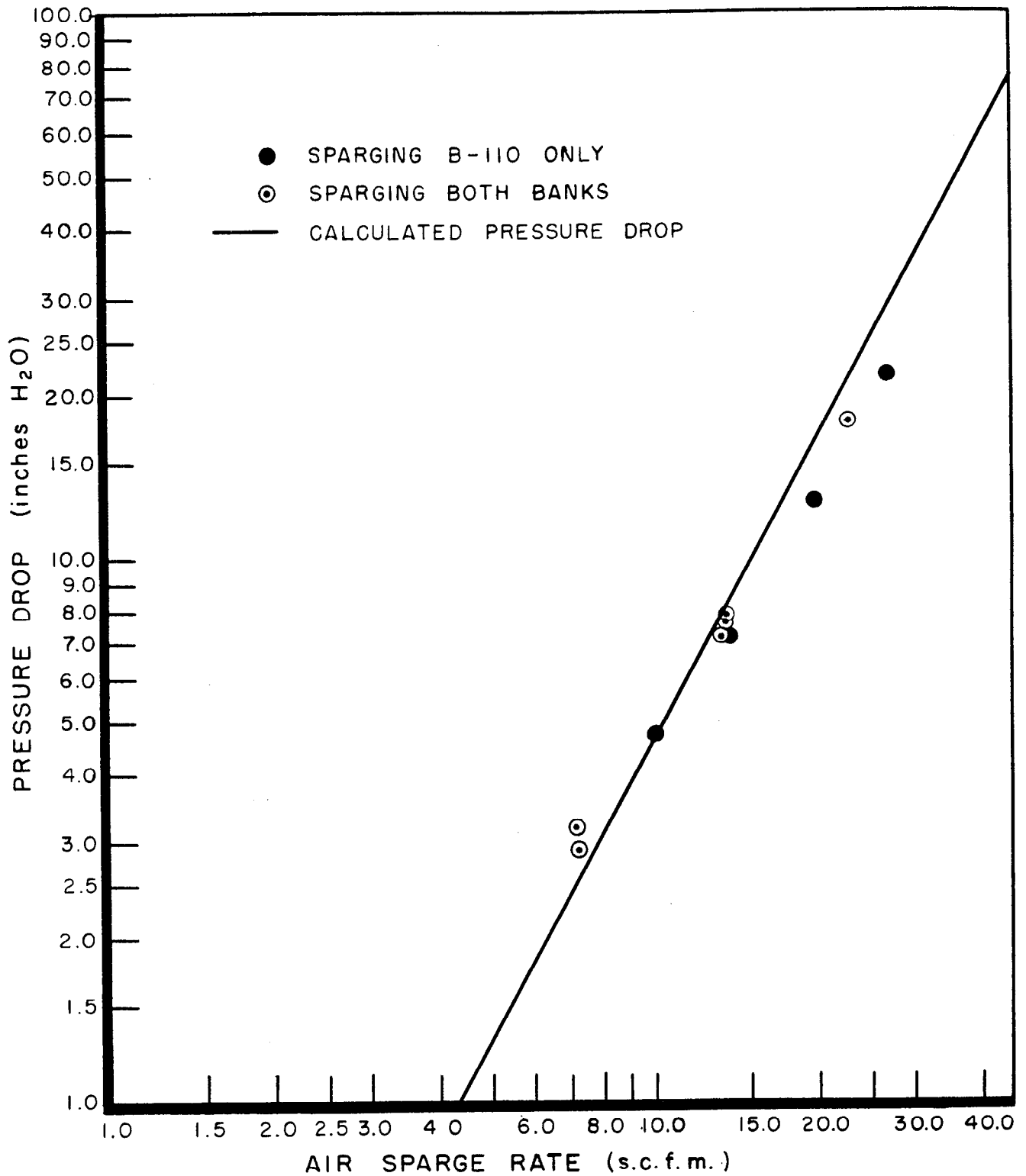

Fig. 18
 MEASURED PRESSURE DROPS
 FOR BANK B-110 VOG LINE
 (1" Dia. x 49' Long S. S. Tubing)

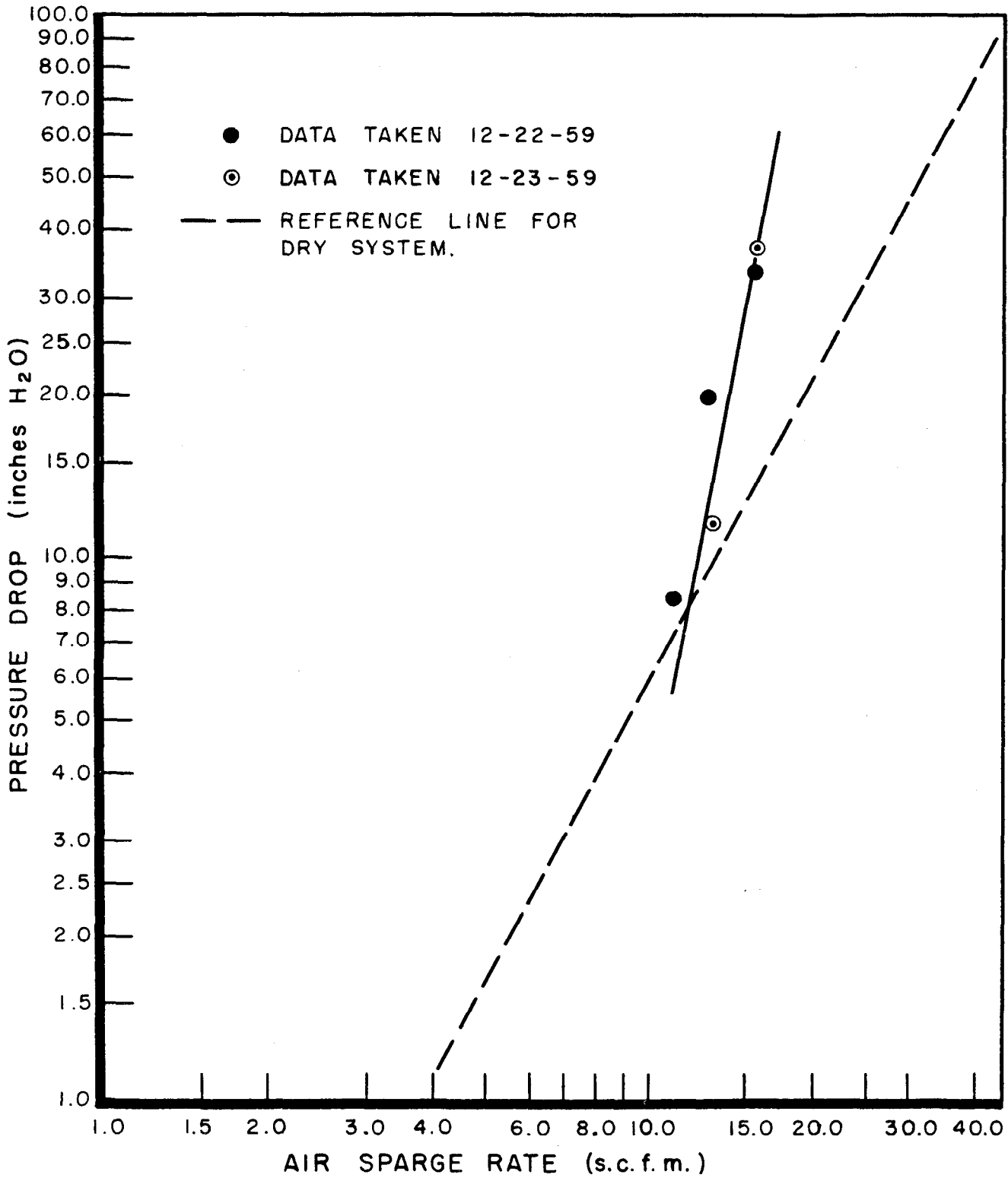

Fig. 19
 EFFECT OF LIQUID ON PRESSURE DROPS
 FOR BANK B-100 VOG LINE
 (1" Dia. x 61' Long S. S. Tubing)

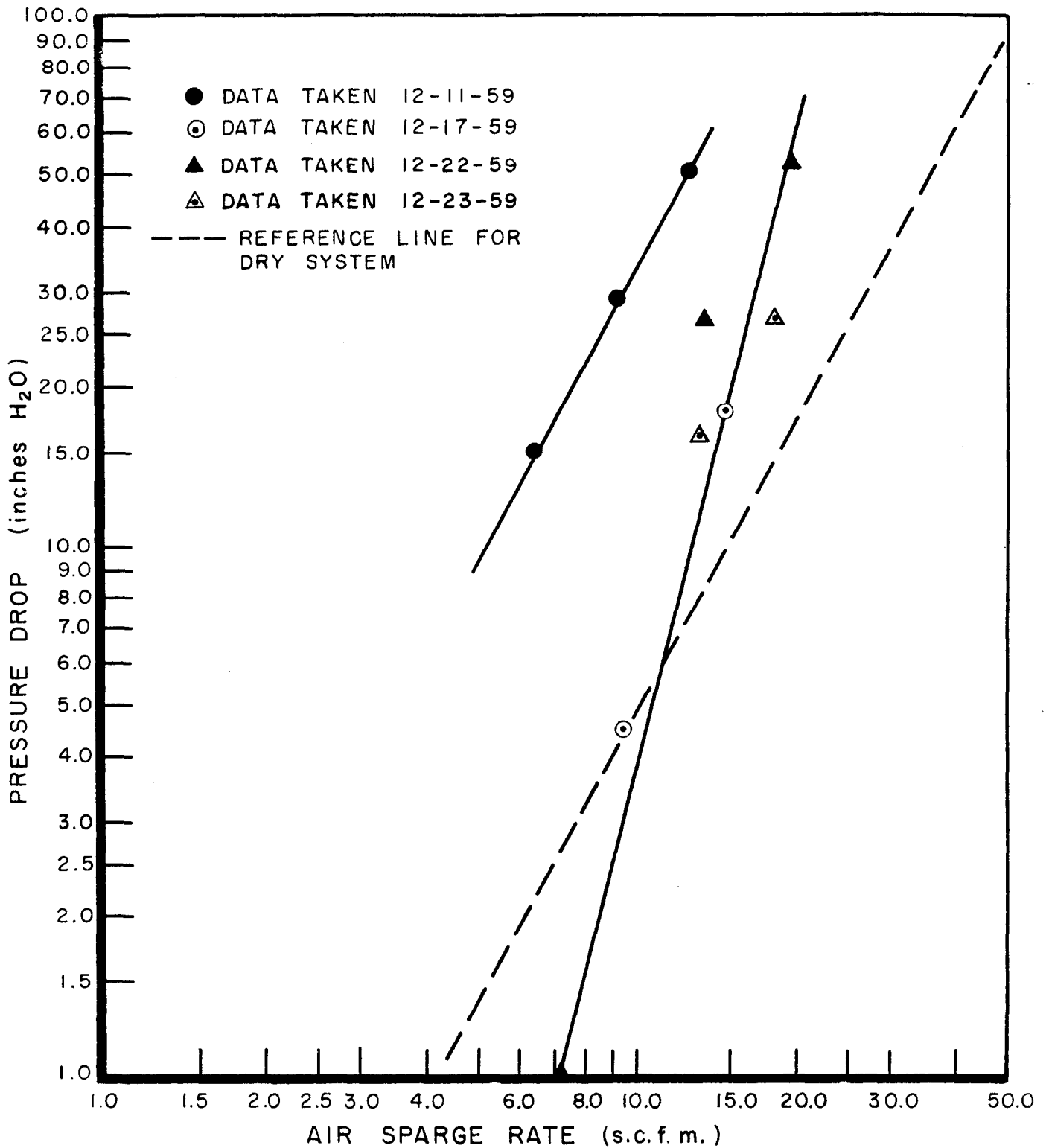

Fig. 20
 EFFECT OF LIQUID ON PRESSURE DROPS
 FOR BANK B-110 VOG LINE
 (1" Dia. x 49' Long S. S. Tubing)

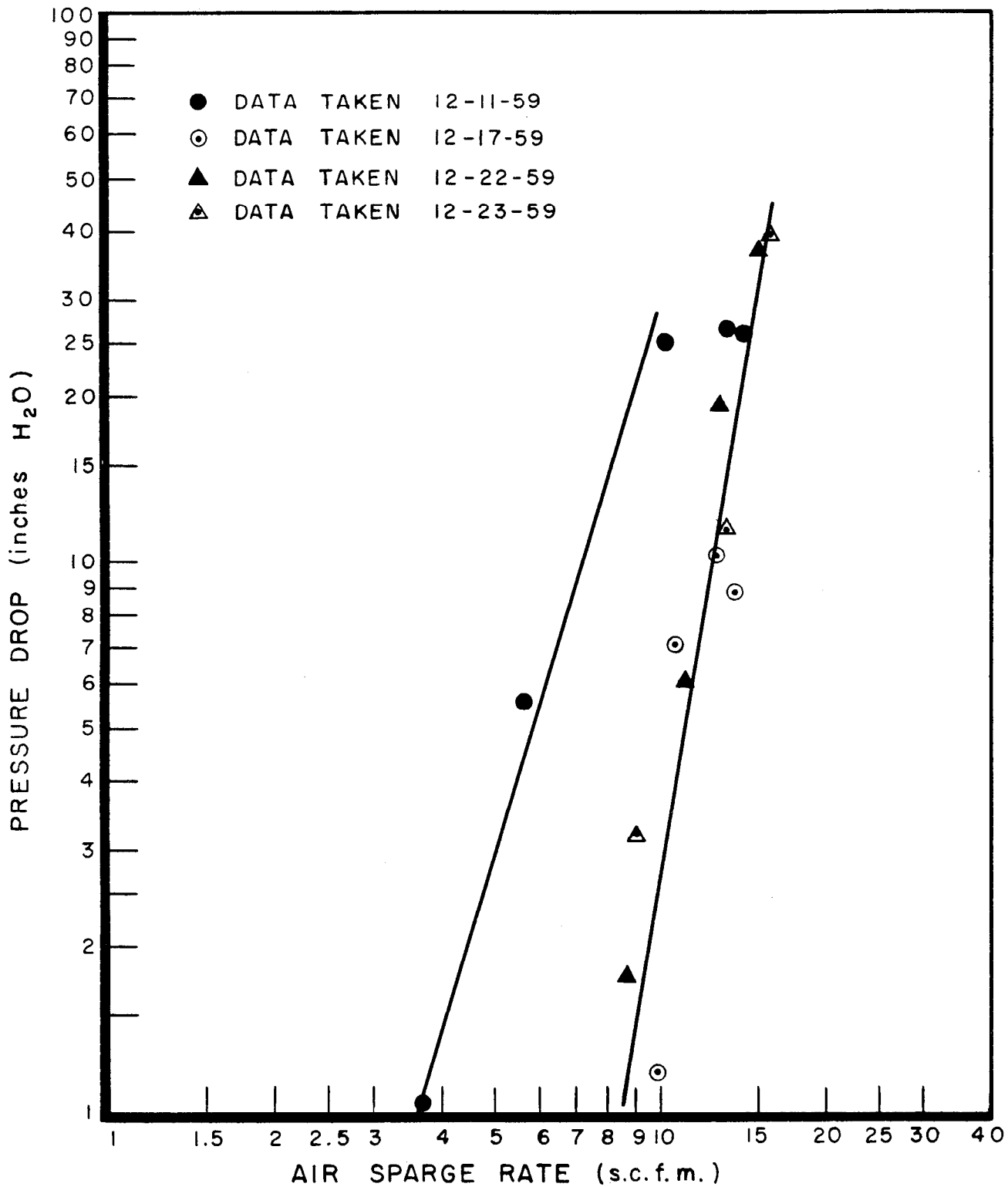

Fig. 21
 EFFECT OF LIQUID IN VOG SYSTEM
 ON BACK PRESSURE IN B-100 BANK

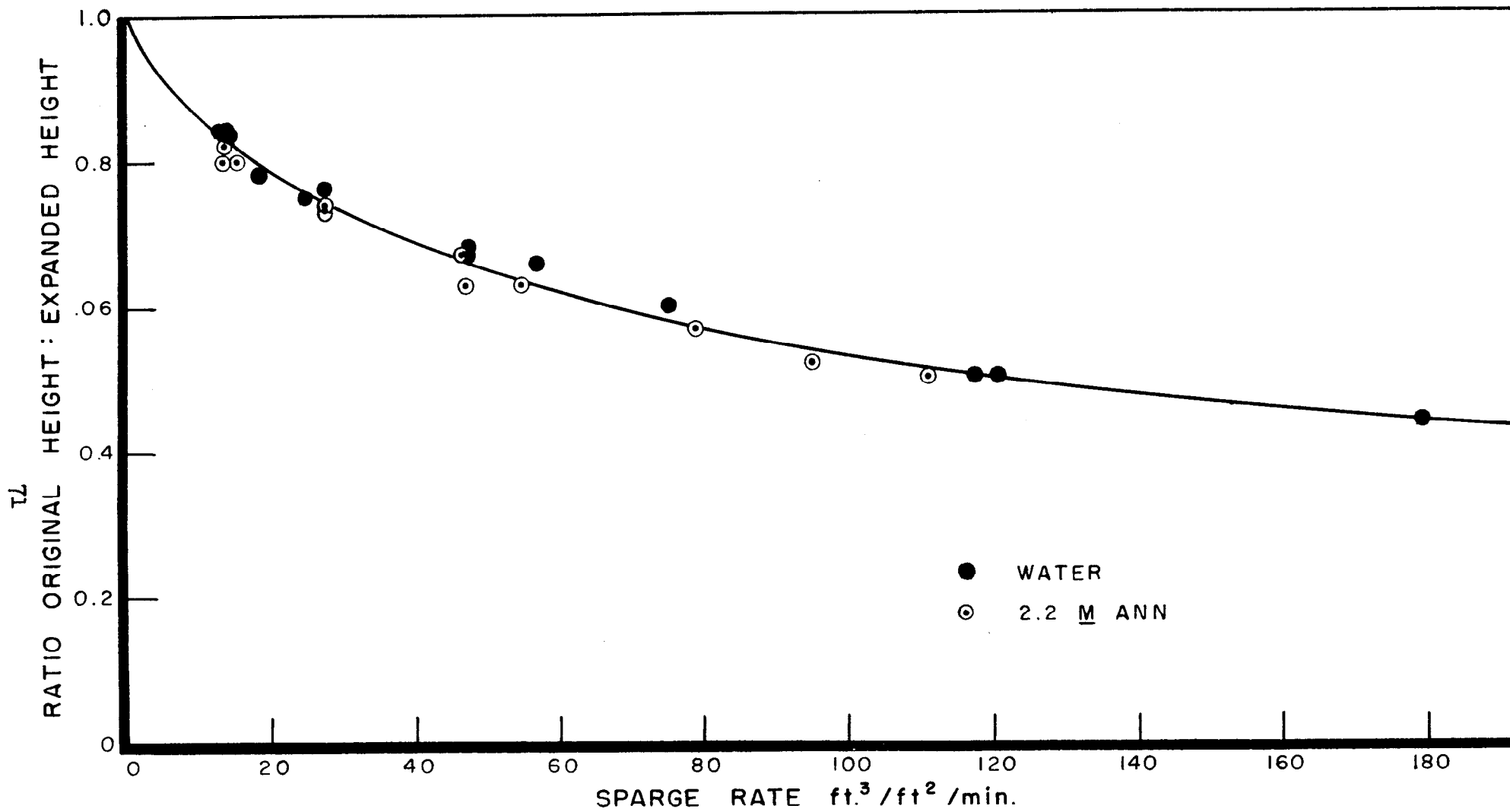
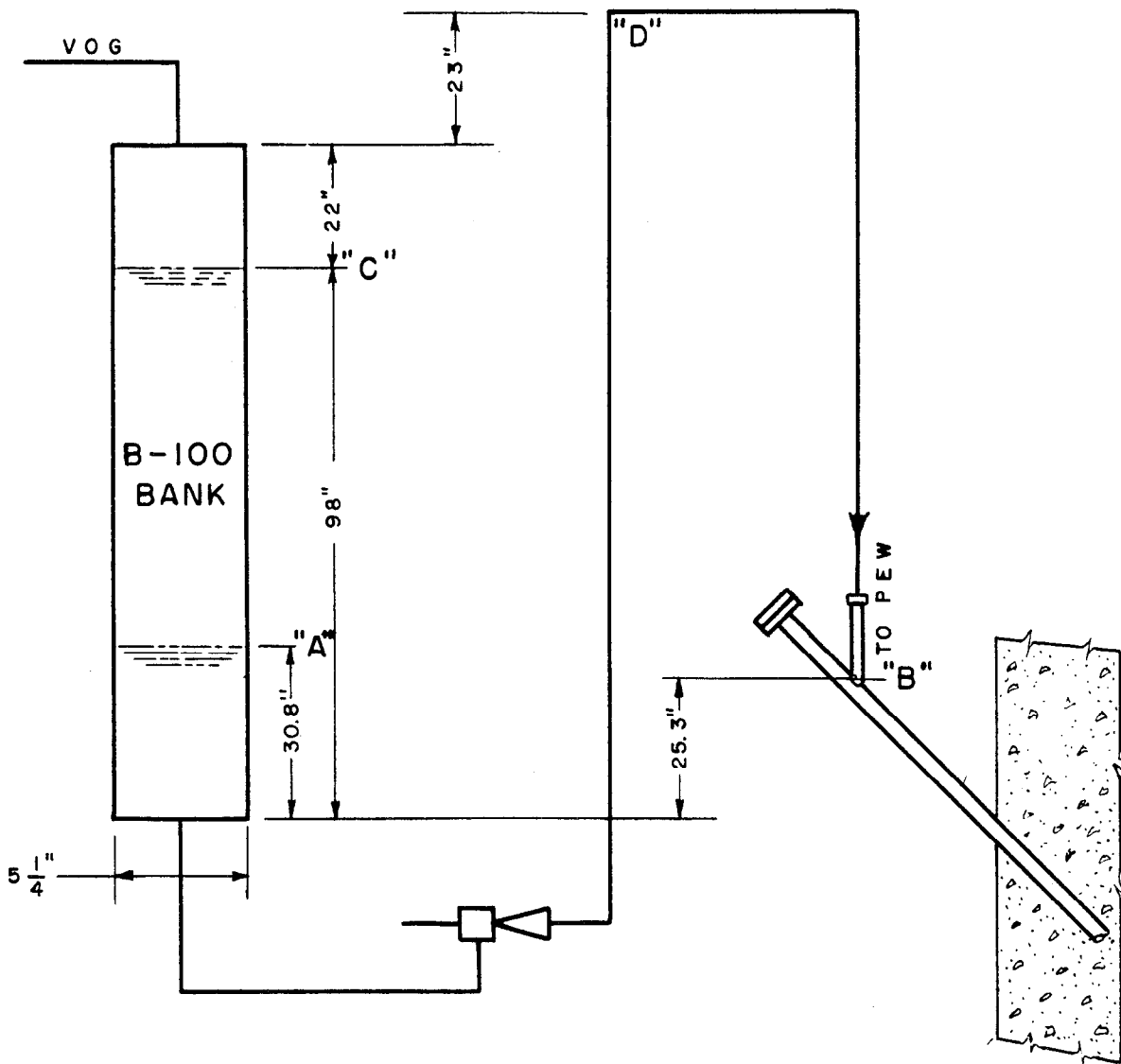

Fig. 22
 EFFECT OF SPARGE RATE ON EXPANSION RATIO
 (4" I. D. x 6' Column)



- "A" - Depth at which siphoning stopped.
- "B" - Height of transfer line enlargement above bottom of B-100 BANK.
- "C" - Depth of UNH solution prior to incident.
- "D" - Height of top of Hydrostatic Seal above B-100 BANK.

Fig. 23
SCHEMATIC DIAGRAM OF B-100 BANK
& PEW JET TRANSFER LINE

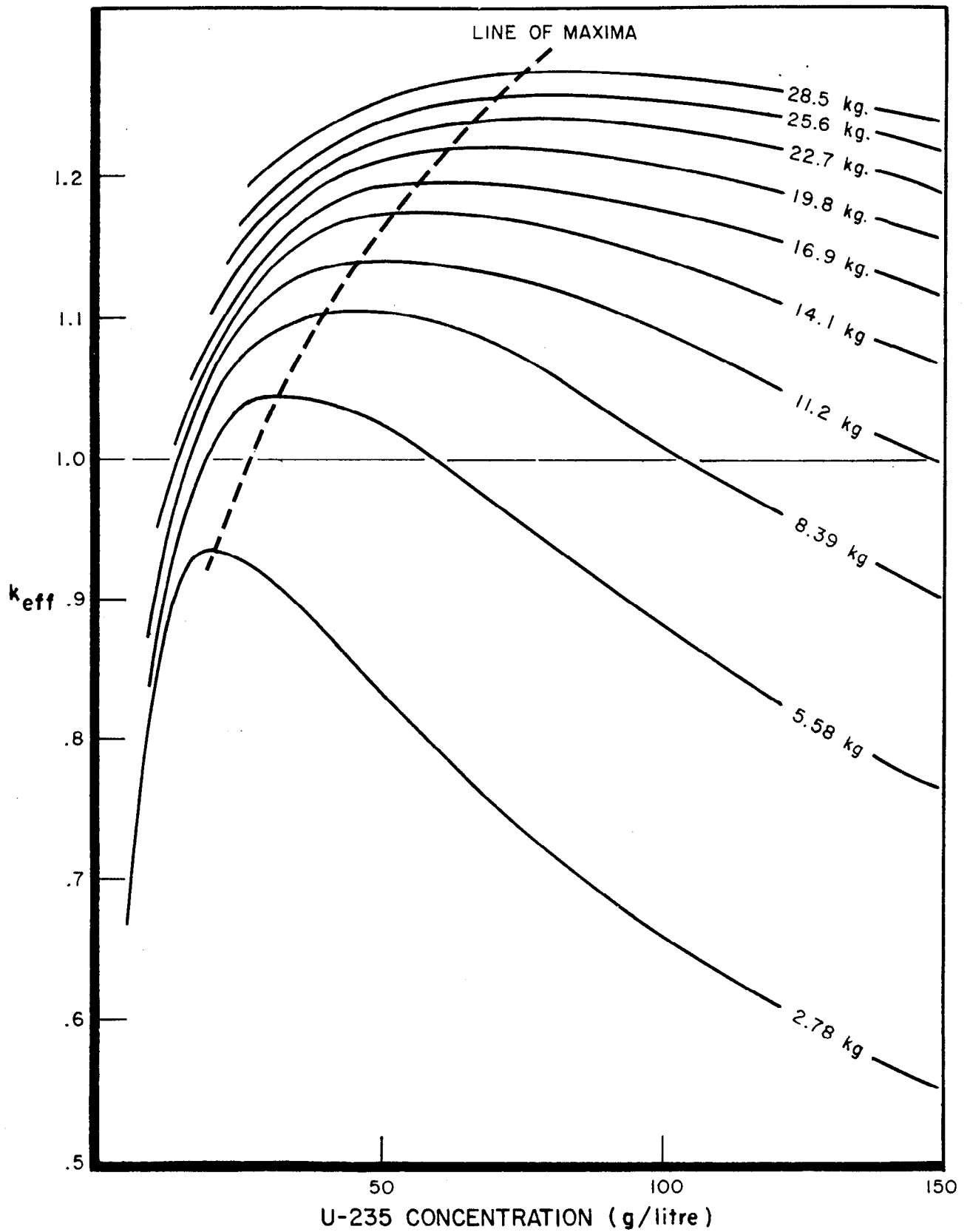

Fig. 24
 PLOT OF k_{eff} AT SUCCESSIVE STATIONARY STATES

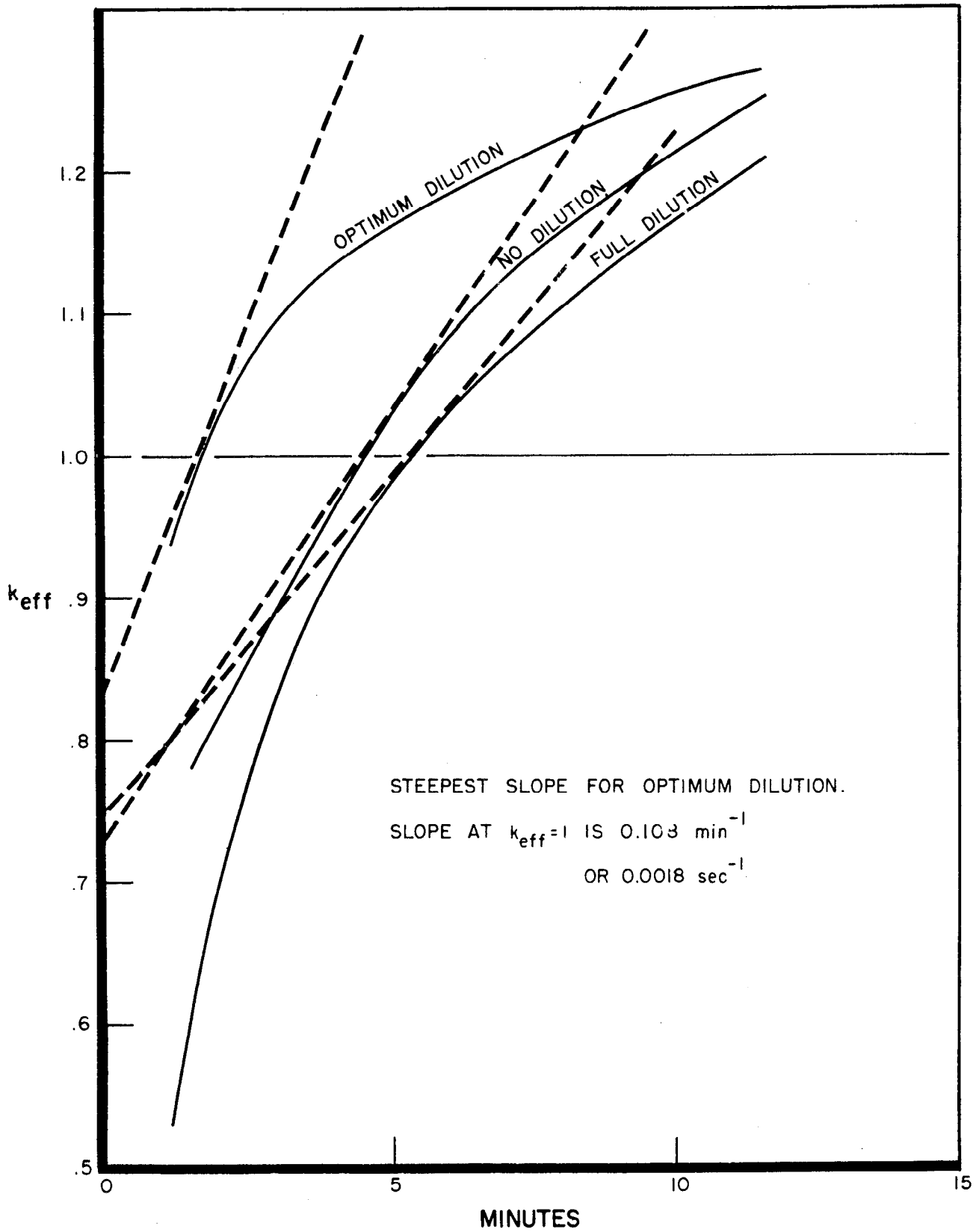

Fig. 25
 PLOT OF k_{eff} VS TIME FOR THREE DEGREES OF MIXING

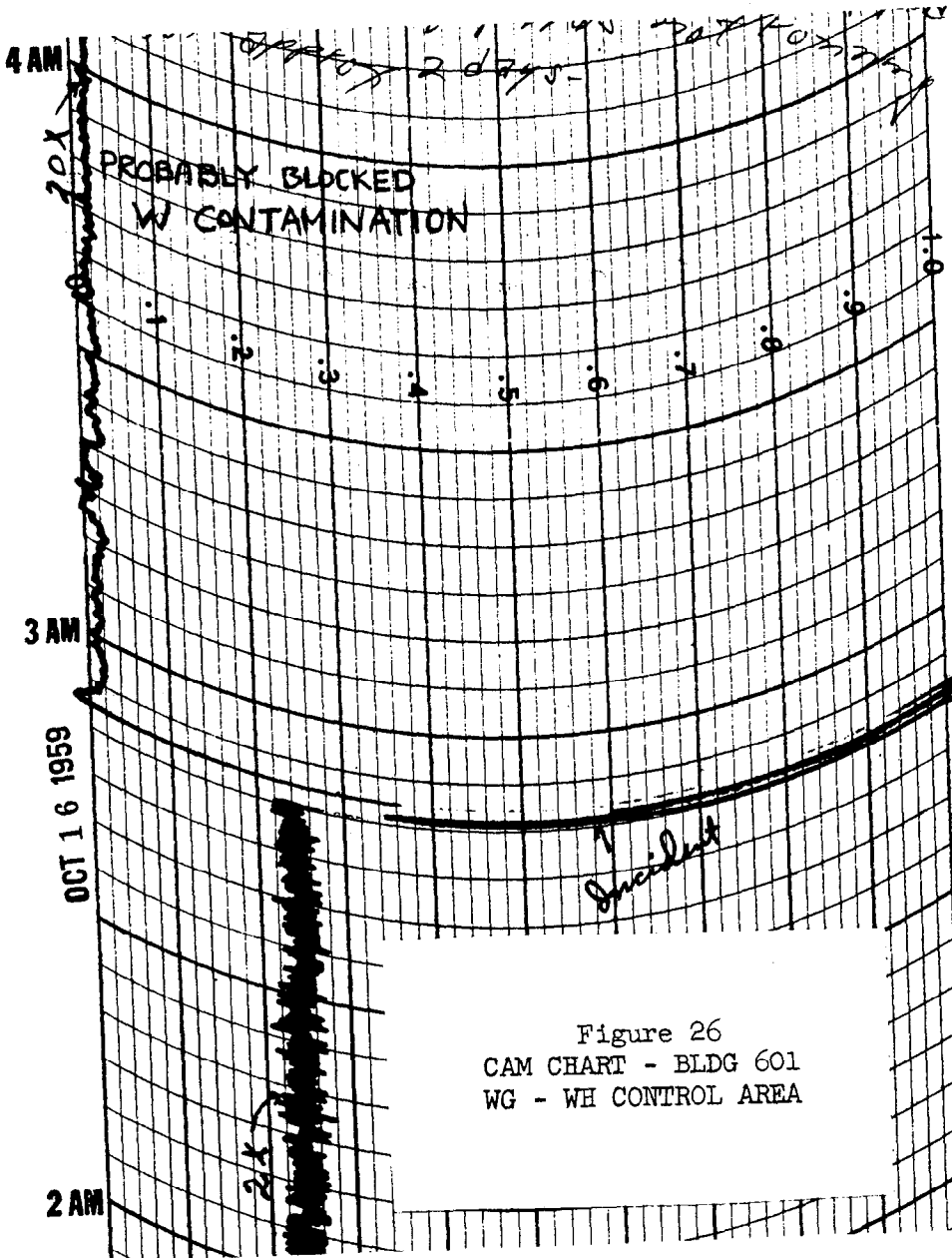

Figure 26
CAM CHART - BLDG 601
WG - WH CONTROL AREA

MADE IN U.S.A. THE ESTERLINE-ANGUS C

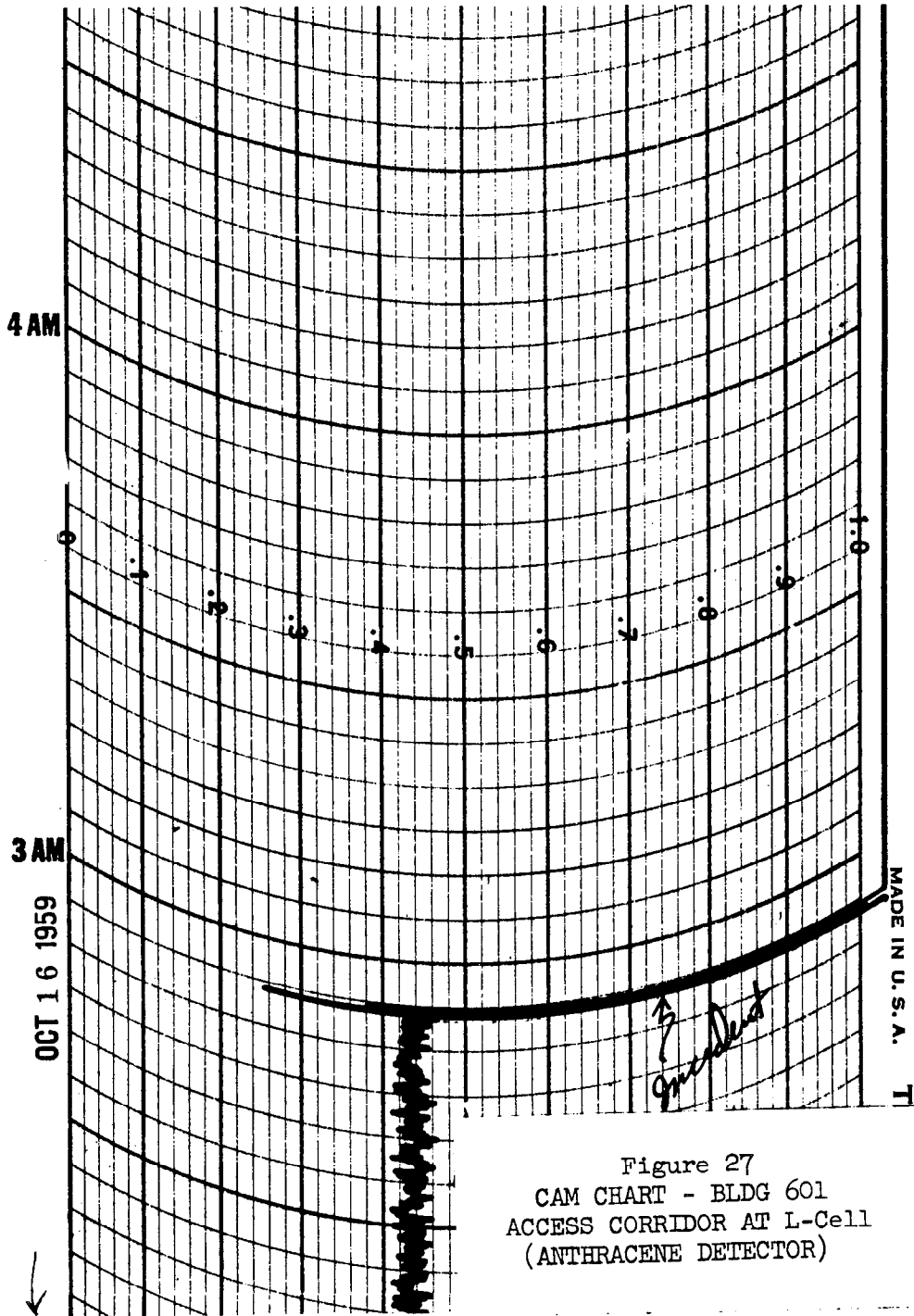

Figure 27
 CAM CHART - BLDG 601
 ACCESS CORRIDOR AT L-Cell
 (ANTHRACENE DETECTOR)

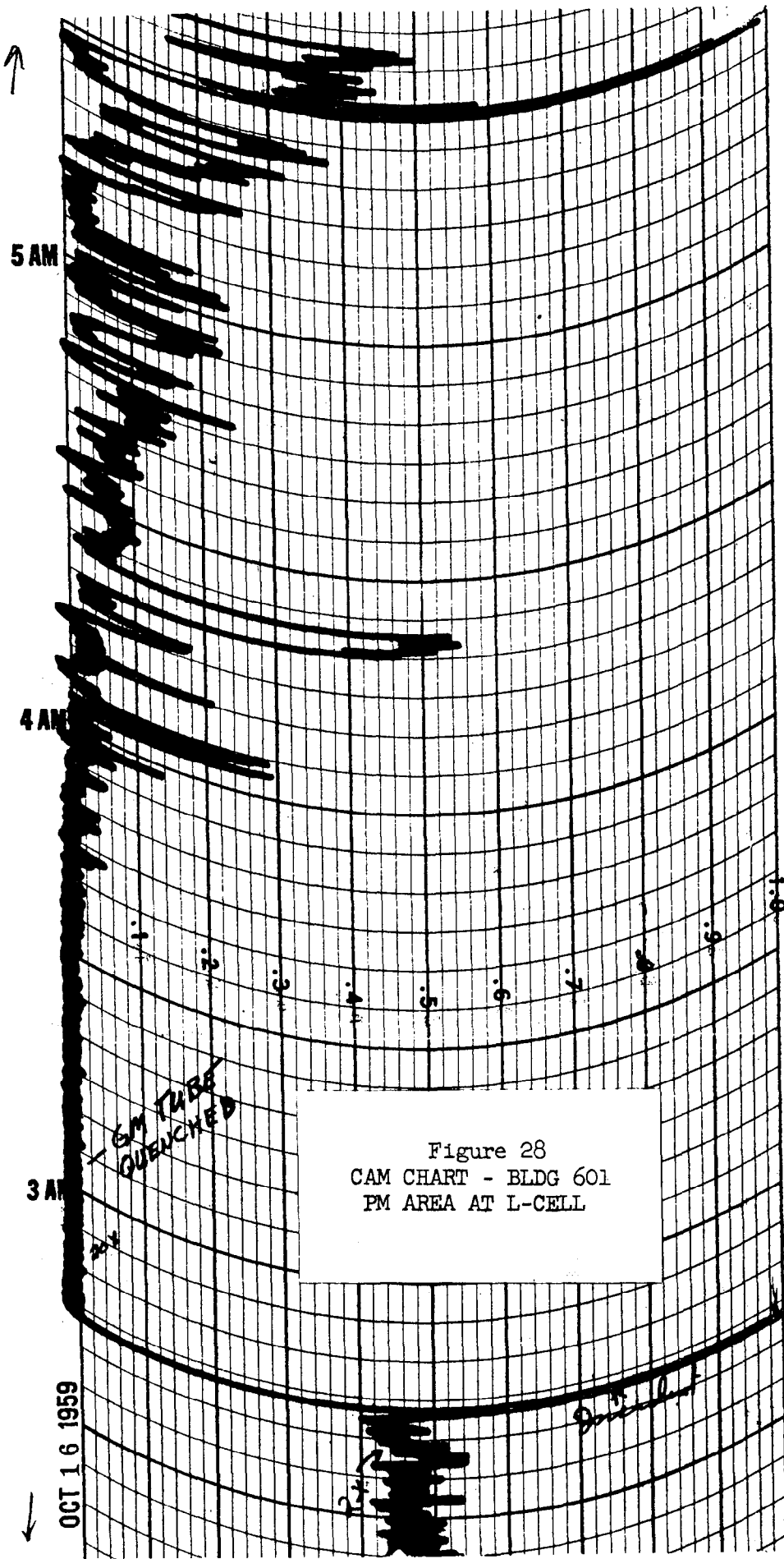
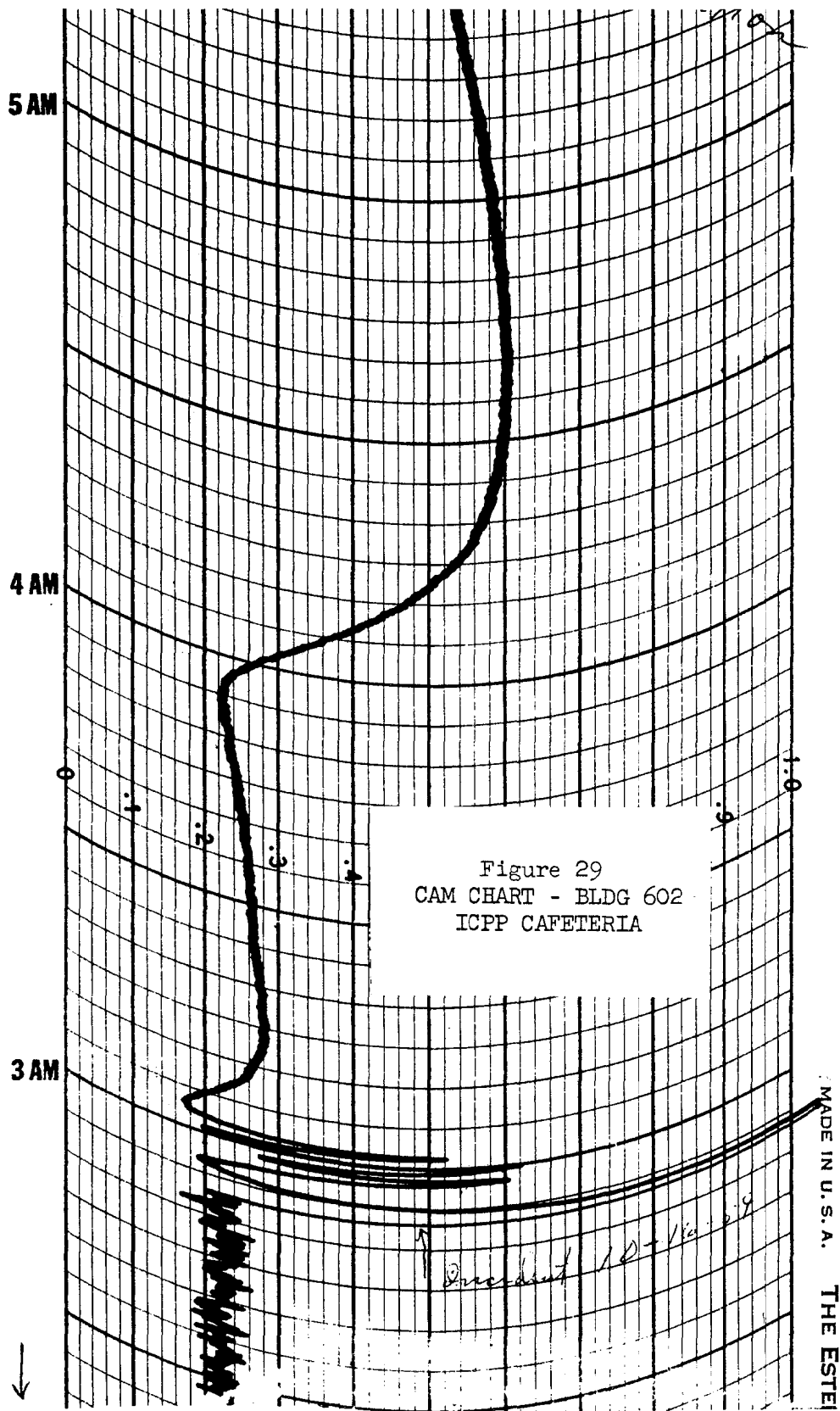

Figure 28
 CAM CHART - BLDG 601
 PM AREA AT L-CELL

MADE IN U.S.A. THE ESTERLI



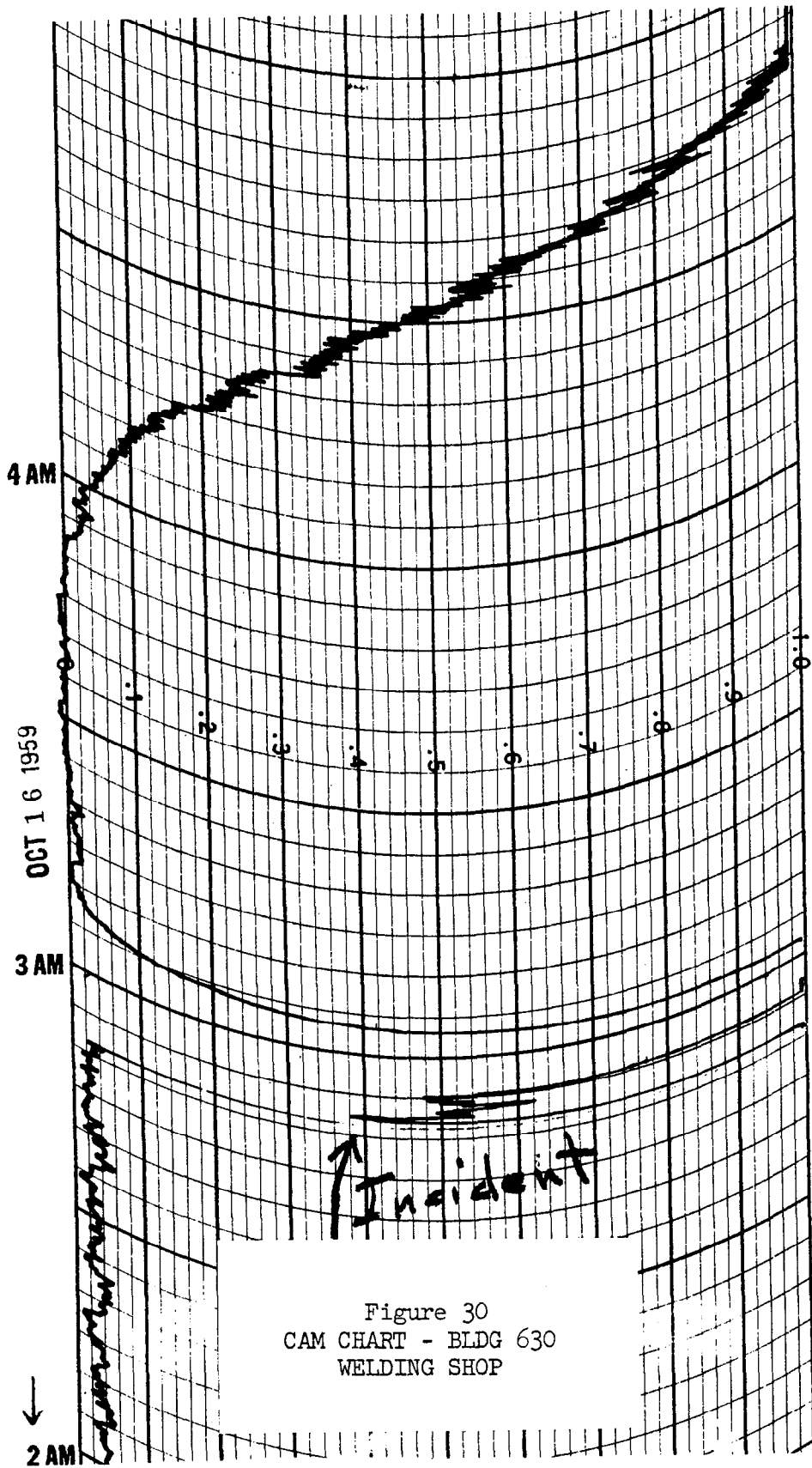
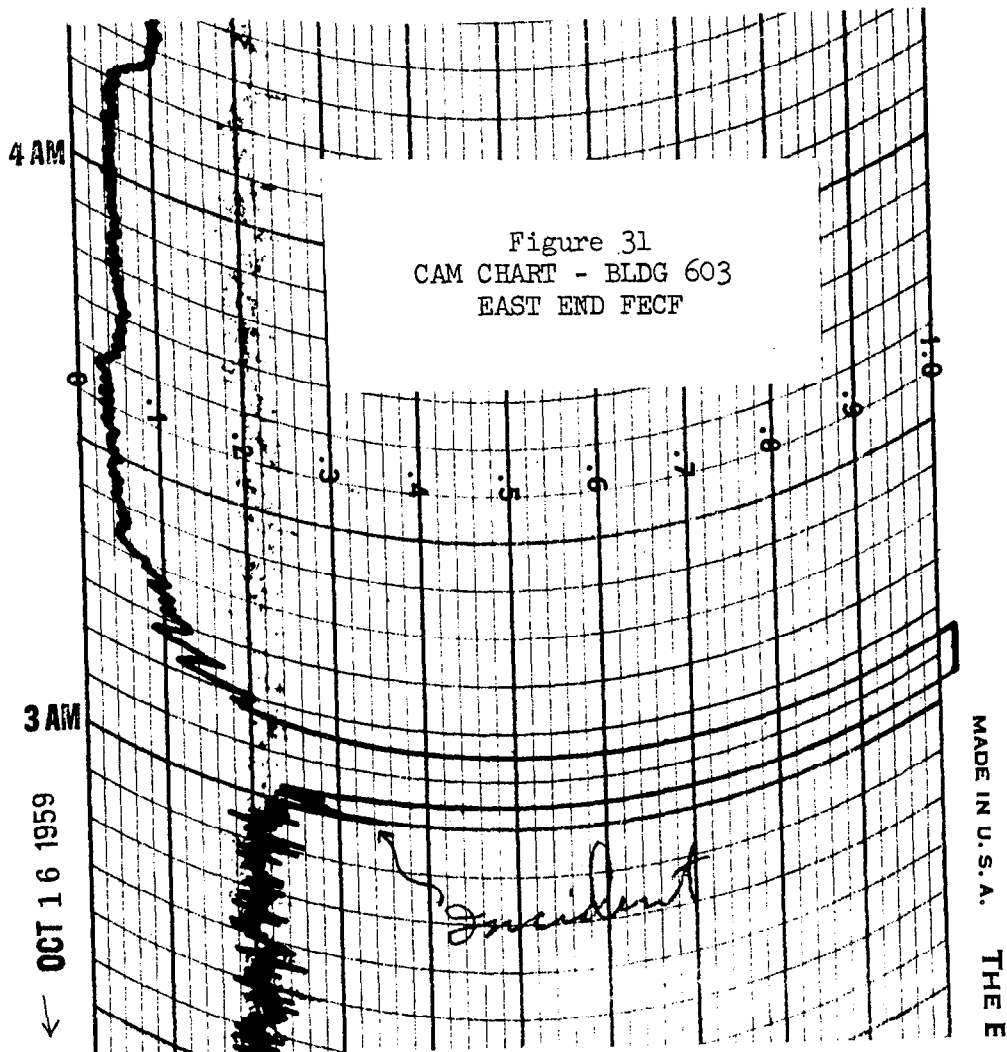
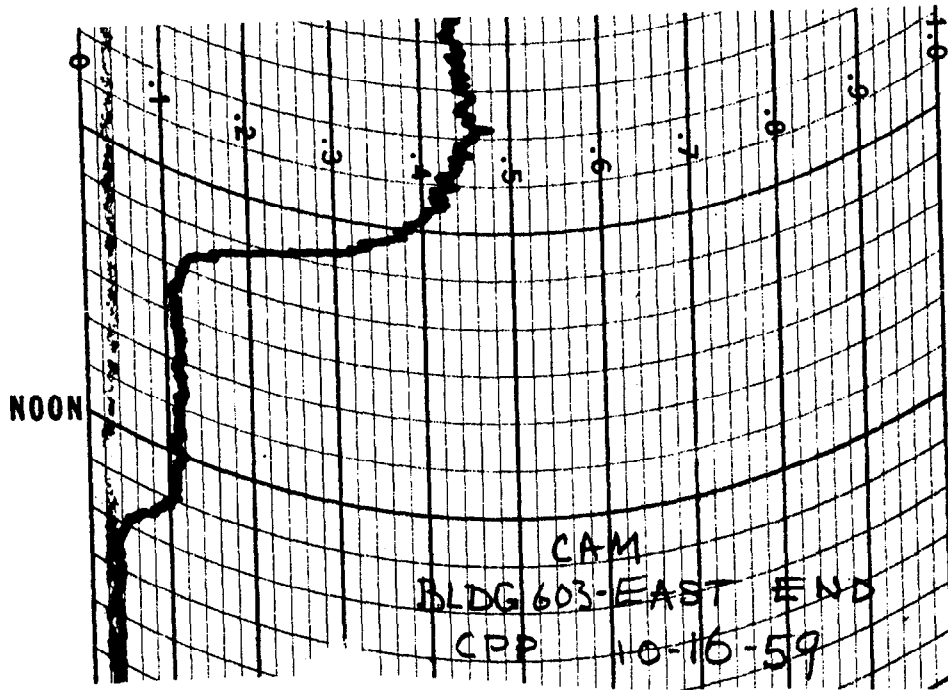
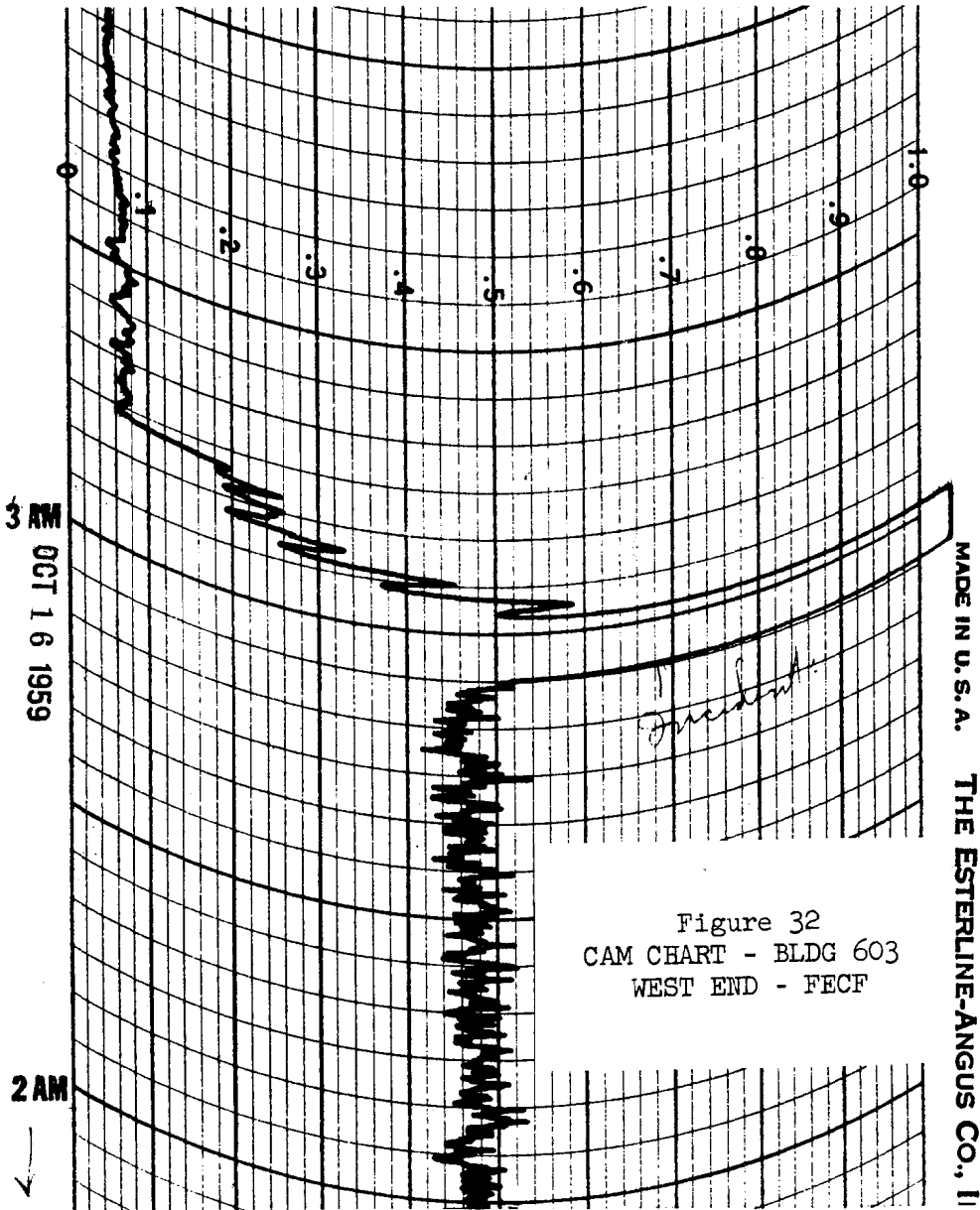
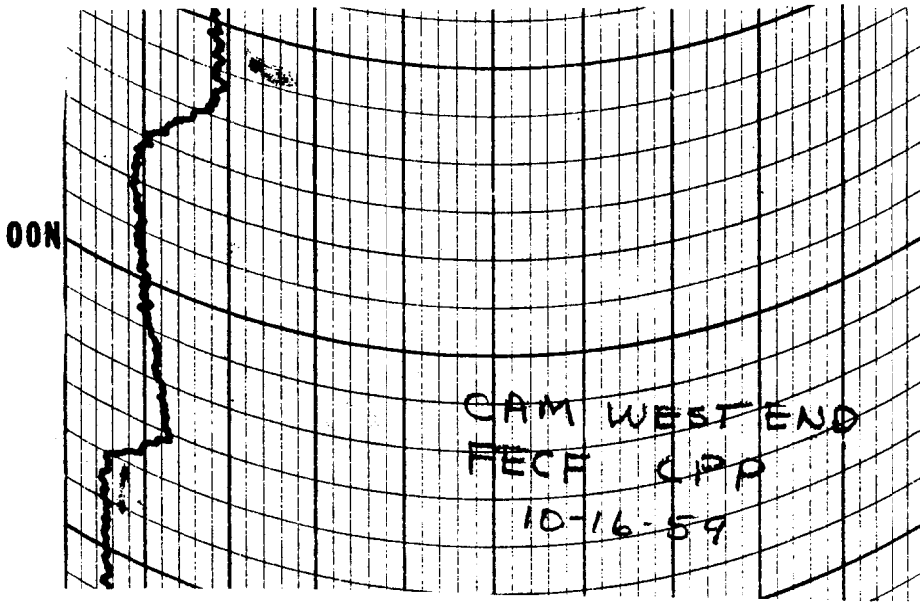
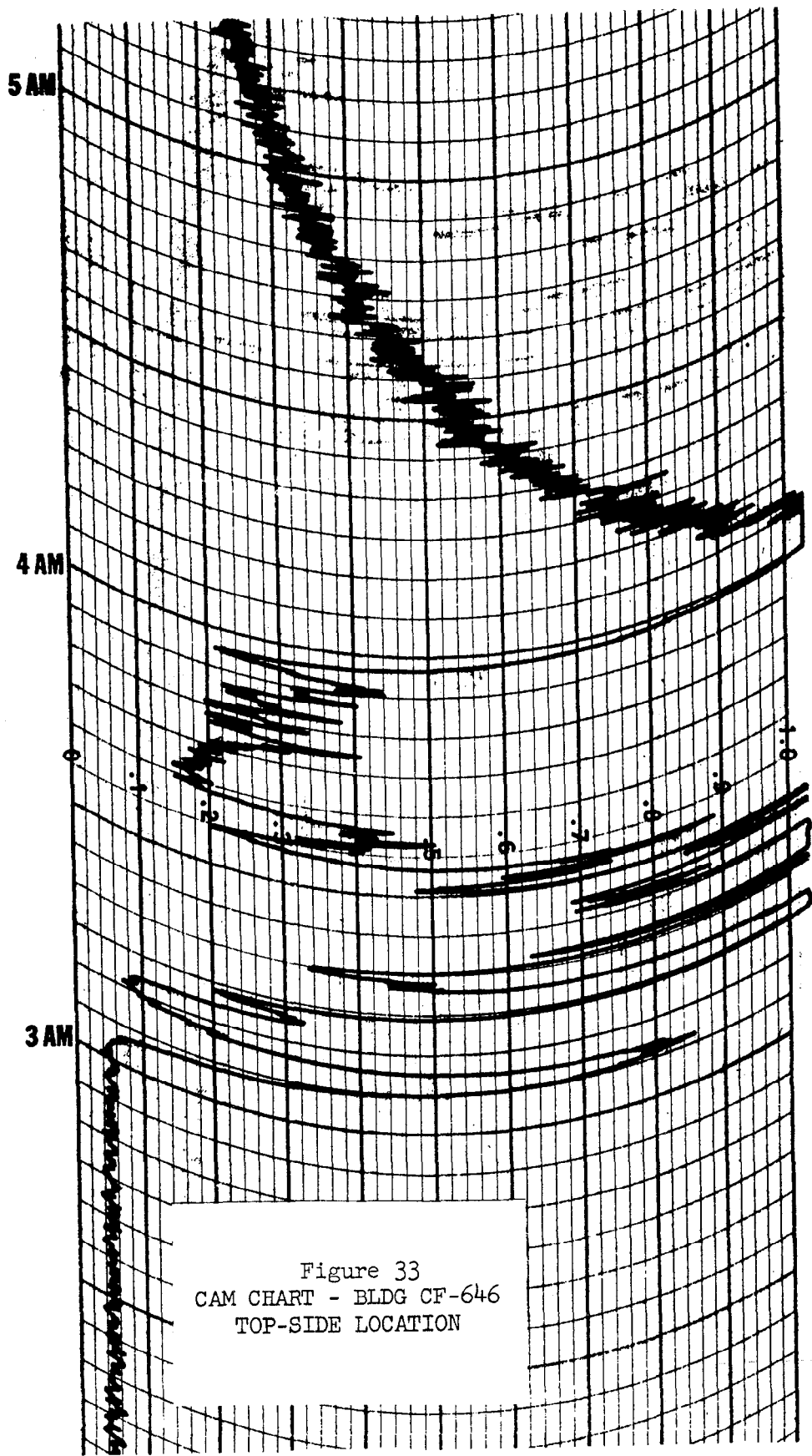

Figure 30
CAM CHART - BLDG 630
WELDING SHOP

MADE IN U.S.A. THE ESTERLINE-ANGUS







PHILLIPS PETROLEUM COMPANY

Idaho Falls, Idaho

SUBJECT

October 28, 1959

Radiochemical Analyses
of CPP Materials
Bur-43-59A

F. P. Vance
O F F I C E

Dear Sir:

Immediately after the early indications of a nuclear reaction at CPP on October 16, 1959 (see Bur-42-59A) it occurred to me that an estimate of the magnitude of the burst would be needed. This thought also must have occurred to Arnold Ayers who called me at home about 10:40 pm the same evening to ask whether it was necessary to undertake such a determination as quickly as possible and to ask who at CPP should carry out the work. I replied, for reasons given below, that such a determination could be made with sufficient accuracy the following week and that either Bill Maeck or Dale Olson at CPP should be able to carry out the required radiochemical analyses. Both, with the assistance of others in their respective groups, have actually contributed to the effort and I have followed their work rather closely to see that appropriate analyses were done and the results correctly calculated.

The radiochemical method of determining the number of fissions that occurred in the solution during the CPP incident is, in principle, quite simple. From a known volume of the solution containing all the non-volatile fission products, a single fission product is isolated and its concentration determined (e.g. in terms of atoms per ml). The number of atoms may be obtained from the absolute disintegration rate of the sample (corrected for losses during isolation and purification), a knowledge of its decay scheme, and of its radioactive decay constant. From the known fission yield of the isolated fission product the corresponding number of fissions per ml is then calculable. Multiplication by the total number of milliliters in the entire solution from which the sample was withdrawn gives the total number of fission events. The preceding of course requires that (1) the entire solution must be uniform in composition so that the sample withdrawn is representative, (2) the volume of the entire solution must be accurately known, and (3) there had been no escape or partial escape of the fission product isolated. Further, as was the case after the CPP incident, if the solution containing non-volatile fission products is divided into more than one portion, the volume of each portion must be accurately known and each portion must be uniform in composition, although it is not necessary that all portions have the same composition. Moreover, it is clear that dilution of any portion

To: F. P. Vance
File: Bur-43-59A
October 28, 1959
Page 2

of the initial solution will not affect the final result since decrease in concentration is exactly compensated by increase in volume.

Choice of the fission isotopes which could be used for radiochemical determination of the number of fissions was rather restricted. Since earlier evidence had indicated extensive escape of the noble fission product gases Kr and Xe (Bur-42-59A) it was not considered wise to employ isotopes of which Xe or Kr were the principal precursors. Further it was not possible to use the longer-lived fission products since there was a high probability that considerable amounts of these would be present from previous processing of fuel. Because no estimate of the magnitude of the burst was available it was best to choose fission products of high fission yield in order to have high sensitivity. The use of short-lived fission products (order of several hours half-life) was not attractive because (1) large corrections for decay would be required, (2) their fission yields and decay schemes are known somewhat less accurately than for longer-lived products and (3) at the time of measurement there would be large contributions to the total radioactivity of the isolated sample by the other intermediate and long-lived isotopes of the same element. For best results then it appeared that a product or products should be chosen which are intermediate in half-life (order of a few days), which do not come through volatile precursors, and which have well-known decay schemes, half-lives and fission yields.

The ideal fission product and the one generally used under the restrictions listed above is Mo-99. It has a half-life of 67 hours so no large decay correction is necessary. It decays by emission of moderately energetic beta rays so that beta counting is not too difficult. It does not come through a gaseous ancestor and its fission yield (6.06%) is high and well-known. There are no other Mo fission products sufficiently long-lived to interfere in counting. Another fission product normally used is Ba-140 (12.5 d half-life, well-known yield [6.4%] and decay scheme) along with its daughter La-140. Its use seemed questionable since some of it is known to come through 16 second Xe-140. Further it is of long enough half-life so that there was a very slight possibility of some of it remaining along with other long-lived fission products from processing of other fuel. (That fresh Ba-140 from a recent Ra-La run could have been mixed with any part of the solution in which the burst occurred has been strongly denied). Despite these objections Ba-140 - La-140 analyses were run and the number of fissions determined from measurement of these isotopes is in fair agreement with the number determined using Mo-99. (The same was true in the Oak Ridge accident at Y-12.) Analyses were also made for Zr-97 (17 hour), but high backgrounds due to Zr-95 (65 d) contamination made interpretation of the results very questionable so they are not reported here.

Four samples were submitted through the analytical laboratory for fission determinations. These are listed in Table I.

Table I

IDENTIFICATION OF SAMPLES

<u>Log No. 16531</u>	This sample was removed from WG-101 at 1900 on October 16th. It is not a representative sample but analyses were run.
<u>Log No. 16532A</u>	This sample was removed from WH-100 at 2230 on October 16th. It is not a representative sample but analyses were run.
<u>Log No. 16528</u>	This is a sample removed from D cell to which part of the solution involved in the incident was transferred. It is a representative sample from a known volume of solution (3300 liters). It was removed at 0215 on October 17th.
<u>Log No. 16552</u>	This sample was removed from WH-100 at 0540 on October 18th. It is a representative sample from a known volume of solution (14700 liters).

In Table I above, the analyses on the first two samples are of little value in determining the total number of fissions in the solution, either because the solution in question had not been sparged and mixed, or because sample recirculation was not possible. The important samples are the last two, which represent solution containing substantially all of the non-volatile fission products produced in the burst. The total volumes of these two solutions are accurately known. These two samples (like the other two) were not homogenous, but contained small amounts of solid material.

The Mo-99 analyses were run by W. J. Maeck using the standard Glendenin analytical procedure. The Mo-99 was determined by absolute beta counting on a end window proportional counter which had been calibrated for isotopes of various energies using NBS standards. The samples were mounted and counted in the same manner as the NBS standards had been. After correction for losses during isolation and purification and for decay since the time of the incident the results listed in Table II were obtained for the measured Mo-99 activity at T = 0 (0300 October 16th). The data are listed in detail in Table II to indicate the precision obtained.

The Ba-140 - La-140 analyses were run by Dale Olson using the standard Ba-140 procedure used in Ra-La work. Absolute gamma counting of the 530 keV gamma-ray (25% abundance) was done on the gamma-ray spectrometer at CPP using freshly separated samples. The parameters used for correcting to absolute disintegration rates were those supplied by R. L. Heath. The method of conversion of absolute disintegration rates/ml to fissions/ml was similar to that shown below for Mo-99. A fission yield of 6.4% was used for the Ba-140. In Table III the data are presented directly in fissions/ml.

Table II

Mo-99 DATA

Sample Log No. 16552 (from 14700 l solution)

Aliquot 1a	1.739×10^6	Mo-99 c/m/ml
Aliquot 1b	1.607×10^6	
Aliquot 2a	1.724×10^6	
Aliquot 2b	<u>1.897×10^6</u>	
Average	1.742×10^6	c/m/ml

Correcting to an absolute disintegration rate (using NBS standards) this average corresponded to 2.613×10^7 d/m/ml or 1.52×10^{11} atoms of Mo-99 at T_0 . Division by the fission yield gave a value of 2.51×10^{12} fissions/ml.

Sample Log No. 16528 (from 3000 l solution)

Aliquot 2a	7.91×10^5	Mo-99 c/m/ml
Aliquot 2b	6.86×10^5	
Aliquot 3a	5.02×10^5	
Aliquot 3b	<u>6.82×10^5</u>	
Average	6.65×10^5	c/m/ml at T_0

Correcting to absolute disintegration rate this corresponded to 0.998×10^7 d/m/ml at T_0 equivalent to 5.80×10^{10} atoms of Mo-99/ml at T_0 and to 9.57×10^{11} fissions/ml.

Table III

Ba-140 DATA

Sample Log No. 16552 (from 14700 1)

Aliquot 1	2.42×10^{12} f/ml
	2.52×10^{12}
Aliquot 2	2.61×10^{12}
	2.57×10^{12}
Average	2.53×10^{12} f/ml

Sample Log No. 16528 (from 3300 1)

Aliquot 1	1.18×10^{12} f/ml
	1.25×10^{12} f/ml
Average	1.22×10^{12} f/ml

Additional samples of Ba-140 were isolated, and, after it had grown in, the 1.6 Mev gamma-ray of La-140 (94% abundance) was counted on the CPP scintillation spectrometer as an indicator of Ba-140. Appropriate corrections were applied to correct for the incomplete saturation of La-140 at the time of the count and the counting data were corrected to fissions/ml in a manner similar to that above. The La-140 data is shown in Table IV directly in fissions/ml.

Table IV

La-140 DATA

Sample Log No. 16552 (from 14700 1)

Aliquot 1	1.74×10^{12} f/ml
Aliquot 2	1.78×10^{12}
Average	1.76×10^{12} f/ml

Sample Log No. 16578 (from 3300 1)

Aliquot 1	1.34×10^{12} f/ml
	1.31
Average	1.32×10^{12} f/ml

To: F. P. Vance
File: Bur-43-59A
October 28, 1959
Page 6

Summarizing the Ba - La-140 and Mo-99 data the total number of fissions is indicated in Table V.

Table V

SUMMARY OF FISSION PRODUCT DATA

Solution from D Cell (3300 1) Sample Log No. 16528

<u>Indicating Isotope</u>	<u>Fissions/ml</u>	<u>Total Fissions</u>
Mo-99	9.6×10^{11}	3.2×10^{18}
Ba-140	1.2×10^{12}	3.9×10^{18}
Ba - La-140	1.3×10^{12}	4.3×10^{18}

Solution from WH-100 (14700 1) Sample Log No. 16552

Mo-99	2.5×10^{12}	3.7×10^{19}
Ba-140	2.5×10^{12}	3.7×10^{19}
Ba - La-140	1.8×10^{12}	2.7×10^{19}

The total fissions represented above are then $\sim 3 \times 10^{18}$ from D cell plus $\sim 3.7 \times 10^{19}$ from solution in WH-100 or $\sim 4 \times 10^{19}$ total fissions. At this writing we have not had time to evaluate the errors associated with the number 4×10^{19} fissions. It is certainly correct to within an order of magnitude, the largest uncertainty being associated with the question of just how representative the samples are.

Neptunium-239 analyses of the four samples provided were run by W. J. Maeck. It was hoped that this information might be of some value in determining the average value of nvt seen by the U-238 involved in the critical vessel. In the calculations there would be considerable error in connection with the value assumed for the U-238 cross section (U-238 has a small well-known thermal cross section but capture in the resonances is responsible for the majority of Np-239 produced). However since there was indication of solution transfer out of the critical vessel during the nuclear reaction, the Np-239 nvt data is of questionable use. This information is of course available to anyone who can use it.

To: F. P. Vance
File: Bur-43-59A
October 28, 1959
Page 7

Another type of radiochemical information obtained was in connection with neutron dosage within the cell where the reaction took place. On October 23rd, a week after the incident, the cell was first entered and a large stainless steel nut and bolt retrieved. The bolt and nut were well contaminated on the outside with fission products, mostly Ba - La-140, the principal contaminating activity remaining at that time. The bolt and nut were "decontaminated" by HP at CPP and then by ourselves by repeatedly washing with hot concentrated nitric acid, hydrofluoric acid, hydrochloric acid, and water.

Using the MTR scintillation spectrometer the nut and the whole bolt were separately scanned by R. P. Schuman and both showed characteristic prominent gamma-rays of Cr-51 (27 d, 0.320 mev γ), Co-58 (71 d, 0.82 γ 's and annihilation radiation), and Fe-59 (45 d, 1.10 and 1.29 Mev γ 's). These nuclides are expected to be formed in the following reactions:

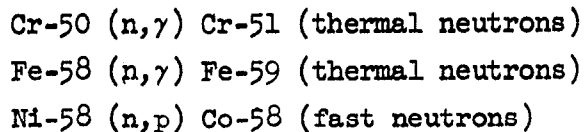

If it is assumed that the first two reactions proceed predominantly with thermal neutrons, that there is no large contribution by resonance energy neutrons, and that no Cr-51 is made in an (n, 2n) reaction on Cr-52, then the induced Cr-51 and Fe-59 activities in the stainless steel may serve as indicators of the time integral of the thermal neutron flux. The third reaction has long been employed as an integrating fast neutron monitor in the MTR and ETR. In this work the cross sections for thermal neutron capture in Cr-50 and Fe-58 have been taken as 0.60 and 0.0032 barns respectively based on the normal element (13.6 barns for the isotope Cr-50 and 1.0 barns for the isotope Fe-58). The Ni-58 (n,p) Co-58 reaction cross section for "fission spectrum" neutrons has customarily been taken by C. H. Hogg at the MTR as 0.091 barns based on the normal element.

Two thin transverse slices were cut from the bolt and weighed for the purpose of absolute gamma-ray counting on the MTR scintillation spectrometer. Photopeaks of the 320 kev gamma of Cr-51 (9% abundance), the 820 kev gamma of Co-58 (99% abundance) and 1290 kev gamma of Fe-59 (43% abundance) were measured quantitatively and the absolute disintegration rates of the respective nuclides were calculated. Corrections were made for decay since the nuclear reaction occurred, and for self absorption of the gamma-rays in the sample. Assuming that the stainless steel was a typical 18-8 alloy so that there were 0.18 of Cr/g, 0.08 g of Ni/g and 0.74 g of Fe/g, and using the cross section values listed above, the following values were calculated for the thermal and fast neutron dosage received by the bolt.

To: F. P. Vance
File: Bur-43-59A
October 28, 1959
Page 8

Table VI

INTEGRATED NEUTRON FLUX SEEN BY S.S. BOLT

<u>Indicating Isotope</u>	<u>γ Energy</u>	<u>nvt</u>
Cr-51	320 kev	1.4×10^{13} thermal n/cm ²
Fe-59	1290 kev	1.7×10^{13} thermal n/cm ²
Co-58	820 kev	1.0×10^{13} fast n/cm ²

A third small slice from the bolt was dissolved and a chromium fraction isolated and purified. The absolute disintegration rate per gram of chromium was determined and a value of 1.2×10^{13} n/cm² (thermal) was calculated. In this analysis and calculation the composition of the stainless steel need not be assumed. The sample was sufficiently thin so that no self-absorption correction was needed. A fourth slice of the stainless bolt was dissolved and a cobalt fraction chemically isolated and purified. This sample gave an nvt value of 6.0×10^{12} n/cm² in fair agreement with the value obtained from the chemically unseparated sample. From this fourth slice of the bolt an iron fraction was also separated and purified for the purpose of unambiguously assigning the previously observed gamma-rays to Fe-59.

With respect to the tank in which the excursion took place, the location of this stainless steel bolt is not exactly clear. It is understood that the bolt was picked up from the floor about two feet from the side of the tank. The position along the horizontal axis of the tank is at present unknown to me. In order to make any further calculations based on data obtained in these activation analyses, more exact information on the relative position of the bolt with respect to the tank is obviously needed. The information we have obtained does serve however to indicate neutron levels within the cell. It is believed that the nvt values quoted are probably correct within a factor of about 3.

It seems inappropriate here to discuss all of the possible sources of error involved in both the neutron activation and fission product results. The limits quoted seem quite realistic to the writer. I hope all of the above information will be of use to you.

Very truly yours,

WHBurgus:cl

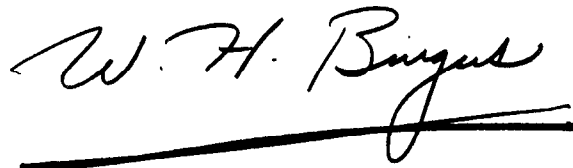

PHILLIPS PETROLEUM COMPANY

RESEARCH AND DEVELOPMENT DEPARTMENT
ATOMIC ENERGY DIVISION

IDAHO FALLS, IDAHO
February 18, 1960

Costs on ICPP Incident
LLL-197-60A

Mr. J. Bion Philipson, Director
Operations Division
Idaho Operations Office
U. S. Atomic Energy Commission
Idaho Falls, Idaho

Attention: Mr. K. K. Kennedy

Gentlemen:

In accordance with your verbal request the following tabulation of out-of-pocket costs related to the October, 1959, nuclear incident at ICPP are furnished for your information.

<u>Classification</u>	<u>Amount</u>
Operating Labor	\$18,100
Health Protection	1,400
Maintenance & Equipment Usage	10,200
Analytical	11,300
Technical Labor	8,700
Chemicals, Materials, Supplies	7,700
Plant Utilities	4,100
Cafeteria, Medical & Other Misc.	300
	<u>\$61,800</u>

While it is possible that some additional charges of a minor nature may be charged to this account we consider the work essentially complete at this time and we do not anticipate the incurrence of any significant additional costs related to this incident.

Very truly yours,

LLLeedy:ls

Assistant Manager, Administration
Atomic Energy Division

cc: Messrs. J. B. Philipson
W. A. Erickson
R. L. Doan

EXHIBIT B

PHILLIPS PETROLEUM COMPANY
Atomic Energy Division
Idaho Falls, Idaho

November 2, 1959

File: Do-600-59A

Mr. J. P. Lyon
CF-610

Effective immediately, the membership of the CPP Safeguard Committee is revised to the following:

D. G. Reid, Chairman
N. J. Rigstad, Vice-Chairman
R. B. Lemon
K. L. Rohde

The duties and responsibilities of the new committee are enlarged to include planning and inspection relevant to CPP processing activities as well as the safeguard responsibilities held by the prior committee. The objectives remain the same - to foresee and avoid any deficiencies in equipment or procedure that might conceivably lead to one or more of the following situations: (1) attainment of criticality in process lines or vessels; (2) unscheduled deflection of fissionable material from the process stream; or (3) unscheduled release of radioactive material from the process stream or from idle equipment.

The committee is requested to hold regularly scheduled meetings on Monday morning of each week to review and approve or reject processing plans or other CPP activities for the coming week. Mr. Ayers will present to the committee in writing at each meeting the details of his proposed operating plans for the coming week, and also for the following weeks to the extent that they are known and requested by the committee to give the necessary lead time for proper consideration and checking prior to approval. It will be the responsibility of the committee members to assure themselves that the equipment which it is proposed to use is in good operable condition and that the procedure to be followed is acceptable from the viewpoint of operational safety. Having reached this conclusion, approval to proceed with the operations as proposed, or as revised as a result of committee discussion, will be given to Mr. Ayers in writing by the committee. The procedure details, the principle items of committee discussion, and the committee approval are to be incorporated into the minutes of the weekly meetings, with copies directed to J. P. Lyon, J. R. Huffman, C. E. Stevenson, R. L. Doan and any others the committee may specify.

Mr. J. P. Lyon
File: Do-600-59A
November 2, 1959
Page 2

If, during the course of CPP operations in accordance with committee approved procedures, any situations are encountered requiring significant departure from these procedures, the operations shall be placed on a stand-by basis to the extent that this can be done safely, until A. L. Ayers has been notified and has given instructions on how to proceed. Before giving such instructions it is mandatory for Mr. Ayers to consult the Chairman of the Safeguard Committee and to secure his concurrence in whatever it is proposed to do. If, in the opinion of the Chairman the situation requires consultation with the other committee members, a special session of the whole committee shall be convened at the earliest practicable time so as to minimize the time that the operations are kept on a stand-by basis pending a decision on how to proceed. Minutes of these special sessions of the committee are to be prepared and distributed as previously indicated.

Mr. Ayers is responsible for seeing that all CPP supervisors and operators understand and abide by the foregoing regulations governing their future operational activities. He is also responsible for initiating the work orders necessary to effect such equipment or piping changes as may be specified by the committee in the interest of safety, and for putting into effect any procedural changes that may be specified. In the event that Mr. Ayers is in disagreement with any of these changes, he may state his case in writing to J. P. Lyon, copy to R. L. Doan, and keep the operations on stand-by until a decision is forthcoming.

By copies of this announcement to CPP Technical I am requesting their continued cooperation in assuring the success of CPP operations. Nothing in this revision of CPP Safeguard Committee activities should be interpreted as relieving the Technical Branch of its responsibility for continued technical surveillance of all CPP processing operations. In particular, it is expected that requests of Mr. Ayers or the CPP Safeguard Committee for flowsheet clarification or plant assistance in the interest of operational safety will be complied with promptly.

RLDoan:rm



cc: J. R. Huffman
C. E. Stevenson
F. M. Warzel
D. G. Reid
N. J. Rigstad
A. L. Ayers
C. M. Slansky
F. P. Vance
K. L. Rohde
R. B. Lemon
R. L. Doan - 2

EXHIBIT C

INTER-OFFICE CORRESPONDENCE

PHILLIPS PETROLEUM COMPANY

Idaho Falls, Idaho

SUBJECT

February 19, 1960

WBL-6-60A-M

MEMORANDUM

To: J. R. Huffman

Subject: Analysis of Critical Incident at I.C.P.P.

SUMMARY:

Arbitrary, but not unreasonable, assumptions have been made as a basis for computations. These show it unlikely that the observed number of fission can be accounted for by a single burst of power. The system went critical, and continued to react for a period of at least half a minute, and probably for several minutes.

cc: R. L. Doan
J. P. Lyon
S. G. Forbes
A. H. Spano
F. H. Tingey
R. B. Lemon
D. G. Reid
File

EXHIBIT D

Development

The following facts are fairly well established:

1. The internal dimensions of the tank were
diameter = 273 cm
length = 263 cm
2. The depth of water in the tank was 29.2 cm.
3. The maximum depth of fluid was about 33.3 cm.
4. The uranyl nitrate solution contained about 152 grams of U-235 per litre.
5. The rate of flow of uranyl nitrate solution into the tank was about 16 litres per minute.
6. The system became critical, and subsequently became subcritical.
7. There were about 4×10^{19} fission, as determined by fission product analysis.

There is no information regarding the degree of mixing that existed between the uranyl solution and the water. No attempt has been made to determine this experimentally for two reasons:

- a) Previous experiments of this type have been valueless (Y-1234);
- b) The factors responsible for strong mixing appeared after criticality was reached, and no facilities are available to perform an experiment under these conditions.

Consequently an entirely different attack has been made which will attempt to establish a reasonable picture of how the system could have behaved.

The system was viewed as a succession of stationary states determined by the total amount of U-235 and total amount of water in the tank at a given instant in time. Each state was subdivided into substates corresponding to a range of dilution varying from no dilution to complete mixing of the uranyl nitrate solution. The value of k_{eff} was calculated for each substate. Figure 1* presents a plot of k_{eff} as a function of the U-235 concentration for several states characterized by the total amount of U-235 present in the system.

It is noted that for each state there is an optimum dilution, ie: a concentration for which k_{eff} is a maximum. Values of k_{eff} are plotted against time in Figure 2* for three types of mixing. It is from this plot that the values for the ramp rate are obtained.

The three paths shown in Figure 2 are definitely arbitrary, but they cover the complete range of possible mixings. Of importance is the fact that under any assumed mixing the rate of increase of reactivity in the neighborhood of $k_{\text{eff}} = 1$ is about the same.

Indefinitely high rates of reactivity increase could be attained if there were violent sloshing of the liquid in the tank. This is definitely a conceivable behavior, but one that is too unfettered to be followed up.

The highest ramp rate - that for optimum dilution - is 1.8×10^{-3} sec^{-1} . This number is of value only as an indication of what may have happened. With comparable ramp rates, SPERT experience indicates a peak power of about 10^8 watts; while KEWB experience indicates about 10^7 watts.

* See Figures 24 and 25

Since fission products are contained in this case and in KEWB, the KEWB value might appear more applicable. However, the volume of this system (≈ 1000 litres), is larger than the KEWB reactor, so the higher value of SPERT might be favored. A compromise of 3×10^7 is as good a guess as anyone could be expected to make.

In any event, there were too many fissions to be accounted for in a single burst. With a maximum power of 30 megawatts, at least a half minute would be required to give the observed number of fissions. A number of shutdown mechanisms, any or all of which could have been in effect, probably prevented the power from coming close to this peak value. Consequently, a reaction lasting several minutes is a more probable picture.

Conclusions:

1. The system could not have gone critical in less than 1.7 minutes after the uranyl solution started flowing into the tank; at this time the system contained about 4 kg of U-235.
2. For the cases considered, the maximum ramp rate was about $1.8 \times 10^{-3} \text{ sec}^{-1}$.
3. It is doubtful that the maximum power exceeded 30 megawatts.
4. The reaction continued for not less than half a minute, and probably for several minutes.

Outline of Computation

1. The volume of fluid in the tank was computed for a set of depths ranging from the depth of water originally in the tank to a slightly greater depth than the maximum recorded.
2. For each depth there is a corresponding volume increment over the initial volume. This represents the volume of uranyl solution added, a solution assumed to contain 152 grams of U-235 per litre.
3. Values of k_{eff} were computed for each added volume for a range of concentrations ranging down from 152 grams per litre to that corresponding to complete dilution of the uranyl solution.
4. A value of k_{eff} was found from the two-group formula for a bare reactor:

$$k_{\text{eff}} = \frac{k_{\infty}}{(\tau B^2 + 1)(L^2 B^2 + 1)} .$$

where k_{∞} , and L^2 are functions of the U-235 concentration, and B^2 is a function of the assumed geometrical shape of the reacting system.

5. The reacting system was assumed to be a bare parallelepiped, whose X-direction was augmented with a reflector saving of 7.5 cm. The y-z dimensions were chosen so that $z^2 = \bar{h}^2$, and $yz = S$, where S is the area of the circular segment representing the cross section of fluid in the tank.

\bar{h}^2 is the square of the depth, averaged along the width. This value was taken as best accounting for leakage in the z-direction.

The value of x was allowed to cover a range corresponding to the volume required for no dilution to that required for complete dilution.

6. The computations were programmed for the IBM 650. The input data is:

D = Diameter of cylinder (cm)
 FL = Length of cylinder (cm)
 HO = Initial depth of water (cm)
 H1 = Final depth of fluid (cm)
 CO = Concentration of U-235 (grams cm^{-3})
 E = Reflector Saving (cm)
 FMM = Number of incremental steps in fluid depth from HO to H1
 FNN = Number of incremental steps from no dilution to complete dilution.

The program delivers:

H = Depth of fluid in cylinder
 C = Concentration of uranium
 UKG = kilograms of U-235 in cylinder
 FKE = k_{eff} for state (H,C)

The input data is:

D	273.05
FL	263.52
HO	29.20
H1	33.30
CO	0.152
FMM	10.
FNN	20.

7. The values of nuclear constants used are:

$$\sigma_a^u = 610 \text{ barns}$$

$$\Sigma^{\text{water}} = 0.197 \text{ cm}^{-1}$$

$$\tau = 31 \text{ cm}^2$$

$$D = 0.162 \text{ cm}$$

8. The formulae used in the program are:

$$S = a^2 \left(\frac{\pi}{2} - \sin^{-1} \eta - \eta \rho \right)$$

$$\frac{h^2}{a^2} = \left[\frac{1}{3} (2 + \eta^2) - \frac{\eta}{\rho} \frac{\sin^{-1} \rho}{\rho} \right]$$

$$B^2 = \pi^2 \left[\frac{1}{\frac{h^2}{a^2}} + \frac{h^2}{S^2} + \frac{1}{(x + 7.5)^2} \right]$$

Where $(1 - \eta)$ is the depth of the spherical segment and $\rho = \sqrt{1 - \eta^2}$; both η and ρ are for a circle of unit radius; "a" is the radius of the tank, S is the cross sectional area of the fluid in the tank; and x is the length of the portion of fluid containing U-235. The constant 7.5 is a reflector savings, to account for reflection by the water bounding the uranyl solution.

W B Lewis