

**NUCLEAR CRITICALITY TECHNOLOGY**

# **A Review of Criticality Accidents**

**William R. Stratton**

revised by  
**David R. Smith**

**March 1989**

**NUCLEAR CRITICALITY TECHNOLOGY**



**NUCLEAR CRITICALITY  
INFORMATION SYSTEM  
US Department of Energy  
Office of Safety Appraisals**

## DISCLAIMER

This document was prepared as an account of work sponsored by an agency of the United States Government. Neither the United States Government nor the University of California nor any of their employees, makes any warranty, express or implied, or assumes any legal liability or responsibility for the accuracy, completeness, or usefulness of any information, apparatus, product, or process disclosed, or represents that its use would not infringe privately owned rights. Reference herein to any specific commercial products, process, or service by trade name, trademark, manufacturer, or otherwise, does not necessarily constitute or imply its endorsement, recommendation, or favoring by the United States Government or the University of California. The views and opinions of authors expressed herein do not necessarily state or reflect those of the United States Government or the University of California, and shall not be used for advertising or product endorsement purposes.

Work performed under the auspices of the U.S. Department of Energy by Lawrence Livermore National Laboratory under Contract W-7405-Eng-48.

# **A Review of Criticality Accidents**

**William R. Stratton**

revised by  
**David R. Smith**

**March 1989**

## Foreword

The *Review of Criticality Accidents* by Wm. R. Stratton was published in 1967 by the Los Alamos Scientific Laboratory. In this revision of his report we have taken quite freely from Dr. Stratton's work. In some cases we have used his descriptions and analyses verbatim, in others we have "edited" his work to fit current style. We have kept most of the references he cited, however, a few have been omitted because they are not available.

## Table of Contents

	Page
Abstract.....	1
Introduction.....	1
I. Process Accidents.....	3
I-1 Y-12 Chemical Processing Plant, Oak Ridge, Tenn., June 16, 1958.....	3
I-2 Los Alamos Scientific Laboratory, Dec. 30, 1958.....	5
I-3 Idaho Chemical Processing Plant, Idaho Reactor Testing Area, Oct. 16, 1959.....	9
I-4 Idaho Chemical Processing Plant, Idaho Reactor Testing Area, Jan. 25, 1961.....	9
I-5 Hanford Works, Richland, Wash., April 7, 1962.....	10
I-6 Wood River Junction, R. I., Scrap Recovery Plant, July 24, 1964.....	11
I-7 Windscale Works, Great Britain, Aug. 24, 1970.....	12
I-8 Idaho Chemical Processing Plant, Oct. 17, 1978.....	15
II. Reactor and Critical Experiment Accidents.....	19
A. Fissile Solution Systems.....	19
II-A.1 Los Alamos Scientific Laboratory, Dec. 1949.....	19
II-A.2 Hanford Works, Richland, Wash., Nov. 16, 1951.....	19
II-A.3 Oak Ridge National Laboratory, May 26, 1954.....	20
II-A.4 Oak Ridge National Laboratory, Feb. 1, 1956.....	20
II-A.5 Oak Ridge National Laboratory, Jan. 30, 1968.....	23
B. Bare and Reflected Metal Assemblies.....	24
II-B.1 Los Alamos, New Mexico, Aug. 21, 1945.....	24
II-B.2 Los Alamos, New Mexico, May 21, 1946.....	24
II-B.3 Los Alamos Scientific Laboratory, Feb. 1, 1951.....	28
II-B.4 Los Alamos Scientific Laboratory, April 18, 1952.....	29
II-B.5 Los Alamos Scientific Laboratory, Feb. 3, 1954.....	30
II-B.6 Los Alamos Scientific Laboratory, Feb. 12, 1957.....	30
II-B.7 Los Alamos Scientific Laboratory, June 17, 1960.....	34
II-B.8 Oak Ridge National Laboratory, Nov. 10, 1961.....	35
II-B.9 Lawrence Livermore Laboratory, March 26, 1963.....	35
II-B.10 White Sands Missile Range, May 28, 1965.....	36
II-B.11 Aberdeen Proving Ground, Md., Sept. 6, 1968.....	37
C. Moderated Metal or Oxide Systems.....	38
II-C.1 Los Alamos, New Mexico, June 6, 1945.....	38
II-C.2 Chalk River Laboratory, late 1940s or early 1950s.....	39
II-C.3 Argonne National Laboratory, June 2, 1952.....	39
II-C.4 Atomic Energy of Canada, Ltd., Chalk River, Ontario, Dec. 12, 1952.....	40
II-C.5 Argonne National Laboratory, Idaho Reactor Testing Area, July 22, 1954.....	40
II-C.6 Vinca, Yugoslavia, Oct. 15, 1958.....	42
II-C.7 Centre d'Etudes Nucleaires de Saclay, France, March 15, 1960.....	43

II-C.8 Stationary Low-Power Reactor No. 1, Idaho Reactor Testing Area, Jan. 3, 1961.....	43
II-C.9 Spert Reactor Test, Idaho Reactor Testing Area, Nov 5, 1962.....	44
II-C.10 Mol, Belgium, Dec. 30, 1965.....	45
II-C.11 The RA-2 Facility, Buenos Aires, Argentina, Sept. 23, 1983.....	46
D. Miscellaneous Systems.....	47
II-D.1 Los Alamos, New Mexico, Feb. 11, 1945.....	47
II-D.2 The U.S.S.R, 1953 or 1954 .....	47
II-D.3 Argonne National Laboratory, Idaho Reactor Testing Area, Nov. 29, 1955.....	48
II-D.4 Los Alamos Scientific Laboratory, July 3, 1956.....	48
II-D.5 The Reactor Testing Area, Idaho Falls, Idaho, Nov. 18, 1958.....	50
II-D.6 Los Alamos Scientific Laboratory, Dec. 11, 1962.....	50
III. Power Excursions and Quenching Mechanisms.....	51
Summary.....	59
References.....	65
Appendix: Chernobyl Nuclear Power Station, The Ukraine, Soviet Union.....	69

## List of Figures

	Page
1. 55-gal drum in which the 1958 Y-12 process accident occurred.....	4
2. Process vessel in which the 1958 Los Alamos plutonium solution accident occurred.....	7
3. Configuration of the 850-L plutonium solution tank prior to the accident.....	8
4. The British Nuclear Fuels, Ltd., process line at Windscale.....	13
5. Solution transfer in the Windscale process line.....	14
6. H-100 Scrub Column.....	16
7. First-cycle extraction line, Idaho Chemical Processing Plant.....	17
8. The ORNL uranium solution assembly showing the normal and detached positions of the central poison rod.....	21
9. Plutonium sphere partially reflected by tungsten-carbide blocks.....	24
10. Configuration of beryllium reflector shells prior to the accident May 21, 1946.....	25
11. Calculated fission rate for 6.2-kg plutonium sphere.....	26
12. Calculated total fissions vs time for 6.2-kg plutonium sphere.....	27
13. The LASL aquarium assembly machine employed for measurements of critical separation distances.....	29
14. The LASL Lady Godiva assembly (unreflected enriched-uranium sphere) in the scrambled configuration.....	31
15. Lady Godiva after the excursion of February 3, 1954.....	33
16. Burst rod and several sections of Lady Godiva showing oxidation and warpage that accompanied the second accident.....	34
17. The destructive excursion in BORAX, July 22, 1954.....	41
18. The LASL Honeycomb assembly machine.....	49
19. Energy model computation of power vs time and energy release vs time for an initial reactivity of $1.2 \beta$ above delayed critical for neutron lifetime values of $l = 10^{-8}$ , $10^{-6}$ , and $10^{-4}$ s.....	53
20. Energy model computation of power vs. time for an initial reactivity of $1.0 \beta$ above delayed critical for neutron lifetime values of $l = 10^{-8}$ , $10^{-6}$ , and $10^{-4}$ s.....	54
21. Distribution in burst wait times after quick (about 50 ms) insertion of $1.05 \beta$ in Godiva-II.....	56

## List of Tables

1. Process Accidents.....	61
2. Reactor and Critical Experiment Accidents.....	62

## ABSTRACT

Criticality accidents and the characteristics of prompt power excursions are discussed. Forty-one accidental power transients are reviewed. In each case where available, enough detail is given to help visualize the physical situation, the cause or causes of the accident, the history and characteristics of the transient, the energy release, and the consequences, if any, to personnel and property.

Excursions associated with large power reactors are not included in this study, except that some information on the major accident at the Chernobyl reactor in April 1986 is provided in the Appendix.

## INTRODUCTION

Since the beginning of the atomic energy industry, there have been times when the power of fissile systems became uncontrollably large because of unplanned or unexpected changes in system reactivity. In some cases, moderate power excursions were planned but, for a variety of reasons, the energy release was significantly larger than expected.

Here we review 41 accidents in which the reactivity and fission power level were uncontrolled and increased independent of any efforts of the operators or experimenters. The reactivity exceeded prompt criticality in many of the excursions. Wherever possible, an estimate of the maximum reactivity is given. While personal injury and significant property damage did not necessarily occur, unfortunately, nine deaths did result from seven of the power excursions.

Of these 41 unexpected and often complicated events, the question may be asked, "How many can be understood in a satisfactorily quantitative fashion?" It can be done in several cases. In others, important parameters can be determined within limits. In a few cases we must restrict ourselves to qualitative statements of the events. While a complete analytical description of all events would be interesting and would satisfy scientific curiosity, it is unlikely that such a description will ever be possible because the available data are inadequate to provide more than an estimate of yield.

For many of the accidents, estimates of the power history of the event are mentioned. Most of these were developed by Stratton during the preparation of his earlier work<sup>1</sup> and are not further referenced. Subsequent studies using more sophisticated computational techniques are referenced specifically.

The causes and results of the various excursions are discussed qualitatively, with some mention of their analyses. Accidents that occurred in fissile material-processing facilities are discussed in Part I. These events are often used in nuclear criticality safety lectures to illustrate the subtle and complex factors that contributed to the accidents and to illustrate principles of criticality safety. Events involving critical facilities and low-power reactors are discussed in Part II. In Part III there is a brief mention of the large amount of experimental and theoretical work in this



field. The summary of this review contains a brief discussion of production plant problems.

It is hoped that this report will illuminate some of the causes of accidental excursions and aid in understanding the physical phenomena that control their behavior. While such a study is of interest in itself, of more importance is the possibility that with knowledge and time we may be able to limit the occurrence or magnitude of such excursions and thus minimize or eliminate radiation injuries and property damage.

## I. PROCESS ACCIDENTS

The process accidents described here are characterized by spike yields of limited size (about  $10^{16}$  to  $10^{17}$  fissions) in which little or no damage occurred to process equipment. Prompt response to criticality accident alarm systems saved the lives of persons more than a few meters from the reaction vessel. Administrative decisions, rather than the severity of the accident, appear to have determined the length of facility downtime following an accident.

### I-1 Y-12 Chemical Processing Plant, Oak Ridge, Tenn., June 16, 1958<sup>2,3,4</sup>

*Uranium process solution combined with water in 55-gal drum; unshielded operation.*

The accident occurred in a processing area in which enriched uranium was recovered from various materials by chemical methods in a complex of equipment. The recovery system was being remodeled at the time, and the situation was further aggravated by an inventory in progress. The inventory required disassembly, cleaning, reassembly, and leak testing of certain pieces of equipment, particularly several long, 5-in.-diameter pipes used to store aqueous solutions of  $^{235}\text{U}$ . The spacing and dimensions of the pipes were such that contained solutions could not become critical. The inventory procedure required several days, and operations had been reestablished in the area immediately ahead of that in which the accident occurred.

As a consequence of the overlapping operations and of irregularities in the operation of some valves, a quantity of enriched uranium solution was inadvertently transferred from the area already returned to operation into the one undergoing leak testing. The flow pattern from the storage pipes into a drum intended to receive water that had been used for leak testing was such that the accumulated solution preceded the water (Fig. 1). Because of its size, the 22-in.-diameter, 55-gal drum permitted the solution to become critical. Further flow of water increased the uncompensated reactivity\* for about 11 min, then decreased it. The solution became subcritical after about 20 min.

At the time the system became critical, the solution volume is thought to have been 56 L in a cylinder 23.45 cm high and 55.2 cm in diameter. The  $^{235}\text{U}$  mass at the time was 2.1 kg; 0.4 kg was added later, while water was further diluting the system. During the excursion a radiation detection instrument (boron-lined ionization chamber, amplifier, and recorder) was operating about 1400 ft from, and crosswind to, the accident location. The trace shows that the radiation intensity first drove the pen off the scale and about 15 s later drove it off the scale again. During the next 2.6 min, the trace oscillated an indeterminate number of times. It is possible that the oscillations were decreasing in amplitude, although it cannot be confirmed by examining the trace. The average high-intensity field was followed for 18 min by a slowly decreasing ramp, about five times background.

---

\*Uncompensated reactivity is the reactivity that would pertain to a fissile system if the state of the system were not altered by its power.

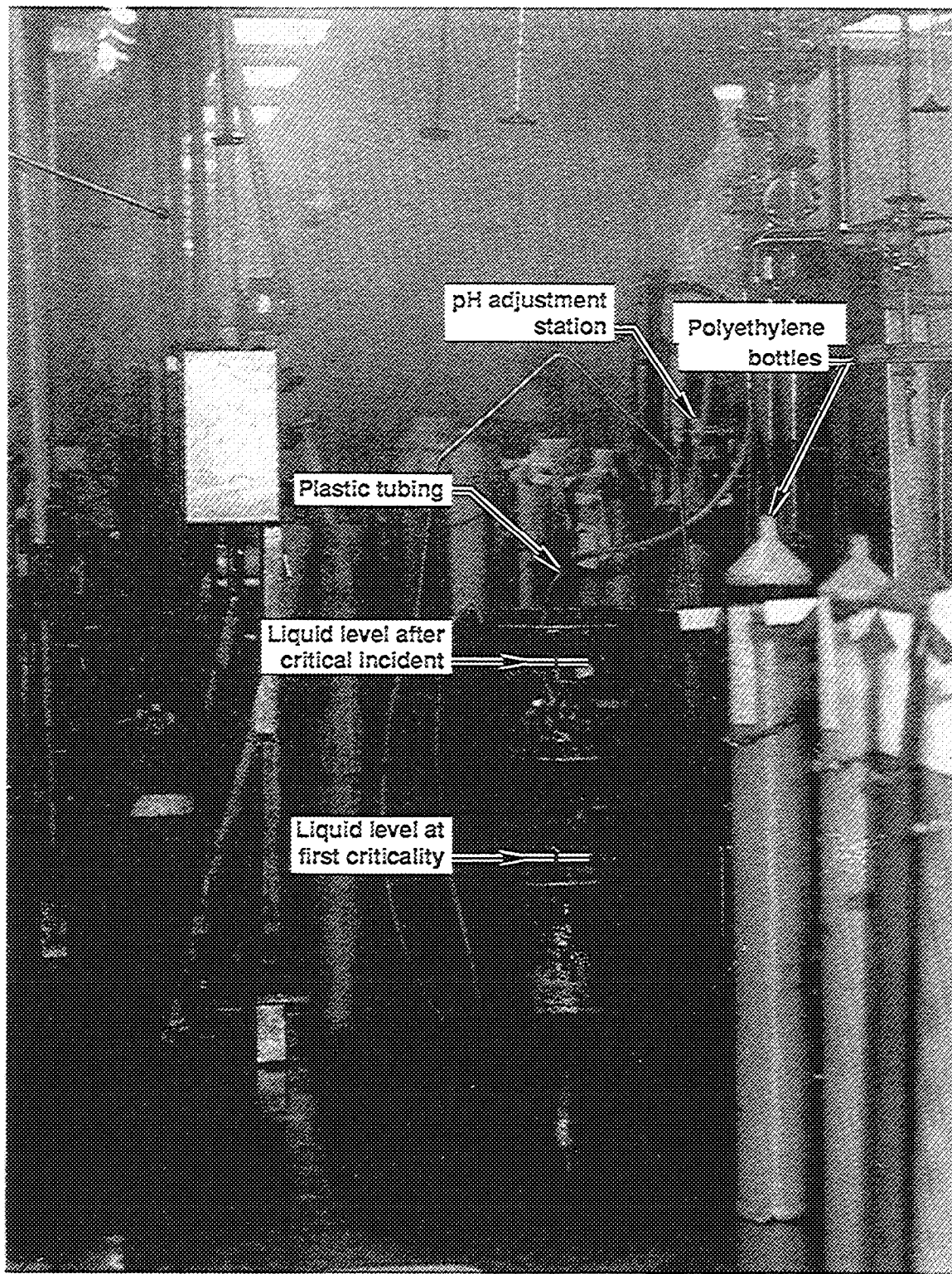

Fig. 1. 55-gal drum in which the 1958 Y-12 process accident occurred.

The power history can be reconstructed only qualitatively. The most likely source of initiation was neutrons from the reaction  $^{16}\text{O}(\alpha, n)^{19}\text{Ne}$  between  $^{234}\text{U}$  alpha particles and the oxygen in the water. Thus it is possible that the system reactivity slightly exceeded prompt criticality before the first excursion. The reactivity insertion rate was about 17  $\epsilon$ /s at the time,\* a relatively low value. The size of the first spike must have been determined by the reactivity attained when the chain reaction started. Although there is no way to be certain, a reasonable guess is that the first spike contributed about  $10^{16}$  fissions of the total yield of  $1.3 \times 10^{18}$  fissions. The second oscillation, or spike (which also drove the recording pen off the scale), occurred in 15 s, a quite reasonable time for existing bubbles to have left the system. The oscillations for the next 2.6 min appear to have been no greater than about 1.7 times the average power.

The power trace suggests that most of the fissions occurred in the first 2.8 min, in which case the average power required to account for the observed yield is about 220 kW. After this, the system probably started to boil, causing a sharp decrease in density and reactivity and reducing the power to a low value for the final 18 min.

During this incident,  $1.3 \times 10^{18}$  fissions occurred. There was no damage or contamination. Eight people received radiation doses (461, 428, 413, 341, 298, 86.5, 86.5, and 28.8 rem). At least one person owes his life to the fact that prompt and orderly evacuation plans were followed. One person survived 14-1/2 years; one 17-1/2 years; the status of one is unknown; and five were alive 29 years after the accident.

This accidental excursion was promptly simulated at the Oak Ridge National Laboratory (ORNL) to provide information about probable radiation exposures received by the people involved in the accident.

The plant was returned to operation within three days.

## I-2 Los Alamos Scientific Laboratory, Dec. 30, 1958<sup>5,6</sup>

*Separated phases in plutonium process tank, unshielded operation.*

The operations performed at the facility where the accident occurred were those chemical steps used to purify and concentrate plutonium from slag, crucible, and other lean residues that resulted from recovery processes. Typical and expected solutions contained less than 0.1 g Pu/L and traces of americium. An annual physical inventory was in progress at the time of the accident, thus normal flow into the area was interrupted so that residual materials in all process vessels could be evaluated for plutonium content. A reconstruction of significant events indicates that unexpected plutonium-rich solids, which should have been handled separately, were washed from two vessels into a single large vessel that contained dilute aqueous and organic solutions. After removing most of the aqueous solution from this vessel, the remaining approximately 200 L of material, including nitric acid wash, was transferred to the 850-L, 96-cm-diameter stainless steel tank in which the

---

\*1  $\epsilon$  = 1/100 \$, where \$ is the difference between delayed and prompt criticality.

accident occurred. The tank (Fig. 2) contained about 295 L of a caustic-stabilized aqueous-organic emulsion, and the added acid is believed to have separated the liquid phases.

The bottom layer (330 L) is thought to have contained 60 g Pu; the organic layer (160 L) contained 3.27 kg Pu (Fig. 3). Estimates indicate that this 20.3-cm-thick layer was perhaps 5 \$ below delayed criticality and that the critical thickness was 21 cm. When the motor drive of a stirrer was started, the initial action forced solution up the tank wall, displacing the outer portion of the upper layer and thickening the central region. The motion changed the system reactivity from about 5 \$ subcritical to super-prompt critical and a power excursion occurred. None of the gamma-sensitive recording meters within range of the accident showed a definitive trace; they did suggest, however, that there was a single spike. The excursion yield was  $1.5 \times 10^{17}$  fissions.

Based on postexcursion experiments in a similar geometry vessel, there was no apparent delay between start and full speed of the stirrer at 60 rpm (revolutions per minute). After 1 s (1 revolution), there was visible movement or disturbance on the surface, and in 2 or 3 s the system was in violent agitation. From these observations it can be concluded that the system could have been made critical in about 1 s; in no more than 2 or 3 s it must have been subcritical and the excursion was terminated.

From these time intervals and the estimate that initially the system was 5 \$ subcritical, the reactivity insertion rate would have been about 5 \$/s. This, with coefficients appropriate for the solution, leads to a spike yield of  $2.2 \times 10^{17}$  fissions with the spike completed in 1.65 s, that is, 0.45 s after prompt criticality was reached. To obtain the observed yield ( $1.5 \times 10^{17}$  fissions) in a single spike, the reactivity insertion rate would have to be reduced to about 2 \$/s. Because this is inconsistent with the time involved (about 3 s before complete mixing), the only alternative is to assume that the rate was somewhat less than 5 \$/s and that the excursion was terminated in about 3 s by the stirring action. One can surmise that the initial action was thickening of the upper layer, followed almost immediately by distortion into a less critical, vortex-like geometry by the action of the stirring blades.

The accident resulted in the death, 36 h later, of the operator who was looking into a sight glass when the motor was turned on. His radiation dosage was estimated to have been  $12,000 \pm 50\%$  rem. Two other persons apparently suffered no ill effects after receiving radiation doses of 134 and 53 rem. No equipment was contaminated or damaged even though the shock displaced the tank about 1 cm at its supports.

The entire plutonium process area had been reviewed by the Laboratory Nuclear Criticality Safety Committee about a month before the accident. Plans were underway to replace the large-volume process vessels with more favorable-geometry vessels. Administrative controls that had been used successfully for more than 7 years were considered acceptable for the additional 6 to 8 months that would be required to obtain and install the improved equipment.

Following the accident, procurement of favorable-geometry equipment was accelerated and installation was completed prior to restarting operations. To

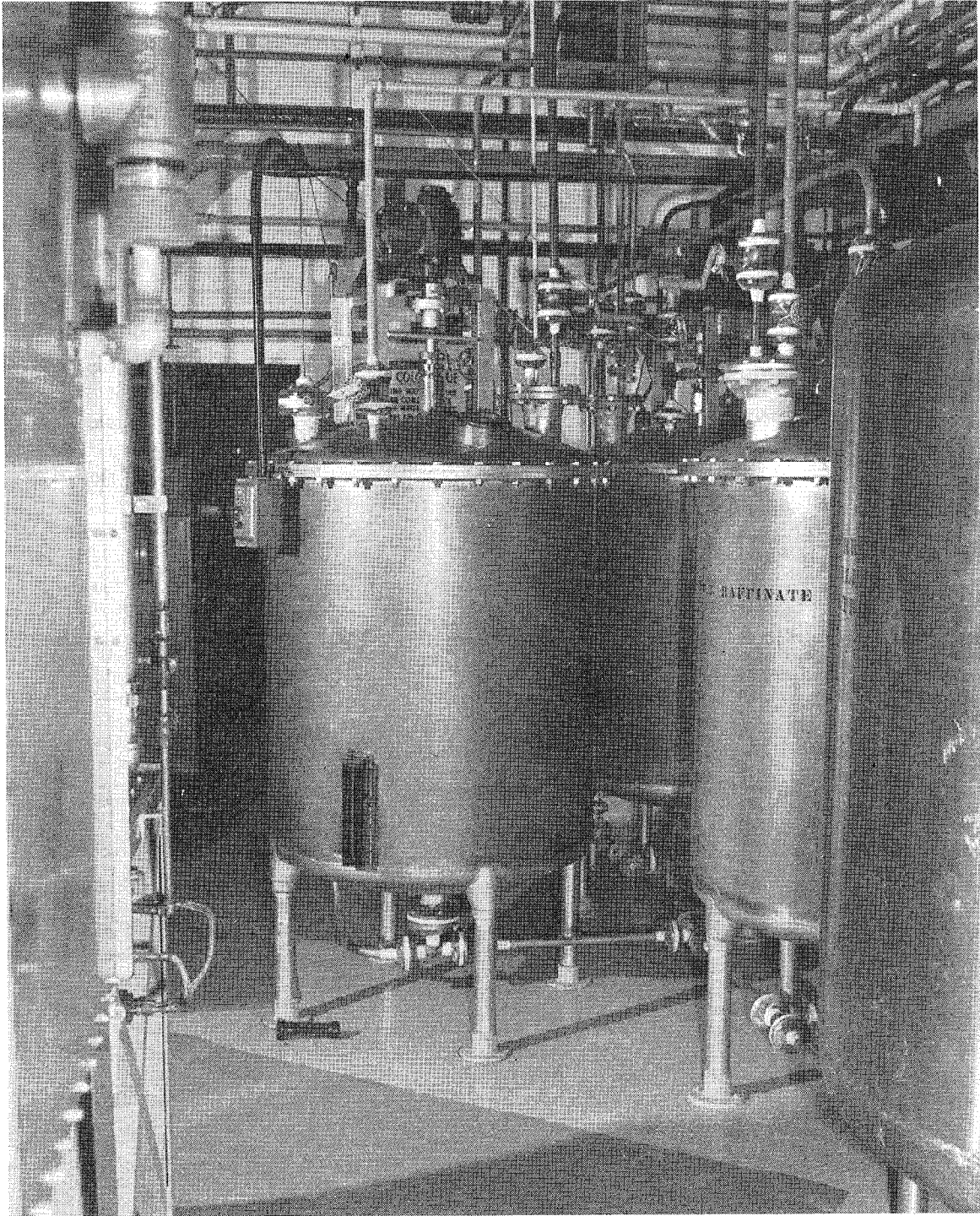

Fig. 2. Process vessel in which the 1958 Los Alamos plutonium solution accident occurred.

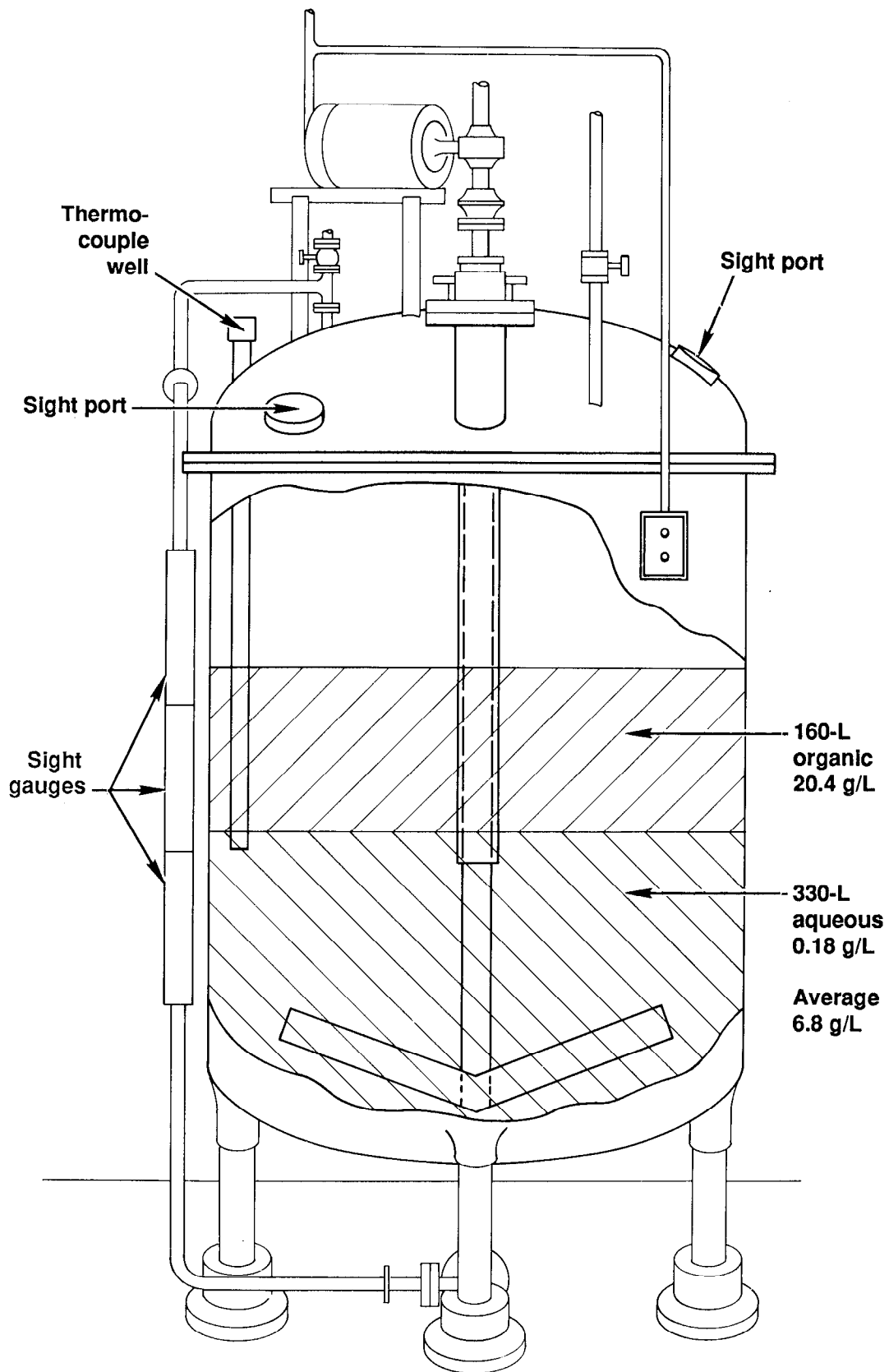

Fig. 3. Configuration of the 850 L plutonium solution tank prior to the accident.

provide enhanced safety, improved techniques for the sampling of solids were implemented and the importance of adherence to procedural controls was emphasized.

### **I-3 Idaho Chemical Processing Plant, Idaho Reactor Testing Area, Oct. 16, 1959<sup>7</sup>**

*Enriched uranium solution siphoned from a favorable- to a nonfavorable-geometry container, shielded operation.*

This incident occurred in a chemical processing plant that accepted, among other items, used fuel elements from various reactors. The active material (34 kg of enriched uranium, 93%  $^{235}\text{U}$  in the form of uranyl nitrate concentrated to about 170 g  $^{235}\text{U}/\text{L}$ ) was stored in a bank of containers with favorable geometry. The inadvertent initiation of a siphoning action during an air-sparging operation resulted in the transfer of about 200 L of the solution to a 5000-gal tank containing about 600 L of water. The resulting power excursion created  $4 \times 10^{19}$  fissions, sufficient to boil away nearly half of the 800-L solution volume.

The siphoning rate was 13 L/min, but the reactivity insertion rate depended on the degree of mixing; it could have been as high as 25  $\text{c}/\text{s}$ . Because the 9-ft-diameter tank was lying on its side, the solution configuration was a near-infinite slab. Waves in the solution could have caused large fluctuations in the system reactivity. After the incident, much of the uranyl nitrate was found to be crystallized on the inner walls of the tank and most of the water had evaporated.

The power history is a matter of conjecture—one can guess that it was similar to the Y-12 incident. It is not unreasonable to assume that an initial spike of at least  $10^{17}$  fissions was followed by power oscillations and, finally, by boiling for 15 to 20 min. The very large yield is a result of the large volume of the system and the long duration, rather than of the violence of the excursion. Because of thick shielding, none of the personnel received significant gamma or neutron doses. During evacuation of the building, airborne fission products resulted in beta dosages of 50 R (one person), 32 R (one person), and smaller amounts to 17 persons. Equipment involved in the excursion was not damaged.

### **I-4 Idaho Chemical Processing Plant, Idaho Reactor Testing Area, Jan. 25, 1961<sup>8</sup>**

*Uranium process solution transferred from a favorable- to a nonfavorable-geometry container, shielded operation.*

This incident is thought to have been caused by a bubble of high-pressure air (residuum from an earlier line unplugging operation) forcing about 40 L of 200 g  $^{235}\text{U}/\text{L}$  uranyl nitrate solution up a 5-in.-diameter pipe and into a 2-ft-diameter, 4-ft-high vapor-disengagement cylinder. The excursion occurred in the cylinder, probably as a single power spike because the geometry change must have been a fast transient. The yield was  $6 \times 10^{17}$  fissions; no estimates are available for the reactivity and power history.

The portion of the plant involved in the accident had been idle for about 12 months prior to the run. Two pumps pertinent to the operation were, at best, working poorly, and a line may have been plugged. Apparently the bubble of air was caused by efforts to correct these problems.



In this incident, irradiations were trivial because the process cell provided extensive shielding. The solution was contained, and plant operations were resumed within an hour.

#### **I-5 Hanford Works, Richland, Wash., April 7, 1962<sup>9,10,11</sup>**

##### *Plutonium solution incorrectly siphoned.*

This Recuplex system process plant accident involved cleaning up the floor of a solvent extraction hood, a product receiver tank that could overflow into the hood, a temporary line running from the hood floor to a transfer tank (about 18 in. diameter, 69 L capacity), and the apparent improper operation of valves.

The final triggering mechanism cannot be determined because the testimony of witnesses and operators is not in full agreement with the technical findings of the investigating committee. Although other mechanisms cannot be ruled out, there is a plausible (and simplified) course of events. The receiver tank overflowed into the hood, leaving a solution containing about 45 g Pu/L on the floor and in the sump; the operator, contrary to orders, opened the valve that allowed the solution to be lifted to the transfer tank; and the later addition of aqueous solution (10 to 30 L at 0.118 g Pu/L) and additional moderation following mixing and/or deaeration of the contents of the transfer tank led to the excursion.

The total excursion yield in the transfer tank was  $8 \times 10^{17}$  fissions, with the initial power spike estimated to be no more than  $10^{16}$  fissions. Following the spike, the tank was supercritical for 37-1/2 h as the power steadily decreased.

Activation of the building criticality alarm resulted in prompt evacuation. At the time (a Saturday morning), 22 people were in the building, only 3 received significant exposure to radiation (110, 43, and 19 rem). The incident itself caused no damage or contamination but did precipitate final shutdown of the plant. The Recuplex operation had been designed as a pilot plant and only later converted to production. A new plant had been authorized before the accident occurred.

Response to the incident was unique. A small, remotely controlled television-equipped robot was used to reconnoiter the building interior, fix precisely the point of the incident (through an attached, highly directional gamma probe), read meters, deposit instrumentation at specified locations, and operate valves on command.

Clayton<sup>10</sup> has suggested an interesting shutdown mechanism for this reaction. A central pipe that entered the bottom of the vessel in which the reaction occurred was found to contain dibutyl phosphate with a significant loading of plutonium. It is suggested that this started as a layer of tributyl phosphate in carbon tetrachloride on top of the aqueous plutonium solution that served as a reflector and was necessary to achieve criticality. The heat and radiation from the fission reaction could have driven off the  $\text{CCl}_4$  and converted the remaining organic largely to dibutyl phosphate. The heavier dibutyl phosphate, having taken up plutonium, could have gone to the bottom of the vessel and into the pipe, where it would contribute little to the system reactivity. As is often the case after an accident, it is difficult to evaluate the validity of this suggestion, but it does appear to provide a consistent explanation.

## I-6 Wood River Junction, R. I., Scrap Recovery Plant, July 24, 1964<sup>12,13</sup>

*Concentrated uranyl nitrate solution hand-poured into a nonfavorable-geometry container, two power excursions.*

This chemical processing plant accident occurred in the <sup>235</sup>U scrap recovery facility. The plant was designed to recover highly enriched uranium from unirradiated scrap material left from the fabrication of reactor fuel elements. Typical of the difficulties that should be expected with a new operation, an unexpectedly large amount of uranium-contaminated trichloroethane (TCE) solution had accumulated. The very low concentration of uranium in the solution was recovered by mixing the TCE with sodium carbonate solution. Prior to July 17, the operation was performed by hand in small bottles of favorable dimension (5-in.-diameter, 11-L volume). On that date, because of the large amount of solution, the operation was shifted to a sodium carbonate makeup tank approximately 18 in. in diameter and 25 in. deep—not a favorable geometry for concentrated solutions, which, however, were not expected in the area.

On the day before the accident, a plant evaporator had failed to operate properly and a plug of uranium nitrate crystals was found in a connecting line. The crystals were dissolved with steam, and the resulting concentrated solution (240 g <sup>235</sup>U/L) was drained into polyethylene bottles identical to those that normally held the very-low-concentration TCE solution. A bottle of the concentrated solution was mistaken for the TCE solution, and the operator poured it into a makeup tank that contained 41 L of sodium carbonate solution being agitated by an electric stirrer. The critical state was reached, and a reaction occurred when nearly all of the uranium had been transferred. The excursion (1.0 to  $1.1 \times 10^{17}$  fissions) created a flash of light, splashed about 1/5 of the solution out of the makeup tank, and knocked the operator to the floor. He was able to regain his footing and run from the area to an emergency building some 200 yards distant. The radiation dose he received was estimated to have been 10,000 rad. He died 49 h later.

An hour and a half after the excursion, two men entered the area to drain the solution into safe containers. To accomplish this, they turned off the stirrer as they left. The change in geometry created as the stirrer-induced vortex relaxed apparently added enough reactivity to create a second excursion, or possibly a series of small excursions. The estimated yield of the second excursion was 2 to  $3 \times 10^{16}$  fissions; no solution was splashed from the tank. That the second excursion had occurred was not realized until much later because the alarm was still sounding for the first event.

The two men involved in the second excursion received radiation doses, apparently while they were departing, estimated at between 60 and 100 rads. Other persons in the plant received very minor doses. No physical damage was done to the system, although cleanup of the splashed solution was necessary. The total energy release was equivalent to  $1.30 \pm 0.25 \times 10^{17}$  fissions.

**I-7 Windscale Works, Great Britain, Aug. 24, 1970<sup>14,15</sup>**

*A solvent-extraction plutonium recovery plant.*

This criticality incident, the smallest known to have occurred in any process area, is one of the more interesting and complex because of the intricate sequence of configurations that characterized it. The plant was used to recover plutonium from miscellaneous scrap, and the processes used were thought to be subject to very effective controls. Recovery operations started with a dissolver charge of about 300 g Pu. Following dissolution, the supernatant was transferred through a filter to a conditioner tank where the concentration was adjusted to between 6 and 7 g Pu/L, less than the minimum critical concentration.

The solution was vacuum-lifted from the conditioner to a transfer tank (Fig. 4). When the transfer was completed, the vacuum was broken and the transfer tank was allowed to drain into a constant-volume feeder that supplied a favorable-geometry, pulsed, solvent-extraction column. The connection from the transfer tank to the constant-volume feeder was through a 25-ft-deep trap, or lute, that prevented any potential backflow and thus controlled contamination.

The excursion occurred on completion of the transfer of a 50-L batch of solution from the conditioner to the transfer tank. The small size ( $10^{15}$  fissions) and brief duration (<10 s) of the excursion precluded the activation of any energy-based shutdown mechanism. Radiation measurements indicated the excursion occurred in the transfer tank, but the solution from the conditioner was too lean to sustain criticality and the total quantity of plutonium in the batch (300 g) was about 60% of the minimum critical mass. Thus, it was feared that the transfer tank might contain large quantities of solids, perhaps tens of kilograms and that any disturbance of the system might stimulate another, possibly much larger, excursion.

A 6-in.-diameter hole was cut through the concrete roof, and the vacuum line to the transfer tank was opened. The interior of the transfer tank was inspected with a fiber-optics system (developed specifically for this recovery operation) and was found to contain liquid. A small-diameter plastic line was inserted into the tank and 2-1/2 L aliquots were siphoned to a collection point in an adjacent building. Inspection of the liquid revealed tributyl phosphate and kerosene with a specific gravity of 0.96 g/mL and containing 55 g Pu/L. Aqueous liquor from the conditioner had a specific gravity of 1.3. A 25-ft column of aqueous liquor in one arm of the trap was sufficient to balance approximately 33.8 ft of solvent in the other arm. Thus any solvent introduced into the transfer tank was held in the arm and could accumulate until the volume of solvent corresponded to a height of 33.8 ft above the bottom of the trap. Some 39 L, containing about 2.15 kg Pu, were present. Degradation of the solvent indicated it had been trapped in the transfer tank for several months, and perhaps for as long as two years.

Each time a batch of aqueous liquor was processed through the transfer tank, the solvent would strip some plutonium from the aqueous liquor. With each transfer, the plutonium concentration in the tributyl phosphate and kerosene increased. The operation that resulted in the excursion probably added about 30 g Pu to the solvent. Periodic plant cleanout by flushing nitric acid through the system presumably reduced the plutonium concentration in the trapped solvent. Thus the

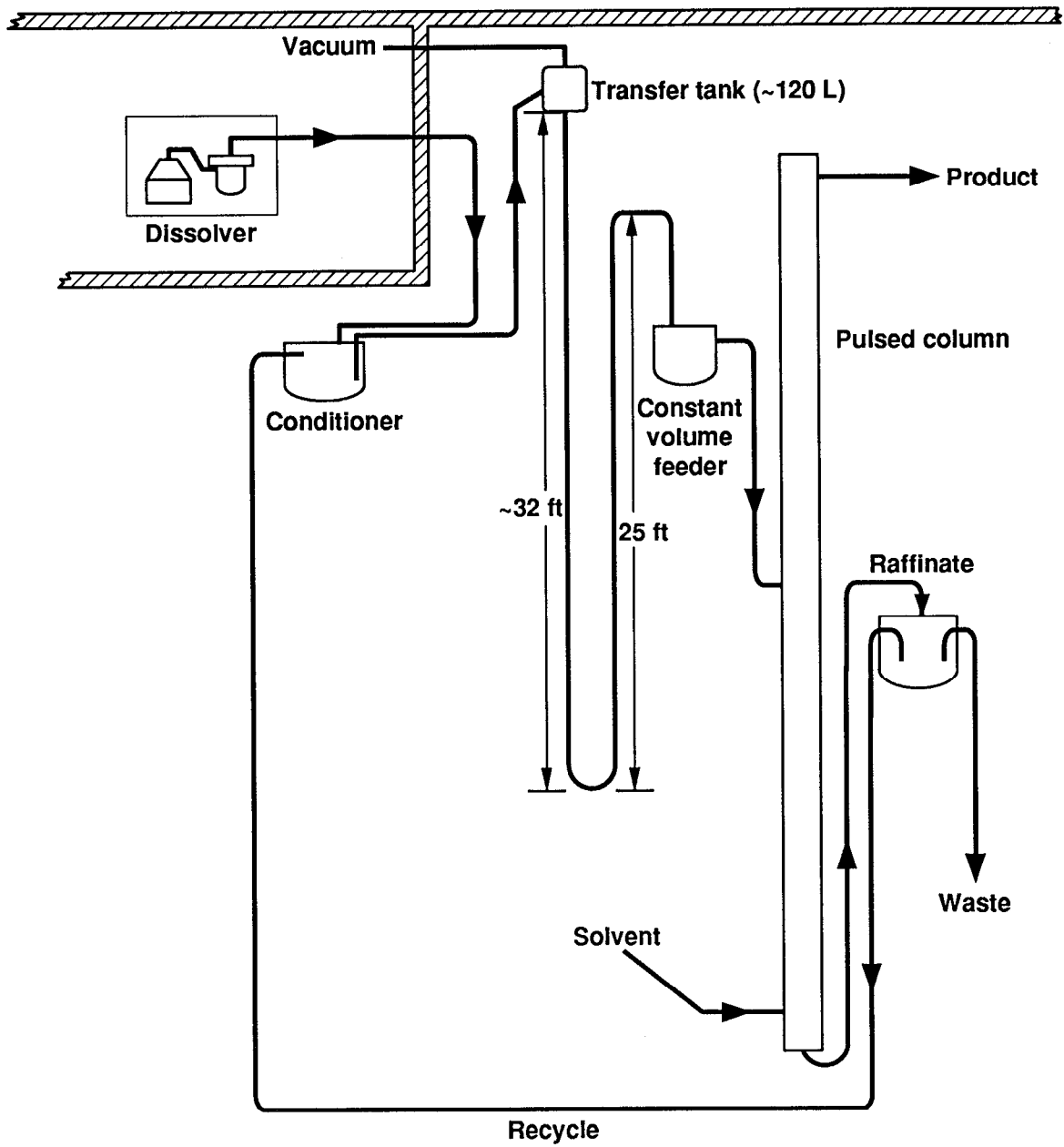

Fig. 4. The British Nuclear Fuels, Ltd., process line at Windscale.

concentration may have slowly increased, then been abruptly reduced. Several such cycles could have been repeated before the system achieved criticality. The actual shutdown mechanism remains in question because the rate of drainage of the transfer tank was not sufficient to account for the brief duration of the excursion.

A transparent plastic mockup of the transfer tank was used to observe the configuration of the liquids during transfer. The situation existing during the transfer is shown in Fig. 5a. Rich organic (55 g/L) is floating on top of lean aqueous liquor (6 to 7 g/L). The aqueous stream pouring into the center of the tank provides a region of low reactivity. Between the organic and aqueous is a region of mixed phases, about 3 in. thick near the axis of the tank. This configuration is subcritical.

Just after completion of the transfer (Fig. 5b) the central plug of aqueous liquor has disappeared, the region of mixed phases is still present, and the configuration has a maximum value of the multiplication factor. Separation of the two phases occurs within a few seconds of completing the transfer (Fig. 5c). Monte Carlo calculations have indicated that the reactivity of Fig. 5b is about 5 \$ greater than that of Fig. 5a and about 10 to 15 \$ greater than Fig. 5c.

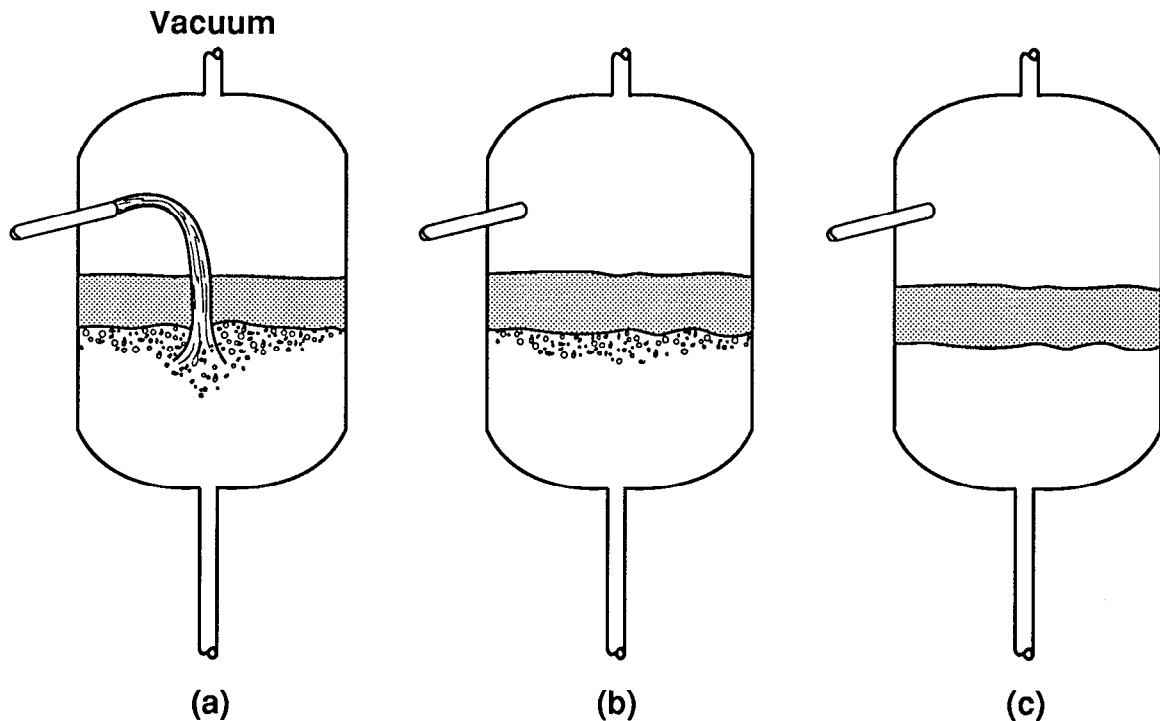

Fig. 5. Solution transfer in the Windscale process line.

Apparently, there was sufficient time between nitric acid washes for the plutonium concentration to increase until the system became slightly supercritical at the conclusion of a transfer, tripping the criticality alarms.

Two people were in the plant at the time of the accident. One received an estimated exposure of 2 rads, the other less than 1 rad.

This excursion illustrates the subtle ways in which accidents can occur during solution processing. Although the deep trap was considered a safety feature for the control of contamination, it contributed directly to the criticality accident. The difficulty of understanding what had happened, even after it was known in which tank the fission process occurred, is an excellent example of the impracticability inherent in attempting to calculate criticality accident probabilities for specific processes.

### **I-8 Idaho Chemical Processing Plant, Oct. 17, 1978**

#### *Solvent-extraction process, enriched uranium.*

The accident occurred in a shielded cell of a fuel reprocessing plant in which solutions from the dissolution of irradiated reactor fuel were processed by solvent extraction to remove fission products and recover the enriched uranium.

In the solvent extraction process, immiscible aqueous and organic streams counterflow with intimate contact and, through control of acidity, a material of interest is transferred from one stream to the other. In this operation, the aqueous recovery solution, containing less than 1 g enriched U/L, was fed into the top of the column; less dense organic (a mixture of tributyl phosphate and kerosene) was fed into the bottom of the column (Fig. 6). A string of perforated plates along the axis of the column was driven up and down to form a "pulsed column" and to increase the effectiveness of contact between the two streams. As the streams passed through the pulsed column, uranium was stripped from the aqueous stream by the organic. The large-diameter regions at the top and bottom of the column are disengagement sections where the aqueous and organic streams separate more completely (Fig. 7). The aqueous waste stream (raffinate) from the bottom of column 1A was sampled to verify compliance with discard limits before being sent to waste storage tanks. The organic product stream (containing about 1 g U/L) from the top of column 1A was fed into stage two at the bottom of the pulsed scrubbing column, H-100 (1B).

In the second stage (1B) the organic product was contacted by a clean aqueous stream fed into the top of H-100 to scrub out residual fission products. The aqueous stream was buffered with aluminum nitrate to a concentration of 0.75M to prevent significant transfer of uranium from the organic stream to the aqueous stream. In normal operation, some uranium would be taken up by the aqueous, to a concentration of about 0.15 g/L, so the aqueous output of column 1B was fed back and blended with the dissolver product going into column 1A. The organic product stream from 1B, normally about 0.9 g U/L, went on to stage three (1C), where the uranium was stripped from the organic by 0.005M nitric acid. The output of the stripping column then went to mixer settlers where additional purification took place. Still further downstream, the uranium solution went to an evaporator where it was concentrated to permit efficient recovery of the uranium.

Several factors contributed to this accident. An evaporator had plugged, and operations had been suspended for several weeks while instrumentation difficulties were corrected. During the downtime, a valve leaked water into the aluminum nitrate makeup (PM-106) tank used for preparation of the aqueous feed to the scrubbing stage (1B). This leak, over time, caused a dilution of the feed solution from 0.75M to 0.08M. The 13,400-L makeup tank was equipped with a density gauge

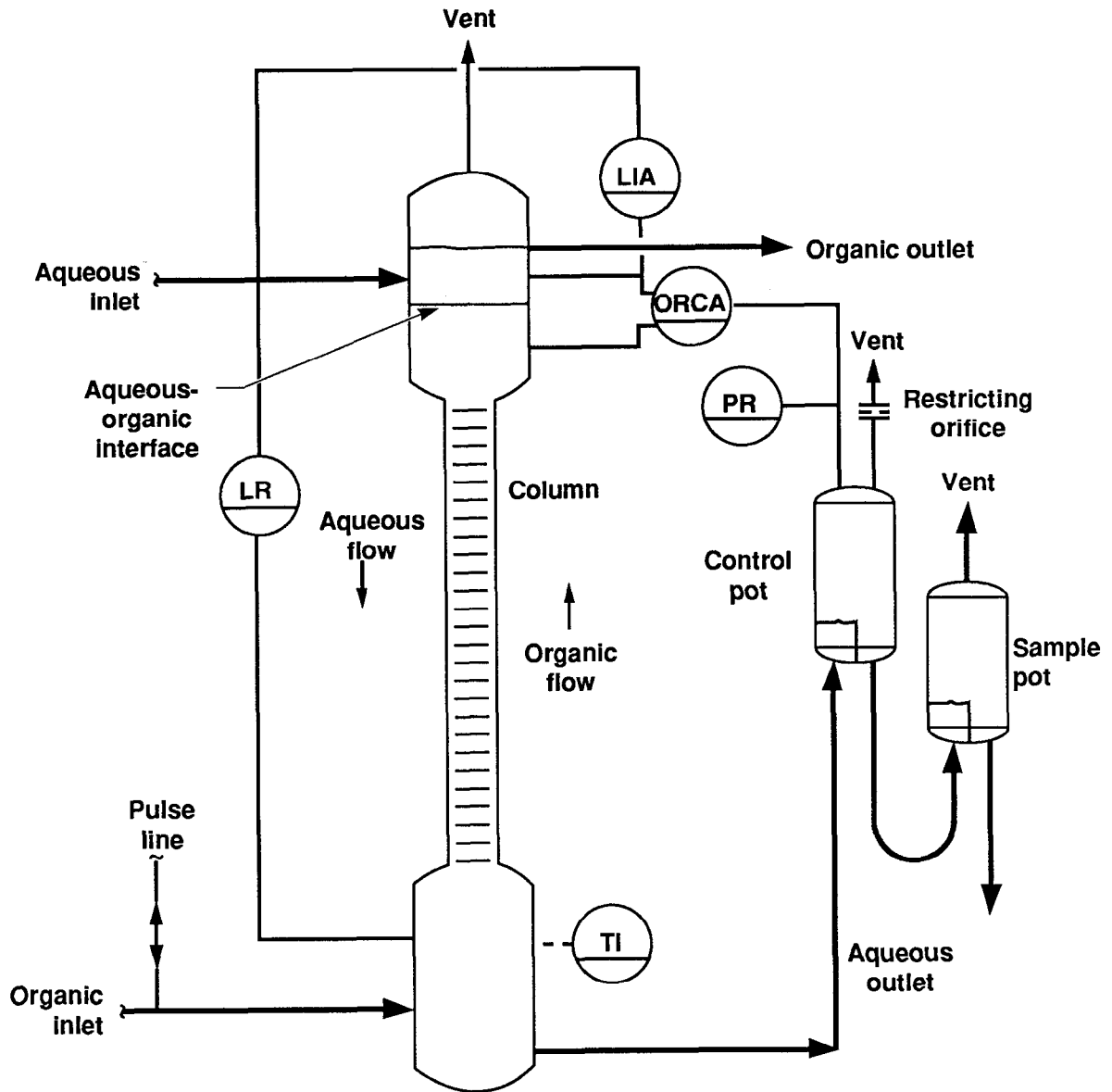

Fig. 6. H-100 Scrub Column.

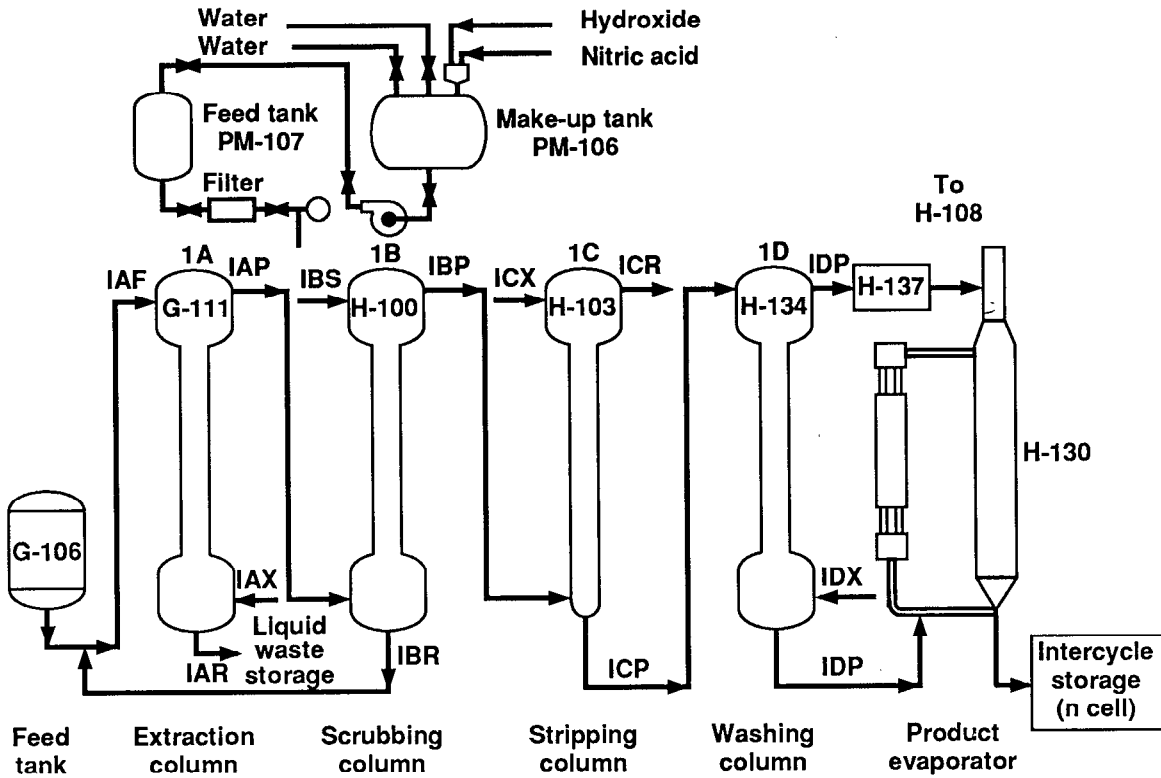

Fig. 7. First-cycle extraction line, Idaho Chemical Processing Plant.

that would have indicated the discrepancy, but the gauge was inoperable. A density gauge was scheduled to be installed on the 3,000-L process feed (PM-107) tank that was filled, as necessary, from the makeup tank, but this had not been done. The makeup tank was instrumented with a strip-chart recorder showing the solution level in the tank, but the leak into the tank was so slow that the change in level was not discernible without pulling out several days of the chart length. Procedures required that the density in the process feed tank be obtained after each transfer from the makeup tank. Results of sample analyses were not available until after the accident.

The out-of-specification aqueous feed to the scrubbing column caused it to operate as a stripper rather than as a scrubber. Some of the enriched uranium was removed from the column 1B organic and recycled into the input of column 1A. This partially-closed loop resulted in a steady increase in the uranium inventory in the two columns. Each time diluted solution was added to the feed tank from the makeup tank, the aluminum nitrate concentration in the feed was further reduced and stripping became more effective until the excursion occurred.

Analyses of the aqueous feed for column 1B (feed tank PM-107-0) showed the proper concentration of 0.7M aluminum nitrate on September 15, 1978. Samples taken on September 27 and October 18 (the day after the accident) had concentrations of 0.47M and 0.084M, respectively. Concentrations of aluminum nitrate less than



0.5M are insufficient to prevent some stripping of uranium from the organic, and the final concentration would result in almost all of the uranium being stripped from the organic.

The process feed tank (PM-107-0) was filled with aluminum nitrate solution from the makeup tank (PM-106-0) at about 6:30 p.m., October 17. Approximately an hour and a half later, the process operator was having difficulty controlling pulsed column H-100 (1B). During his efforts to maintain proper operation, he reduced the pressure on the control pot, thus permitting increased aqueous flow from H-100 back to G-111 (1A). At approximately 8:40 p.m. a radiation alarm activated, probably because of fission products in the plant stack gasses. Shortly after the alarm, several other alarms activated and the stack monitor gave a full-scale reading. The shift supervisor and the health physicist went outside the building and detected radiation intensities up to 100 mrem/h. At 9:03 p.m. the shift supervisor ordered the building evacuated, and by 9:06 an orderly evacuation had been completed. Appropriate road blocks were established and management was properly notified.

In the evacuation, the process operator shut off all feed to the first-cycle extraction process, but did not stop the pulsation of the columns.

The reaction clearly took place in the lower section of H-100, with most of the fissions occurring in the upper portion of the section. Records indicate the reaction rate increased very slowly until late in the sequence, when a sharp rise in power occurred. The uranium inventory in column H-100 was estimated to have been about 10 kg, compared with slightly less than 1 kg during normal operation. The total number of fissions during the reaction was estimated to be  $2.7 \times 10^{18}$ , or an energy release of about 165 MJ. The average power during the approximately one-half hour of the reaction was then a little less than 100 kW.

It is probable that, as the uranium inventory in the bottom of H-100 increased because of the lean aluminum nitrate scrub solution, the system achieved the delayed-critical state, then became slightly super-critical and the increasing power raised the temperature to compensate for the presence of additional uranium. This process would continue as long as the uranium addition was slow and until the reduced pressure on the control pot permitted more rapid addition of uranium and a sharp increase in reactivity. The system is thought to have approached prompt criticality, at which time the rate of power increase would have been determined by the neutron lifetime that would be on the order of milliseconds. The continuation of the pulse action after the feed was turned off probably led to improved mixing of the solution in the bottom section of H-100 and terminated the reaction.

There was no significant personnel exposure and no damage to process equipment. As a direct result of this event, the plant suffered an extended and expensive shutdown; all operating procedures were reviewed in detail and revised as appropriate. Increased emphasis was given to plant maintenance and operator training. An extensive and highly instrumented plant protection system involving redundant sensors and redundant, automatic safety controls was installed.

The importance of maintenance of safety-related equipment and the need for adherence to well-developed operating procedures were reemphasized by this accident.

## II. REACTOR AND CRITICAL EXPERIMENT ACCIDENTS

### A. FISSILE SOLUTION SYSTEMS

#### II-A.1 Los Alamos Scientific Laboratory, Dec. 1949<sup>16,17</sup>

*Water-boiler reactor, control rods removed by hand.*

This incident occurred while two new control rods (poisons) were being tested in the water-boiler reactor. The water boiler was a 12-in.-diameter stainless-steel sphere containing 13.6 L of a water solution of uranyl nitrate. In 1949 it was reflected by thick graphite.

The rods had been installed, and the operator was manually checking their dropping times. After several tests of each individual rod, a safe procedure because one rod was sufficient to maintain subcriticality, both rods were pulled, held for about 5 s and then dropped simultaneously. A short time later the rods were again pulled and dropped together.

The removal of the two rods increased the reactivity to about 3  $\epsilon$  over prompt criticality, corresponding to a period of 0.16 s. The power probably rose with this period to a very broad peak of 2 or 3  $\times 10^{16}$  fissions/s and remained close to this value for about 1-1/2 s. The excursion was not immediately detected because all of the instrumentation was turned off, except for a direct-reading thermometer that showed a temperature rise of 25°C, equivalent to a yield of 3 or 4  $\times 10^{16}$  fissions.

The operator received 2.5 R of gamma radiation. The reactor was not damaged.

#### II-A.2 Hanford Works, Richland, Wash., Nov. 16, 1951<sup>18</sup>

*Plutonium solution assembly, cadmium rod removed too rapidly, remote control.*

The critical assembly in which the excursion occurred was an aqueous solution of 1.15 kg Pu in the form of plutonium nitrate contained in an unreflected 20-in.-diameter aluminum sphere. The purpose of the experimental program was to determine the critical mass of plutonium for various container geometries and solution concentrations. The excursion occurred during the approach to criticality, when the sphere was 93% full, as a result of withdrawing a remotely controlled hollow cadmium safety rod in a series of steps with insufficient time between steps. The excursion yield was 8  $\times 10^{16}$  fissions, and a small amount of fuel was forced through gaskets at the top of the reactor assembly. Because the gaskets sealed about 18 L of air above the fuel level prior to the incident, pressures considerably in excess of atmospheric must have existed in the assembly during the accident.

The published data suggest that the reactivity insertion rate resulting from the safety rod withdrawal must have been about 4.7  $\$/s$ , which would lead to a fission yield of about twice the observed value if known temperatures and void coefficients of reactivity are used. In this case, however, the action of the scram circuit was sufficiently fast that the cadmium rod most probably contributed to the shutdown of the excursion. A slight reduction in the assumed reactivity insertion

rate would lengthen the time, making it even more certain that the excursion was stopped by the falling poison rod.

No personnel were injured in this excursion, although plutonium nitrate solution contaminated the experimental area. The building was successfully decontaminated in a few days, but before cleanup of the test area was completed, a fire occurred and the building was abandoned.

### **II-A.3 Oak Ridge National Laboratory, May 26, 1954<sup>19</sup>**

*Uranium solution assembly, central poison cylinder tilted from proper position, shielded and remote operation.*

The experiment was one of a series in which the critical properties of aqueous solutions in annular cylindrical containers were being investigated. The outer cylinder had a diameter of 10 in.; a cadmium-clad inner cylinder was 2 in. in diameter. The system was unreflected and consisted of 55.4 L of a water solution of  $\text{UO}_2\text{F}_2$  that contained 18.3 kg of enriched (93%  $^{235}\text{U}$ ) uranium. The excursion occurred while the liquid level was at 40 in. and more solution was being added slowly to approach a delayed critical configuration. The experimental situation before and after the accident is illustrated in Fig. 8. The inner cylinder was essentially a poison rod. When it became detached from its connection at the top and tipped to the side of the outer container, it fell to a less effective position, thus allowing the system reactivity to rise well over prompt criticality and causing a power excursion of  $10^{17}$  fissions.

The reconstruction of this incident was most thorough. The tilting of the inner cylinder added reactivity to the system at a rate corresponding to 3.33  $\$/s$ , which continued well into the prompt critical region. Using known coefficients and generation times, an initial power spike of  $5.1 \times 10^{16}$  fissions can be calculated. Since development of the power spike would require only about 0.07 s after the system reached prompt criticality (0.43 s after the cylinder began to tip), the cylinder was still tilting. It is characteristic of such incidents that after an initial spike, the power is such as to balance the reactivity insertion rate. For this solution, the required power was a few megawatts and it must have been fairly constant until the inner cylinder reached its maximum displacement 0.91 s after inception of the transient. At this time the power dropped sharply and, when the liquid began to drain, the system became far subcritical.

Because of thick shielding, no one received a radiation dose greater than 0.9 rem. Only a few tens of cubic centimeters of solution were displaced from the cylinder; the area was returned to normal experimental use in 3 days.

### **II-A.4 Oak Ridge National Laboratory, Feb. 1, 1956<sup>19</sup>**

*Uranium solution assembly, wave motion created by falling cadmium sheet, shielded and remote operation.*

In this experiment certain reactor parameters were being investigated by measuring stable reactor periods. The system was a 76-cm-diameter cylindrical tank filled to a depth of 13 cm with 58.9 L of aqueous solution containing 27.7 kg of  $^{235}\text{U}$  as the compound  $\text{UO}_2\text{F}_2$ . Transfer of solution from storage to the test cylinder was

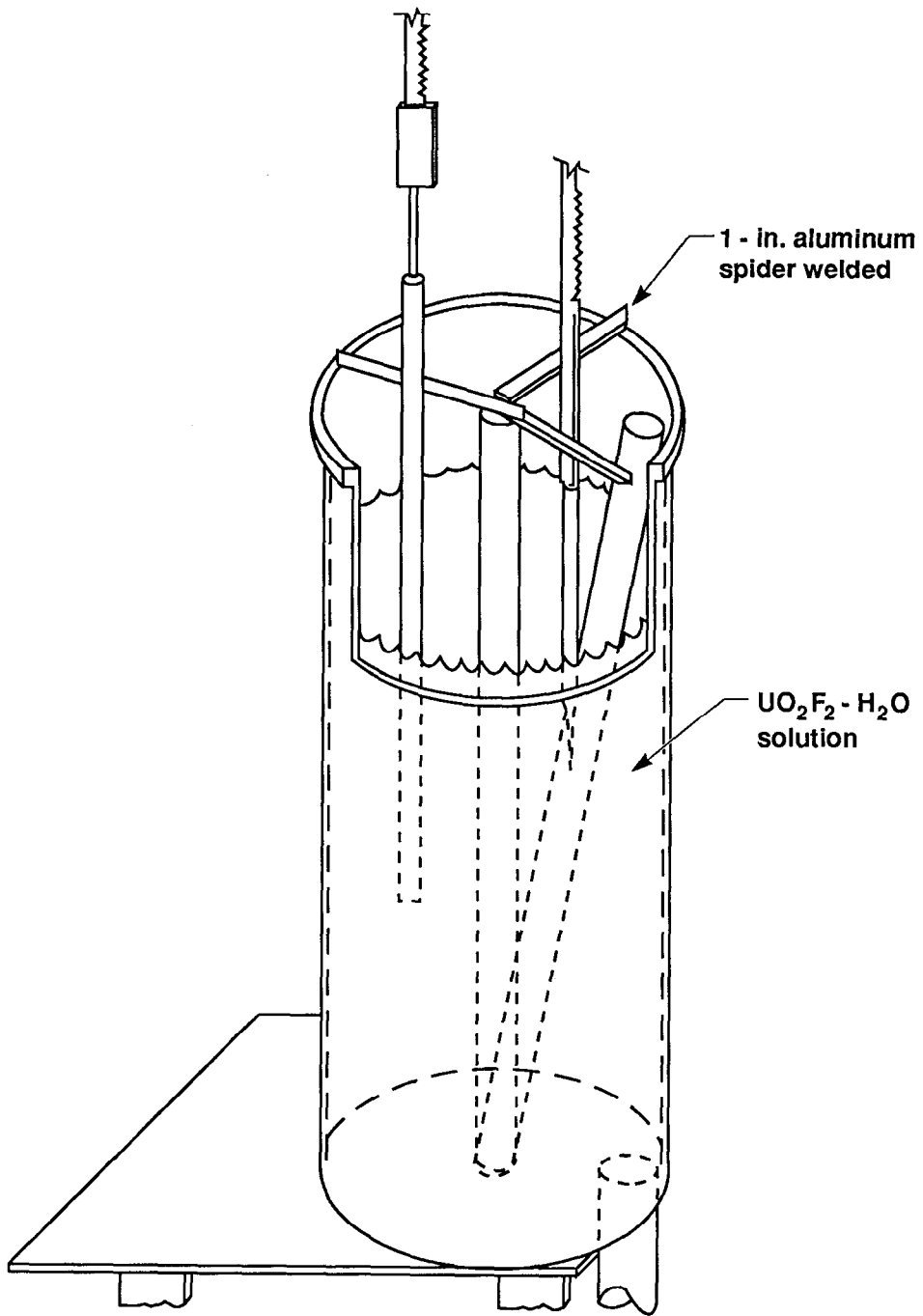

Fig. 8. The ORNL uranium solution assembly showing the normal and detached positions of the central poison rod.

achieved by applying air pressure to the storage vessel; flow was controlled by a remotely operated valve in a 1/2-in.-diameter line. With the control switch in the "feed" position, the valve was open and air pressure was applied; with the switch in the "drain" position, the valve was also open, but the air supply was turned off and the storage vessels were vented to the atmosphere. When the switch was in the intermediate "neutral" position, the valve was closed and the storage vessels were vented.

The situation was one in which the solution volume was about 100 mL less than the critical volume. An increment of solution was added, and the transient period decreased rapidly to approximately 30 s, where it seemed to remain constant. Shortly thereafter the fuel control switch was placed in the drain position and the period meter indicated a rapid decrease in period so that the safety devices were actuated almost simultaneously by both manual and instrument signal; the instrument trip point had been set at a 10-s period. Immediately thereafter the excursion occurred. The yield was  $1.6 \times 10^{17}$  fissions and, in this case, a "considerable volume" of solution was forcibly ejected from the cylinder. Postexcursion tests showed that if insufficient time were allowed for venting the operating pressure, addition of solution to the reactor could have continued for several seconds after the control switch was placed in the drain position. This addition of solution accounted for the decrease in period that precipitated the scram, but the increment of solution could not have added enough reactivity to account for the excursion.

The reactivity of such shallow, large-diameter assemblies is very sensitive to the solution depth but quite insensitive to changes in the diameter. For this system, the estimated difference between delayed criticality and prompt criticality is only 1 mm of depth. If the effective diameter were reduced to 50 cm, the depth would have to be increased only 12 mm to maintain delayed criticality. It is thought that the falling scram, a cadmium sheet slightly deformed at the bottom, set up a wave system that must have converged at least once and created a super-prompt critical geometry.

In this case the analysis was directed to finding what reactivity insertion rate would cause a power spike of the required yield. The analysis was then examined to see if it contradicted any known facts. It was found that a rate of 94  $\$/s$  was adequate to cause a spike of 8 ms duration, which would account for the observed yield. The maximum excess reactivity would be about 2  $\$$  over prompt criticality; the void volume could be 12 times that of the ORNL May 26, 1954 accident (II-A. 3), thus easily accounting for the splashing of the solution. The void volume that results as microbubbles (caused by disassociation of water by fission fragments) coalesce is discussed in *III. Power Excursions and Quenching Mechanisms*.

A laborious chemical decontamination of the assembly room was required to clean up the ejected solution. Slight mechanical damage was evidenced by distortion of the bottom of the cylinder. No one received a radiation dose greater than 0.6 rem.

## II-A.5 Oak Ridge National Laboratory, Jan. 30, 1968<sup>20</sup>

*<sup>233</sup>U solution sphere, reactivity added by air bubble movement.*

Routine critical experiments were underway to determine the critical concentration of an aqueous solution of uranyl nitrate in a thin aluminum sphere (5.84-L volume) with a thick water reflector. The uranium contained 97.6% <sup>233</sup>U to a concentration of 167 g/L. The solution density was 1.23 kg/L.

The solution height in the sphere could be adjusted through the vertical motion of an external 55-mm-diameter cylindrical tank. This adjustment tank was connected to the sphere by a 13-mm-diameter flexible line. The system had achieved criticality, and measurements were being taken to determine incremental reactivity values. Lowering of the adjustment tank did not provide the expected reduction in reactivity. An air bubble was visually observed in the line connecting the adjustment tank to the sphere. In an attempt to remove the bubble, enough solution was drained to the supply reservoir to achieve subcriticality. The adjustment tank was then moved up and down in an effort to dislodge the bubble. The motion was repeated at least twice. At a time when no adjustments were knowingly being made, the reactivity increased rapidly, all shutdown devices functioned, and the radiation alarm sounded.

It is assumed that motion of the air bubble caused the addition of enough solution to the sphere to change the system from subcritical to essentially prompt critical. The yield of the excursion was determined to have been  $1.1 \times 10^{16}$  fissions. Approximately 90 mL of solution was expelled from the tank into the water reflector and onto the nearby floor and equipment. The modest cleanup required was accomplished promptly.

Simple modification of the experimental configuration precluded future introductions of air bubbles.

## B. BARE AND REFLECTED METAL ASSEMBLIES

### II-B.1 Los Alamos, New Mexico, Aug. 21, 1945<sup>16,21</sup>

*Plutonium core reflected with tungsten carbide, hand assembly.*

### II-B.2 Los Alamos, New Mexico, May 21, 1946<sup>16,21</sup>

*Plutonium core reflected with beryllium, hand assembly.*

Two accidental excursions occurred with the same core and were, in several respects, quite similar. The core consisted of two hemispheres of delta-phase plutonium coated with 5 mil of nickel. The total core mass was 6.2 kg; the density was about 15.7 g/cm<sup>3</sup>

In the first accident, a critical assembly was being created by hand stacking 4.4 kg tungsten-carbide bricks around the plutonium core. Figure 9 shows a reenactment\* of the configuration with about half of the tungsten blocks in place.

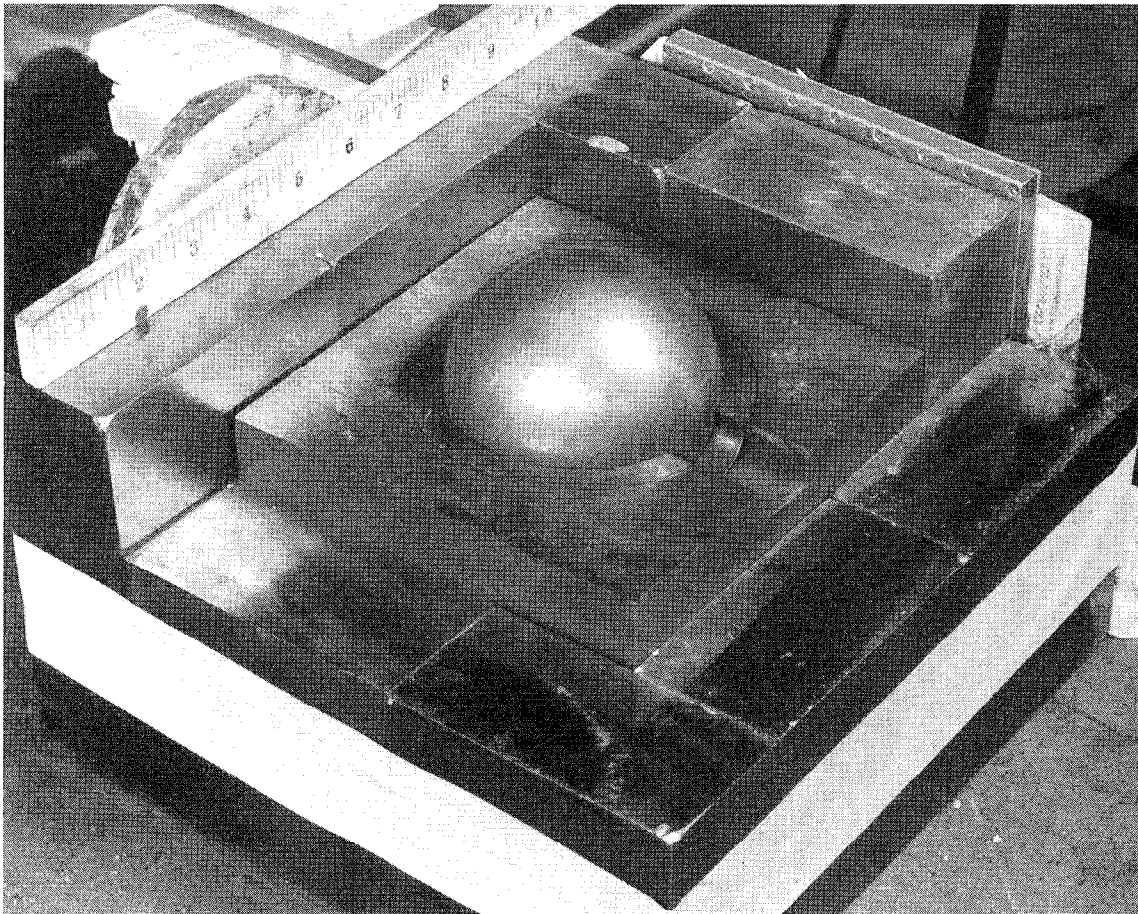

Fig. 9. Plutonium sphere partially reflected by tungsten-carbide blocks.

---

\*The Los Alamos National Laboratory archives include some data and comments about a "rerun" October 2, 1945, to determine the radiation dose received in the incident of August 21, 1945. The yield of the rerun was about  $6 \times 10^{15}$  fissions, but the prompt critical state was not reached. The maximum reactivity of the system during this experiment was about 60 ¢ above delayed criticality.

The lone experimenter was moving the final brick over the assembly for a total reflector of 236 kg when he noticed, from the nearby neutron counters, that the addition of this brick would make the assembly supercritical. As he withdrew his hand, the brick slipped and fell onto the center of the assembly, adding sufficient reflection to make the system super-prompt critical. A power excursion occurred. He quickly pushed off the final brick and proceeded to unstack the assembly. His exposure was estimated as 510 rem from a yield of  $10^{16}$  fissions. He died 28 days later.

An Army guard assigned to the building, but not helping with the experiment, received a radiation dose of approximately 50 rem. The nickel canning on the plutonium core did not rupture.

In the second accident, the techniques involved in creating a metal critical assembly were being demonstrated to several people. The system consisted of the same plutonium sphere reflected, in this case, by beryllium. The top and final hemispherical beryllium shell was being slowly lowered into place; one edge was touching the lower beryllium hemisphere while the edge  $180^\circ$  away was resting on the tip of a screwdriver (Fig. 10). The person conducting the demonstration was holding the top shell with his left thumb placed in an opening at the polar point, while slowly working the screwdriver out with his right hand when the screwdriver slipped and the shell seated on the lower hemisphere. An excursion occurred at once, the shell was thrown to the floor, and all personnel left the room.

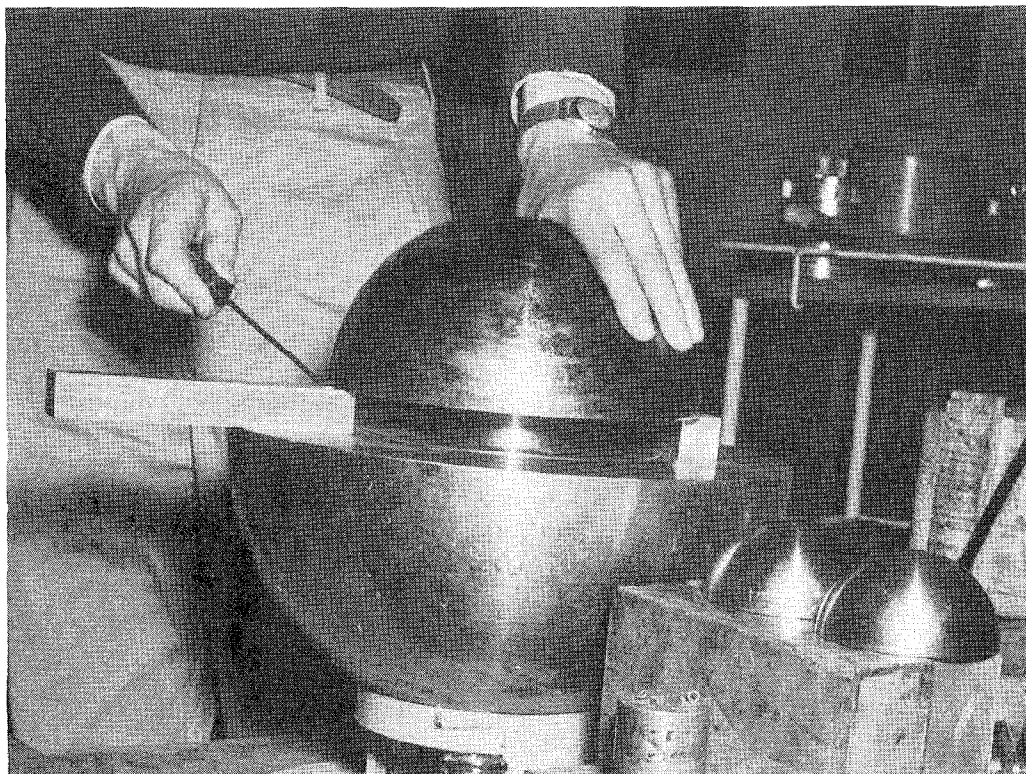

Fig. 10. Configuration of beryllium reflector shells prior to the accident May 21, 1946.



The yield of this excursion was  $3 \times 10^{15}$  fissions; again, there was no rupture of the nickel canning. The eight people in the room received doses of about 2100, 360, 250, 160, 110, 65, 47, and 37 rem. The man who performed the experiment died 9 days later.

The results of calculations of the fission rate in this sphere, as a function of time for several values of excess reactivity, are shown in Fig. 11. Fig. 12 represents the total number of fissions to be expected as a function of time for the same excess reactivities.\* These data are applicable to both accidents because the difference in reflector material has only a small effect on the neutron kinetics. In the first excursion, if the excess reactivity did not exceed 0.15 \$, the assembly must have been together for several seconds, which is not unreasonable. In the second event, the experimenter was better prepared to disassemble the material, and it is thought that this was done in a fraction of a second, perhaps less than 1/2 s. The known parameters would then be satisfied by an excess reactivity of about 0.10 \$.

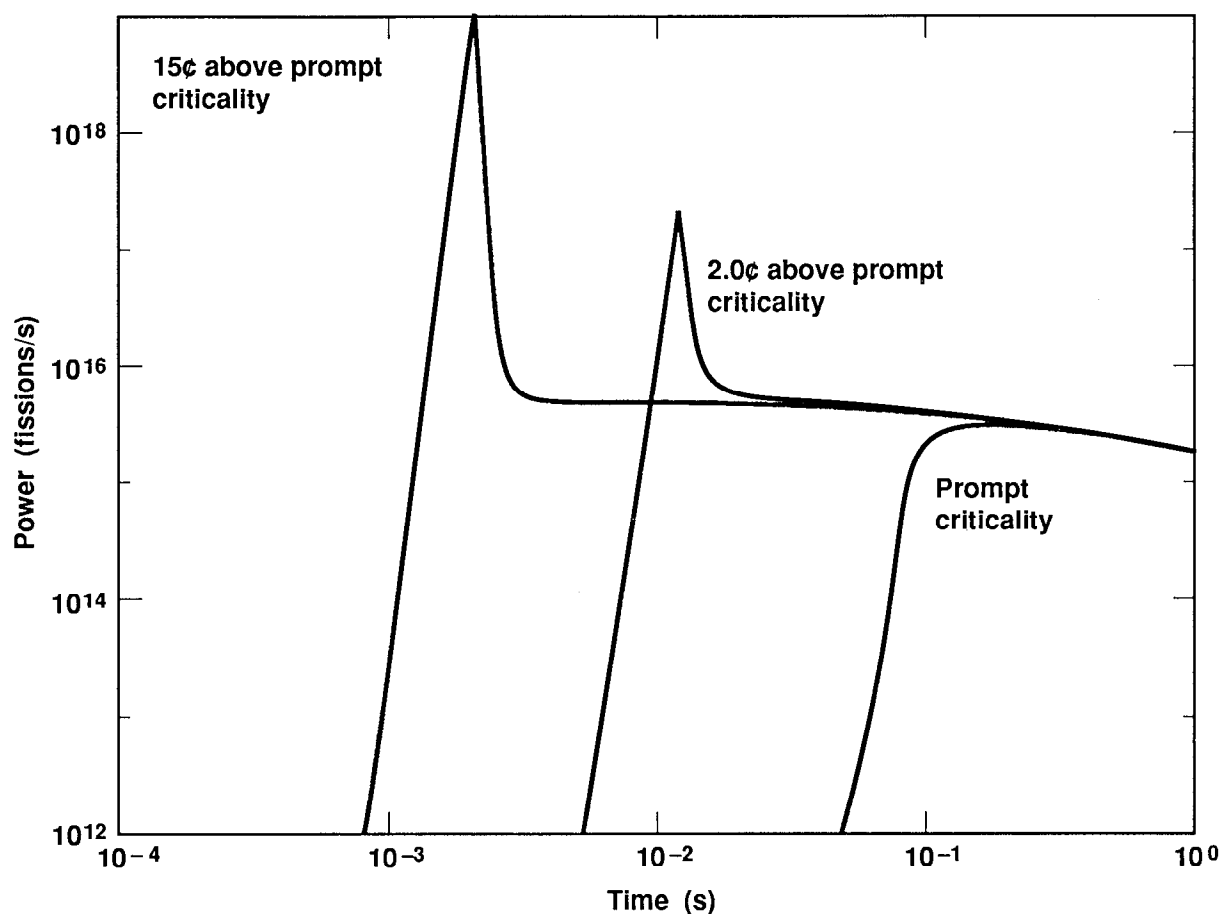

Fig. 11. Calculated fission rate for 6.2-kg plutonium sphere.

\*We are indebted to T. P. McLaughlin of the Los Alamos National Laboratory for these calculational results.

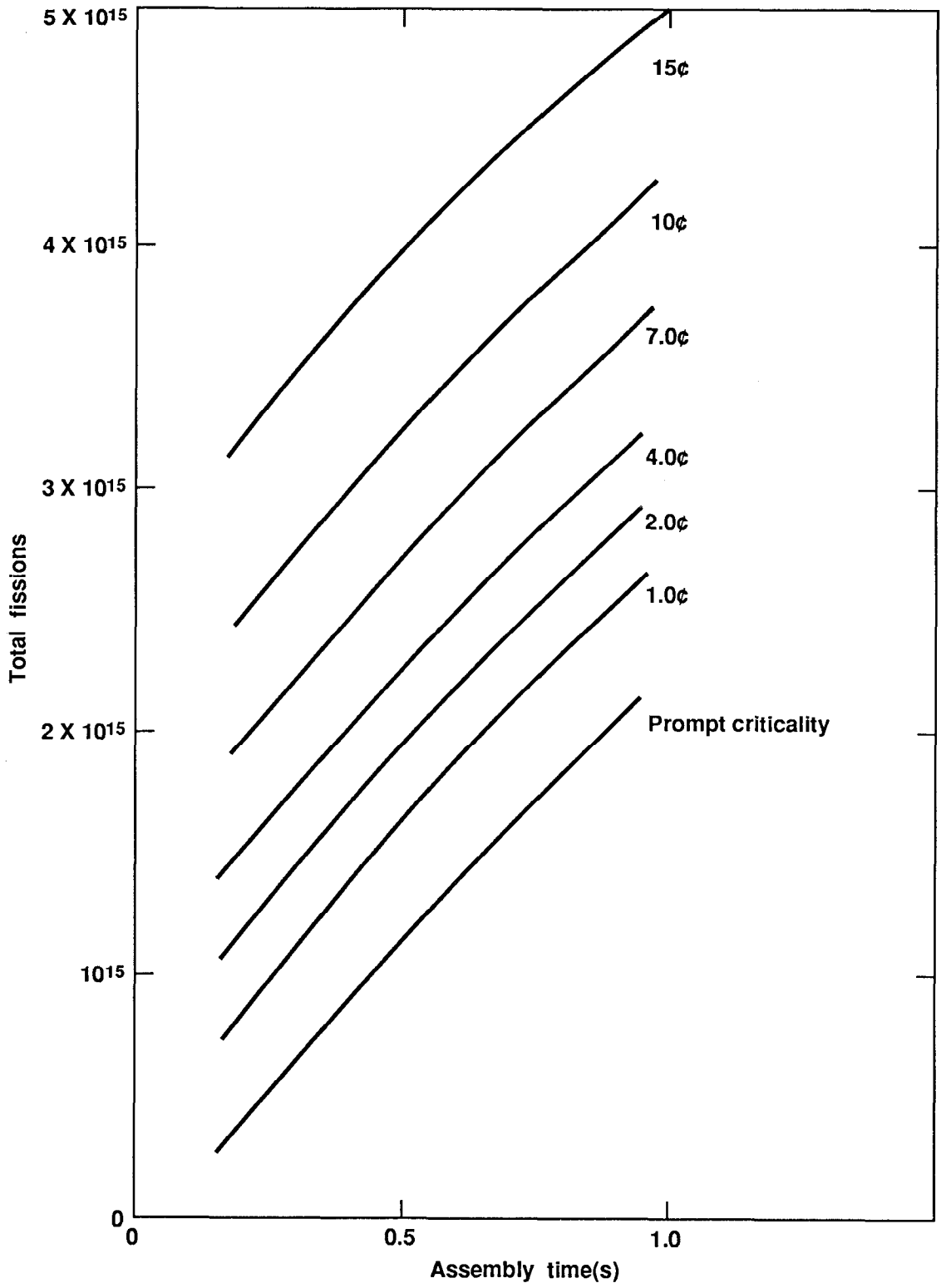

Fig. 12. Calculated total fissions vs time for the 6.2-kg plutonium sphere.

### II-B.3 Los Alamos Scientific Laboratory, Feb. 1, 1951<sup>21,22,23</sup>

*Critical separation experiment, two large  $^{235}\text{U}$  metal masses in water, control 1/4 mile away.*

A water-reflected system was set up in 1949 to obtain the neutron multiplication of a single unit of fissile metal in water. The system had two scram devices. The first, with a quick response, consisted of a pneumatic cylinder that raised the unit out of the water; the second, slower device, was the draining of the tank. Later, a traveling support was added so that critical separation distances between two units could be determined; a dropping cadmium screen provided an additional scram (Fig. 13).

The excursion was precipitated by an experiment that measured the critical separation distance of two enriched uranium masses (each of 93.5%  $^{235}\text{U}$ ) in water: one, a solid cylinder of 24.4 kg and the other, a hollow cylinder of 38.5 kg. Sheet cadmium 10 mil thick was fastened to the outer surface of the solid cylinder and to the inside surface of the hollow cylinder. A paraffin slug filled the cavity in the hollow cylinder.

At the completion of the critical separation experiment (at a multiplication\* of 65.5), the assembly was scrammed as a final flourish. The water started draining, the cadmium screen dropped, the solid cylinder (left-hand body in Fig. 13) was lifting, and an excursion (later determined to be  $10^{17}$  fissions) was made evident by jamming of neutron counters and the appearance on television of a vapor cloud above the water.

Later reconstruction of the accident showed that the pneumatic tangential scram was the first to be effective and led directly to two types of difficulty. First, the center of reactivity of the left-hand cylinder (Fig. 13) proved to be below that of the stationary cylinder and, second, the rapid lift through the water created Bernoulli forces that swung the cylinders closer together. The combination of the two effects was enough to drive the assembly prompt critical and to have maintained this or a greater reactivity for 0.2 s if the power excursion had not occurred. The first power spike is estimated to have contained  $6 \times 10^{15}$  fissions. It is possible that one or more excursions into the prompt region followed because boiling was the primary quenching mechanism.

In this excursion of  $10^{17}$  fissions, no radiation doses were received, and no contamination was found in the experimental area. Damage to the uranium consisted of a small amount of oxide flaking and blistering. The experimental area was in use two days later.

---

\*Multiplication is the ratio of the leakage neutron flux from the enriched assembly to the leakage flux from an identical natural uranium assembly, each containing the same neutron source. The reciprocal multiplication approaches zero as the system approaches criticality.

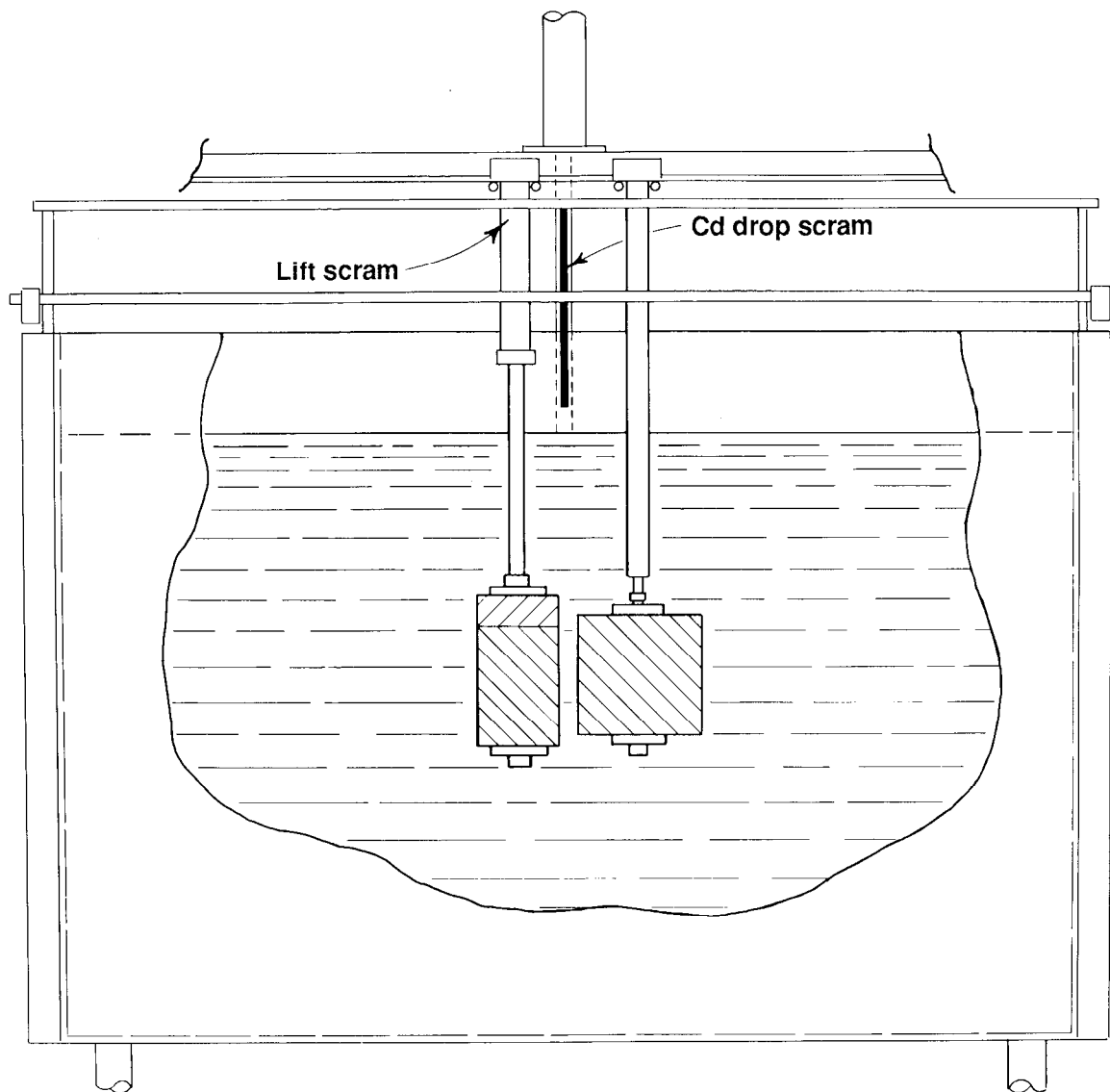

Fig. 13. The LASL aquarium assembly machine employed for measurements of critical separation distances.

#### II-B.4 Los Alamos Scientific Laboratory, April 18, 1952<sup>21,24</sup>

*Jemima, cylindrical, unreflected  $^{235}\text{U}$  metal assembly, control 1/4 mile away.*

The system in which the excursion took place was a cylindrical, unreflected, enriched 93%  $^{235}\text{U}$  metal assembly made up of a number of plates, each 26.7 cm in diameter and 0.8 cm thick.

Complete assembly of the two components had been made previously with six plates in the lower component, but with first three and then four plates in the upper component.

A plot of the reciprocal multiplication versus number of plates, or total uranium, shows clearly that the system should not have been assembled with 11 plates. Nevertheless, such an assembly was attempted following a computational error made independently by two people. Contrary to operating regulations, a graph of the data had not been plotted. The burst yield was  $1.5 \times 10^{16}$  fissions.

There is no way to determine the power history experienced by the 92.4-kg mass without reproducing the experiment. At the time the system was near prompt criticality, the lower component was coasting upward and probably inserting no more than 2 or 3  $\$/s$ , a rate that could cause a power spike of about  $10^{15}$  fissions. The power would then stabilize at about  $10^{17}$  fissions/s, just enough to compensate for the reactivity insertion rate. Most of the  $1.5 \times 10^{16}$  fissions must have occurred in this plateau. The power dropped essentially to zero when the automatic scram system separated the two masses of metal.

During the remotely controlled operation no damage was done to the system, even to the fissile material. None of the personnel received any radiation, and the experimental area was not contaminated. The apparent self-terminating property of this excursion stimulated study with Godiva-I,<sup>25,26,27</sup> which became a facility for generating large bursts of fission-spectrum neutrons in less than 100  $\mu s$ .

#### II-B.5 Los Alamos Scientific Laboratory, Feb. 3, 1954<sup>23,26</sup>

*Lady Godiva, bare  $^{235}\text{U}$  sphere, control rod misoperation, control 1/4 mile away.*

#### II-B.6 Los Alamos Scientific Laboratory, Feb. 12, 1957<sup>27,28,29</sup>

*Lady Godiva, bare  $^{235}\text{U}$  sphere, added reflection, control 1/4 mile away.*

These two excursions occurred in the Lady Godiva assembly, an unreflected metal reactor fabricated in three principal sections that, when assembled, formed a sphere. Figure 14 shows Godiva in the scrambled state. The central section was fixed in position by small tubular steel supports, while the upper and lower sections were retractable by means of pneumatic cylinders, thus providing two independent scram mechanisms. The critical mass was about 54 kg of uranium enriched to 93.7%  $^{235}\text{U}$ . It was operated remotely from a distance of 1/4 mile.

The first accidental excursion occurred during preparations for a scheduled prompt burst, part of a program to measure the parameters associated with excursions. Normally, a burst was initiated by establishing delayed criticality. This was accomplished by adjusting control rods, by lifting the top section to reduce reactivity and allow decay of the neutron population, and by lowering the top section into position and rapidly inserting a burst rod worth slightly more than 1  $\$$ .

A power excursion typically creating about  $10^{16}$  fissions in 100  $\mu s$  followed; in 40 ms the system would be scrambled safely. Because the only source of neutrons was spontaneous fission, it was customary to assemble to an excess reactivity of about 70  $\epsilon$  to generate sufficient neutrons to determine the settings for delayed criticality in a reasonable time. This accidental excursion was caused, apparently, because additional reactivity was inserted by error after assembly to 70  $\epsilon$ , but before a fission chain started.

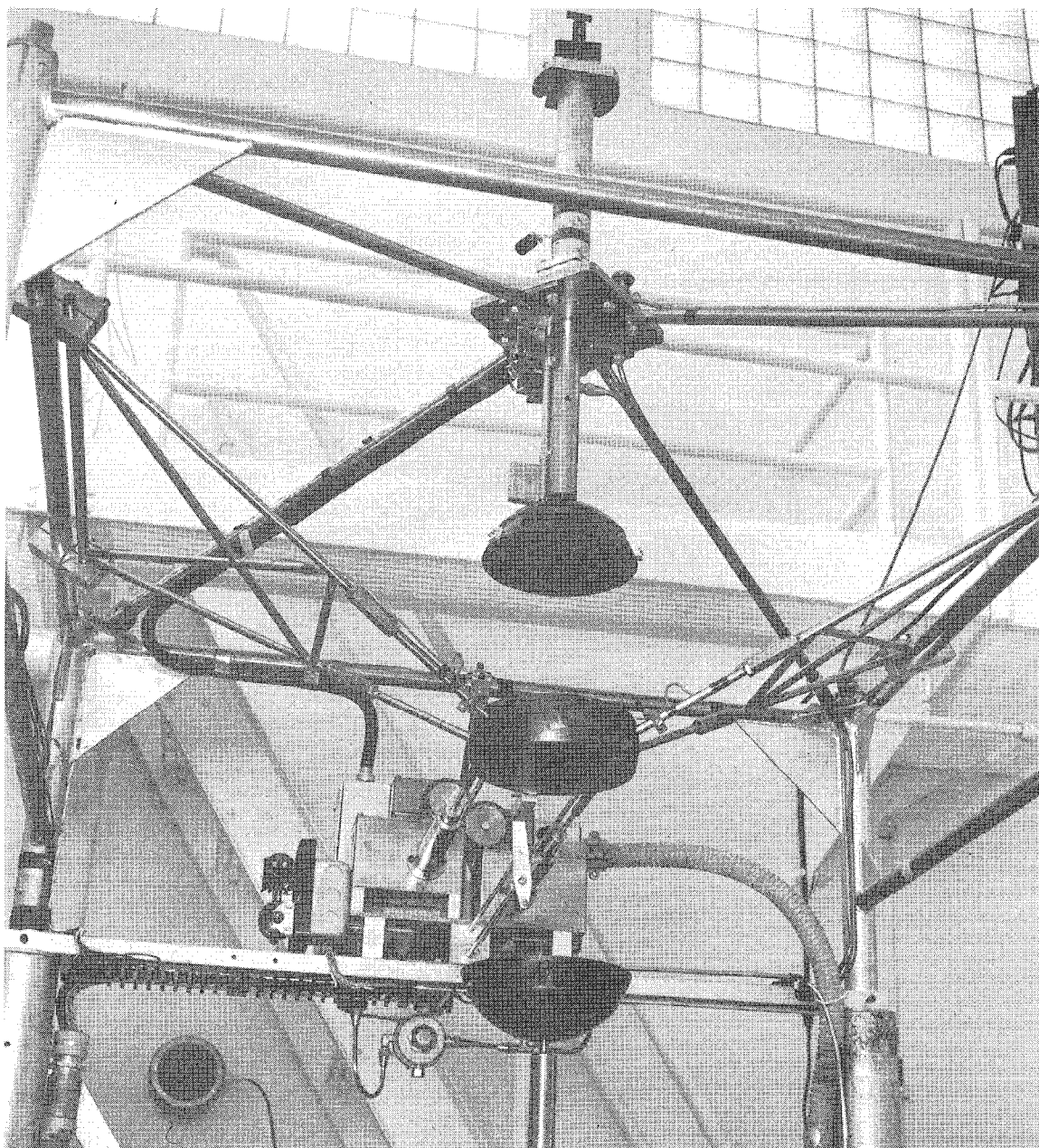

**Fig. 14. The LASL Lady Godiva assembly (unreflected enriched-uranium sphere) in the scammed configuration.**

The excursion yield was  $5.6 \times 10^{16}$  fissions, about six times the yield of the average burst. There was no radiation hazard, spreading of contamination, personnel radiation, or significant damage to the major uranium parts. One piece was slightly warped and required remachining. Several light steel supporting members were bent or broken (Fig. 15).

The second accidental excursion occurred during preparations for an experiment in which Godiva was to provide a pulse of fast neutrons. Again, the burst occurred during assembly to establish, in this case, a fiducial point at about 80 ¢ excess reactivity. Control rods were to be adjusted on the basis of this period. The extra reactivity is thought to have been contributed by a large mass of graphite and polyethylene that was to be irradiated. This mass had just been moved close to Godiva, and either the change in reflection was underestimated or the material slumped further toward Godiva.

The burst yield was  $1.2 \times 10^{17}$  fissions, about 12 times the standard excursion. The uranium metal was severely oxidized, had warped, and apparently had been plastic near the center. The central burst rod was nearly ruptured and, at its center, must have been within 100°C of the uranium melting temperature. Figure 16 shows several of the pieces. External damage was limited to the supporting structure; radioactive contamination consisted of oxide scale; cleanup proceeded rapidly. Repair of Lady Godiva was not practical; therefore construction of Godiva-II,<sup>30</sup> specifically designed for burst operation, was accelerated. Despite the severity of the excursion, operating personnel received no significant radiation because of the large distance between the reactor and the control room.

The behavior of the Godiva system during super-prompt critical power excursions is well understood both experimentally and theoretically.<sup>26,29,30</sup> Lady Godiva experienced well over 1000 safe, controlled bursts. A coupled hydrodynamics-neutronics code describes the behavior of the system adequately.

The first excursion ( $5.6 \times 10^{16}$  fissions) must have had a period of 6.4 s, equivalent to a reactivity excess over prompt criticality of 15 ¢. The excess reactivity of the larger excursion ( $1.2 \times 10^{17}$  fissions) was 21 ¢ above prompt criticality, corresponding to a period of 4.7 s.

The fission yield of  $1.2 \times 10^{17}$  in the second incident is equivalent to the energy contained in 1.7 lb of high explosive (HE), but the damage was much less than would have been caused by that quantity of HE. The above-mentioned code can predict the fraction of fission energy converted to kinetic energy; in this case, only about 1.4% of the energy, equivalent to 0.024 lb HE, was available as kinetic energy to do damage. The damage was consistent with this figure, and it is evident that most of the fission energy was deposited as heat.

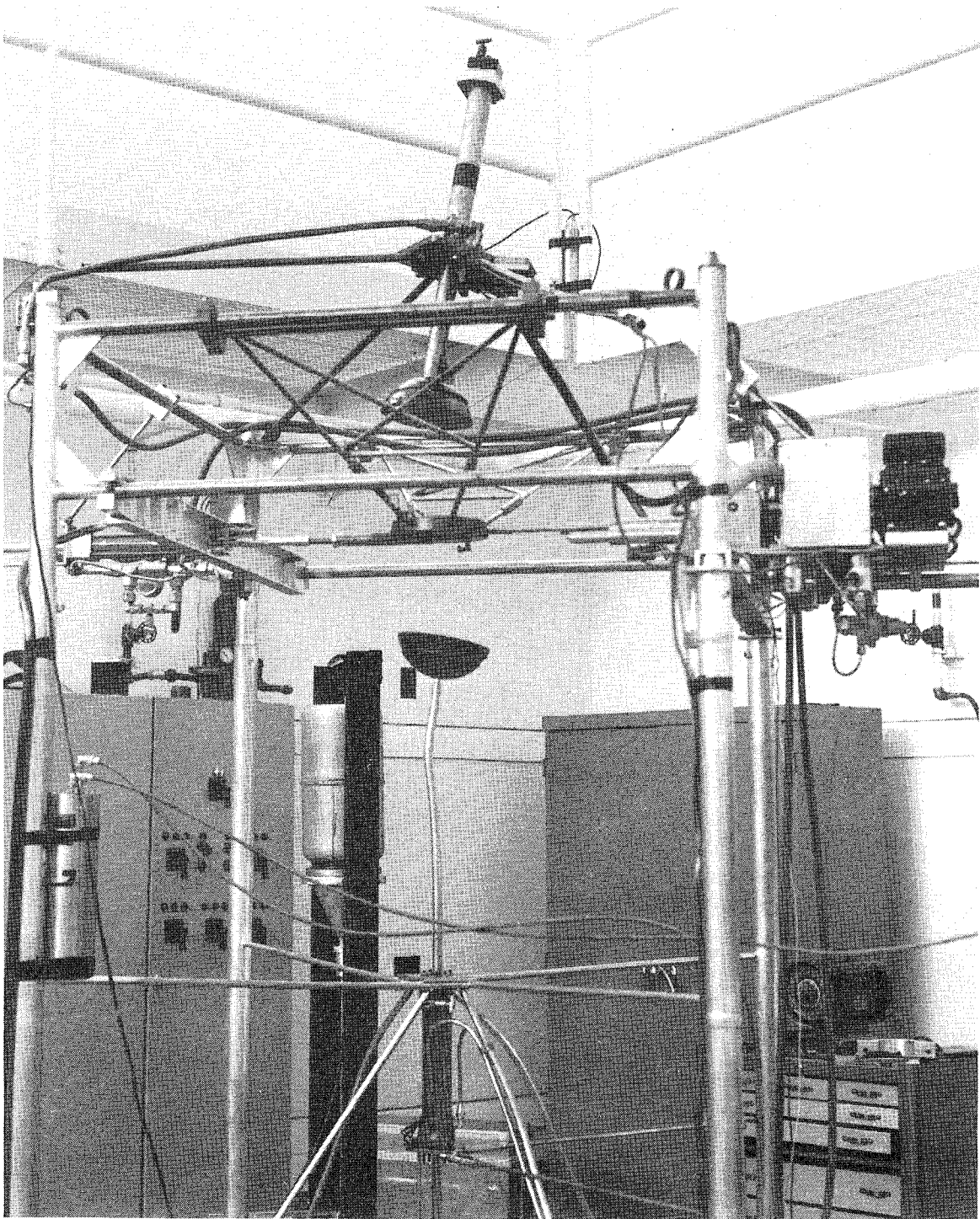

Fig. 15. Lady Godiva after the excursion of February 3, 1954 .



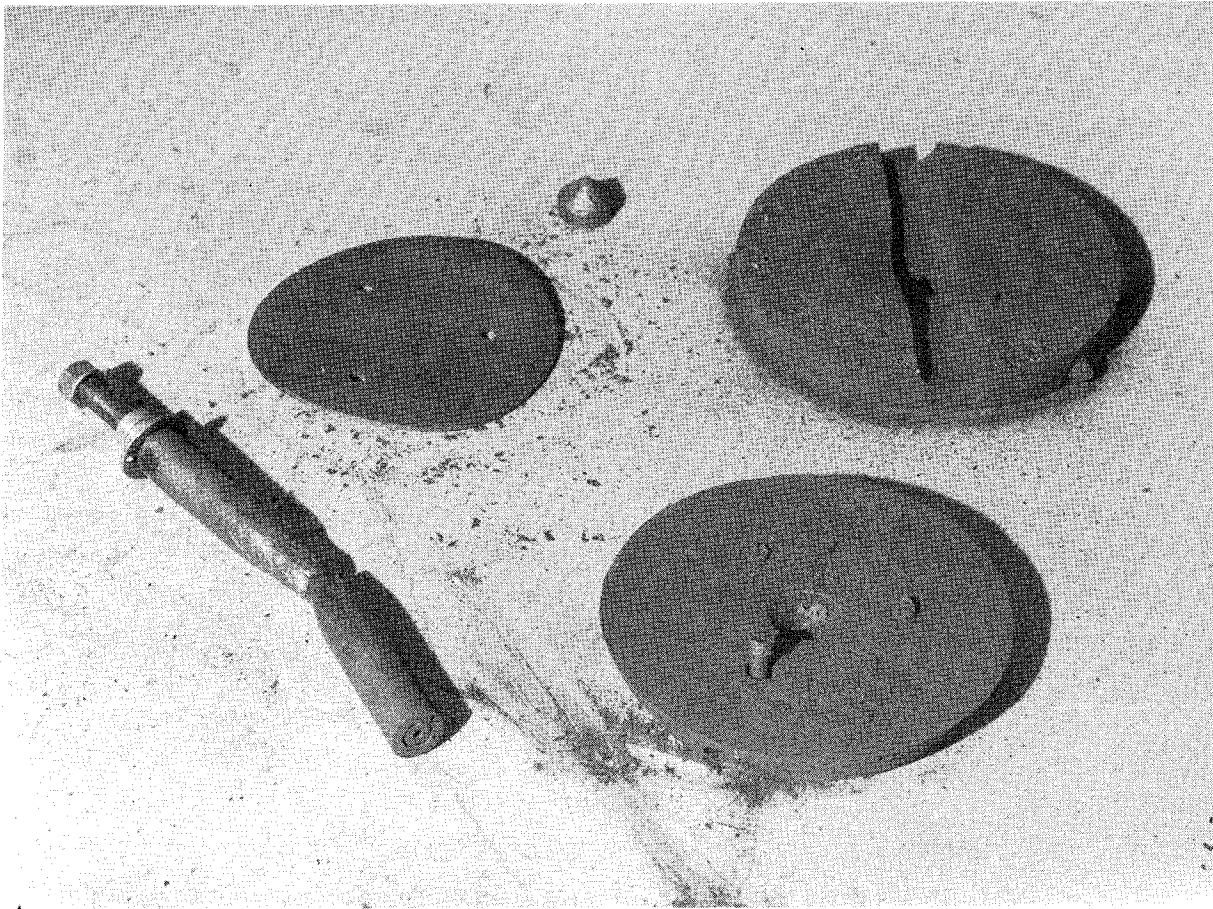

Fig. 16. Burst rod and several sections of Lady Godiva showing oxidation and warpage that accompanied the second accident.

#### II-B.7 Los Alamos Scientific Laboratory, June 17, 1960

##### *Graphite-reflected, cylindrical $^{235}\text{U}$ metal system.*

The critical parameters of highly enriched (93%  $^{235}\text{U}$ ) uranium metal cylinders in thick graphite (about 9 in.) and near-infinite water reflectors were being investigated. In the experiment of interest, an approximate 48-kg uranium annulus was built up on a cylinder of graphite that, in turn, rested on a hydraulic lift device. This annulus was raised by remote control into a reflector of graphite resting on a stationary steel platform. The system became critical before complete assembly and was scrammed both manually and automatically at about 1 in. from closure. Following the scram signal, the lift dropped rapidly and the system became subcritical, but about 1/3 of the metal mass stuck in the graphite reflector for a few seconds before falling to the floor. The yield was  $6 \times 10^{16}$  fissions; there was no contamination or damage to the fissile metal. Personnel radiation doses were immeasurably small.

This incident was, in many respects, similar to that of Jemima. The reactivity sensitivity of this particular experiment was not measured after the power transient

but, from examination of similar systems, the reactivity insertion rate probably did not exceed a few dollars per second and the initial spike could have included  $10^{15}$  fissions.

The fission yield was very close to that of the first Godiva accident (Feb. 3, 1954,  $5.6 \times 10^{16}$  fissions), and the two masses are quite comparable. In the earlier case, all of the energy release took place during the power spike and some warping of pieces and damage to supports was seen. In this transient, the metal was undamaged, thus supporting the assertion that the initial power spike was small compared to the total yield.

#### **II-B.8 Oak Ridge National Laboratory, Nov. 10, 1961<sup>31</sup>**

*<sup>235</sup>U metal, paraffin-reflected.*

This power transient in about 75 kg of highly enriched (about 93% <sup>235</sup>U) uranium metal reflected with paraffin took place while one portion on a vertical lift machine was approaching the other, stationary, portion. The experiment was the last of a series during which uranium or paraffin had been added by increments to change the reactivity of the complete system; all previous experiments had been subcritical when fully assembled. In this case the system became supercritical while the lift was in motion, leading to a yield of between  $10^{15}$  and  $10^{16}$  fissions.

The closure speed of the lifting device was 16 in./min; delayed criticality was later determined to be at a separation distance of 2.7 in. The sensitivity of the system at this point was 8.6  $\$/in.$  Thus, the reactivity insertion rate was 2.3  $\$/s$  and a lift slowdown, which became effective at 1.94 in., did not affect the course of the transient.

The reactivity and power histories must have been similar to those of the Jemima accident, except that the pertinent scram delay time was only 50 ms in this case. The initial spike could not have exceeded  $10^{15}$  fissions, and the remaining energy must have been created during the subsequent plateau. The appearance of the metal (smooth, no oxide) and the fact that the paraffin did not melt qualitatively confirmed the yield estimate of  $10^{15}$  to  $10^{16}$  fissions. Personnel radiation doses were trivial, and the laboratory was ready for normal use within 1-1/2 h.

#### **II-B.9 Lawrence Livermore Laboratory, March 26, 1963<sup>32</sup>**

*Beryllium-reflected, cylindrical metal system.*

The critical assembly consisted of concentric cylinders of highly enriched uranium metal surrounded by a beryllium reflector. The total enriched uranium mass of 47 kg was divided into two parts with the central core on a lift device and the larger diameter rings with the reflector on a fixed platform. The approach to criticality was to be achieved by lifting the core in a series of steps into the reflected annulus. The experiments were performed in a heavily shielded vault, adjacent to the area in which the Kukla reactor produced prompt bursts of neutrons.

This stepwise assembly procedure was successfully followed for seven multiplication measurements. After the eighth apparently normal assembly, the system suddenly became highly supercritical. An explosive sound was heard, scrams and alarms were actuated, and, after a few seconds, the uranium could be

seen melting and burning. The yield was later measured at  $3.76 \times 10^{17}$  fissions, but little or no explosive energy was generated. About 15 kg of uranium burned, and about 10 kg melted and spread over the floor. Exposure to personnel in or near the building was low and in no case exceeded 0.12 rem. The reactor room was highly contaminated.

The incident is believed to have been caused by the central cylinder of metal on the lift being very slightly off center. When it was lifted into the fixed half, one or more of the metal rings was carried upward. Following the eighth assembly, the system adjusted itself and the rings settled properly around the central core, abruptly increasing the reactivity. The rate is not known, nor is the maximum reactivity. The initial spike probably did not exceed  $10^{16}$  fissions with most of the energy being generated during a high plateau. Quenching came through thermal expansion and melting.

## II-B.10 White Sands Missile Range, May 28, 1965<sup>33</sup>

### *Unreflected uranium-molybdenum metal fast-burst reactor.*

The success of the Godiva reactor in creating very sharp, intense bursts of near-fission-spectrum neutrons has stimulated the development of several similar reactors for production of pulsed irradiations. One of these is the White Sands Missile Range Fast Burst reactor, which is composed of 96 kg of an alloy of highly enriched uranium and 10 wt% molybdenum. This reactor design is somewhat similar to the Godiva II reactor<sup>24</sup>—seven rings and a top plate all of which partially enclose a large central volume that, at criticality, is filled with a safety block. Two control rods and a burst rod penetrate the rings. The assembly is held together by three metal bolts. Initially, the bolts were stainless steel, but just prior to the incident they were replaced by bolts composed of the uranium-molybdenum alloy, and recalibration of the reactivity worth of various components was underway. The new worth of the control rods, burst rod, minor components, and the first 1/2-in. withdrawal of the safety block had been measured.

Further calibration of the safety block seemed to require higher neutron flux than that given by a polonium-beryllium neutron source. To obtain a power of about 1 W, an interlock was bypassed and the safety block was set into motion inward, approaching a state thought to be known. The excursion took place as the safety block neared the 1/2-in. position.

All scrams functioned as designed, but the short period allowed a very high power to be attained, and the excursion was actually terminated by thermal expansion of the metal. The new uranium-molybdenum assembly bolts failed (the heads snapped); the two top rings and minor parts were tossed distances of 5 to 15 ft.

This incident was well instrumented. The minimum period was 9.2  $\mu$ s, the maximum reactivity 0.15  $\beta$  above prompt criticality, the reactivity insertion rate 2.2  $\beta$ /s, and the burst width 28  $\mu$ s. The internal temperature rise of 290°C suggested a fission yield of  $1.5 \times 10^{17}$ , which is only 1.4 times the maximum expected from normal operations.

During this unexpected burst, damage was limited to the failure of the assembly bolts and very slight chipping of the nickel coating of the rings. Personnel

radiation doses were immeasurably small. One hour after the excursion the cell was entered and radiation levels were determined to be higher than normal background, but not appreciably higher than those measured after a routine burst.

#### **II-B.11 Aberdeen Proving Ground, Md., Sept. 6, 1968<sup>34</sup>**

*Unreflected uranium-molybdenum metal fast-burst reactor.*

The Army Pulse Radiation Facility Reactor (APRFR) is another of the series of Godiva-like reactors. The APRFR design evolved from the Health Physics Research Reactor of the Oak Ridge National Laboratory and was intended to provide large values of neutron flux and fluence.

During preoperational testing, several minor variations in the reactor configuration were studied in a program to optimize performance. During this testing, an unexpectedly large burst ( $6.09 \times 10^{17}$  fissions) occurred. It exceeded, by about a factor of three, the maximum burst size the reactor was expected to withstand without damage; internally the core reached the melting point of the fuel, 1150°C. The initial period was measured as 9.1  $\mu$ s, and the reactivity was estimated to have been about 0.18  $\beta$  above prompt criticality. The planned excess reactivity for this burst was 0.0805  $\beta$ , which was expected to result in a burst of  $1.68 \times 10^{17}$  fissions.

Post-accident analysis indicated that the extra reactivity resulted from a reactor configuration such that the burst rod passed through a reactivity maximum before seating. This condition had not been recognized; apparently on previous operations the burst rod had reached its seated position before the arrival of an initiating neutron. In the absence of a strong neutron source, wait times before an excursion occurs can be long. (See Fig. 21.)

Damage was limited to the fuel components of the reactor and included some warping and spalling as well as elongation of bolts. The four central rings fused together at the inner surface and experienced some cracking.

There were no detectable external or airborne radiation hazards, and no personnel overexposures.

## C. MODERATED METAL OR OXIDE SYSTEMS

### II-C.1 Los Alamos, New Mexico, June 6, 1945<sup>16</sup>

*Pseudosphere of uranium cubes, water-reflected, local control.*

The experiment, designed before the days of remote control, was intended to establish the critical mass of enriched uranium metal when it was surrounded by hydrogenous material. The uranium mass of 35.4 kg (average enrichment 79.2%) was stacked in the form of a pseudosphere constructed of 1/2-in. cubes and 1/2-in. × 1/2-in. × 1-in blocks. The core was in a 6-in. cubical polyethylene box with the void space filled with polyethylene blocks. The whole assembly was placed in a large tank that was then partially filled with water.

The assembly became critical (unexpectedly) before water had completely covered the polyethylene box. The situation was aggravated because no scram device was built into the system and the inlet and drain valves were 15 ft apart. Before the system was reduced to a safe subcritical state 5 or 10 s later, a total of 3 to  $4 \times 10^{16}$  fissions occurred, representing an energy release sufficient to raise the average temperature of the metal more than 200°C. Subsequent examination of the polyethylene box showed that it was not watertight. It is probable that water seeped slowly into the uranium assembly as the water level was being raised above the bottom of the box. The additional moderation then caused the super-critical situation that was terminated by boiling of the water within the box and next to the metal cubes.

Recent calculations by O. D. Thompson have provided some insight into this event. Nesting spherical shells of U(79.2) (thickness of 8 mm and total mass of 35.4 kg) were evaluated with gaps between shells of 0.5 and 1 mm. Adding water to the gaps increased the multiplication factor by 0.04 for the 1-mm gap, while for the 0.5-mm case,  $\Delta k$  was found to be about 0.02. These results apply to the assembly fully reflected by water, where the calculated  $k_{eff}$  was 1.024 and 1.018, respectively. The full water reflector was found to be worth about 0.21 in  $k$ . While the geometry of the calculations represents only a rough approximation of the actual assembly, refinements are probably not justified. Indications are that the uranium cubes were "as cast," so the actual volume available to the water cannot be known.

The characteristics of excursions of large masses of fissile metal in water are, at best, poorly known. A calculation by Hansen has shown that for a 6.85-cm radius <sup>235</sup>U sphere in water, 15% of the fissions occur in the outer 0.05 cm and the fission density in this region is six times that at the center. A spike of  $3 \times 10^{15}$  fissions would then raise the surface temperature 130°C, while the central regions would remain relatively cool with a temperature rise of only 19°C. The initial spike must have been of this order of magnitude, with the majority of the fissions following at a much lower average power.

In this excursion three people received radiation exposures in the amounts of 66, 66, and 7.4 rep. There was no contamination, and the active material was used again in 3 days.

## II-C.2 Chalk River Laboratory, late 1940s or early 1950s

### *ZEEP Critical Facility.*

The ZEEP facility consisted of aluminum-clad uranium metal rods in a heavy-water moderator. The cylindrical aluminum reactor tank was reflected by graphite on the sides and bottom, shielded on the sides by 3-ft-thick water tanks, and unshielded on the top. Reactivity was controlled by the level of the heavy water, which was supplied from a storage tank by an electrically driven pump. As a safety feature, the pump was controlled by a timer that required the pump to be restarted by a pushbutton switch every 10 s or so.

Cadmium-coated plates suspended on cables between the reactor tank and the graphite reflector served as safety rods. The scram circuit was set to trip at a power of about 3 W.

At the time of the accident two physicists were working on the top of the reactor, inserting foils into reentrant tubes. A technician raising the water level in the reactor with the pump control had instructions to stop at a water level predetermined to be many minutes of pumping below predicted criticality.

One of the physicists asked the technician to bring a tool to the top of the reactor. So as not to lose time and in direct contravention of instructions, the technician inserted a chip of wood into the pump control button so the timer would reset each time it ran out. He then went to the reactor top and became involved in the work being done there, while the heavy-water level continued to rise.

The reactor became critical and scrammed as designed. The pump was stopped automatically by an interlock in the scram circuit. The NRX reactor in the adjacent building was scrammed by sky-shine radiation. Subsequent evaluations indicated that the ZEEP power level had coasted above the preset scram power level, perhaps by several factors of two.

The three people on the reactor top each received radiation exposure in excess of the quarterly permissible dose and, perhaps, above the annual dose.

## II-C.3 Argonne National Laboratory, June 2, 1952<sup>35</sup>

### *Reactor mockup, UO<sub>2</sub> particles in plastic, water-moderated.*

This accident occurred in a light-water-moderated core in which 6.8 kg of <sup>235</sup>U oxide were embedded in strips of polystyrene plastic. All but 0.5% of the oxide particles were 10 μm in diameter or less, the remainder, up to 40 μm in diameter. Seven strips of the plastic fastened to six zirconium strips (0.91 in. × 0.110 in. × 43 in.) formed one standard fuel element. The core was roughly cylindrical and contained 324 fuel elements. The zirconium, fuel strips, and water occupied 60%, 7.71%, and 32.2%, respectively, of the core volume.

The experiment in progress at the time of the accident consisted of making comparisons of the worth of central control rods of different design. The system became super-prompt critical following an attempt (contrary to operating procedures) to replace the central control rod when the normal amount of water was in the core. Peripheral poison rods were in position but were inadequate to prevent criticality.

The quenching mechanism for the excursion of  $1.22 \times 10^{17}$  fissions was the near-uniform expansion of the plastic as the 10  $\mu\text{m}$  particles became hot and the bubble formation in the neighborhood of the 40  $\mu\text{m}$  particles. This forced most of the water out of the core, and the entire excursion was over about 0.6 s after the operator started raising the control rod. The maximum reciprocal period was nearly 100/s, the maximum power was  $1.7 \times 10^8$  W, and the half-width of the power spike was 18.5 ms.

In this excursion the core fuel elements were ruined, but no significant amount of fissile material was lost. The activity in the reactor room was above tolerance for about a day. The core elements were removed after 5 days, and decontamination was completed by a single application of detergent and warm water. Four persons received radiation doses in the amounts 136, 127, 60, and 9 rep.

#### **II-C.4 Atomic Energy of Canada, Ltd., Chalk River, Ontario, Dec. 12, 1952<sup>36,37</sup>**

*NRX reactor, natural uranium rods, heavy-water moderated, graphite reflected.*

The NRX reactor is a natural uranium, heavy-water-moderated system with the uranium rods cooled by a thin sheath of light water flowing between the aluminum-clad fuel rod and a slightly larger concentric aluminum cylinder. The heavy-water moderator reduced the neutron energy enough that the light-water coolant served as a poison.

Through a very complicated series of operator errors and electrical and mechanical safety circuit failures, the reactor was forced to be supercritical by about 60  $\epsilon$ . Initially the power increased rapidly but, because of a slowly moving control rod, the reactor gave every indication of leveling off at a power of about 20 MW. Normally this would have been a high but tolerable power and, very likely, the situation would have been controllable if the experiments underway had not required reduced light-water cooling flow for several of the fuel rods. At a power of about 17 MW, the cooling water commenced to boil in those channels with reduced flow. This autocatalytic action (the light water was effectively a poison) increased the reactivity by about 20  $\epsilon$  and the power rose again, with a period estimated to be between 10 and 15 s. When the power reached 60 to 90 MW, the heavy-water moderator was dumped and the reaction stopped.

The reactor power was greater than 1 MW for no more than 70 s, and the total energy release has been estimated at 4000 MJ, or about  $1.2 \times 10^{20}$  fissions. The core and calandria (fuel element support structure) were damaged beyond repair. Some 104 Ci of long-lived fission products were carried to the basement by a flood of 106 gal of cooling water. Personnel irradiations were apparently low; the reactor was restored to operation in slightly more than a year.

#### **II-C.5 Argonne National Laboratory, Idaho Reactor Testing Area, July 22, 1954<sup>38,39,40</sup>**

*BORAX reactor, aluminum-uranium alloy, water-moderated, remote control.*

This excursion was an accident only in the sense that it was larger than expected. The BORAX-I reactor<sup>41</sup> had been built as a temporary affair; steady-state and transient studies were regarded as complete; and it was decided that the reactor

should be forced onto a short-period transient to obtain the maximum amount of experimental information before it was dismantled. The excess reactivity was chosen to produce a fission yield such that about 4% of the fuel plates would melt.

The BORAX-I reactor consisted of 28 MTR-type fuel elements moderated by light water. Each element contained 18 fuel plates 2.845 in.  $\times$  0.060 in.  $\times$  24.6 in. consisting of aluminum-uranium alloy clad with about 0.020 in. of aluminum. The total uranium inventory was 4.16 kg, and the whole core was in a semiburied tank 4 ft in diameter and 13 ft high.

It had been estimated from earlier controlled prompt excursions that about 4% excess  $k$  would put the reactor on a period between 2.0 and 2.5 ms and that the resulting excursion would release about 80 MJ of fission energy. To perform this experiment a larger than usual fuel loading and a more effective central control rod were required.

The excursion and associated steam explosion, following rapid ejection of the control rod, completely disassembled the reactor core and ruptured the reactor tank (Fig. 17). Very extensive melting of the fuel plates occurred; some elements remained in the tank while small pieces were found up to 200 ft away.

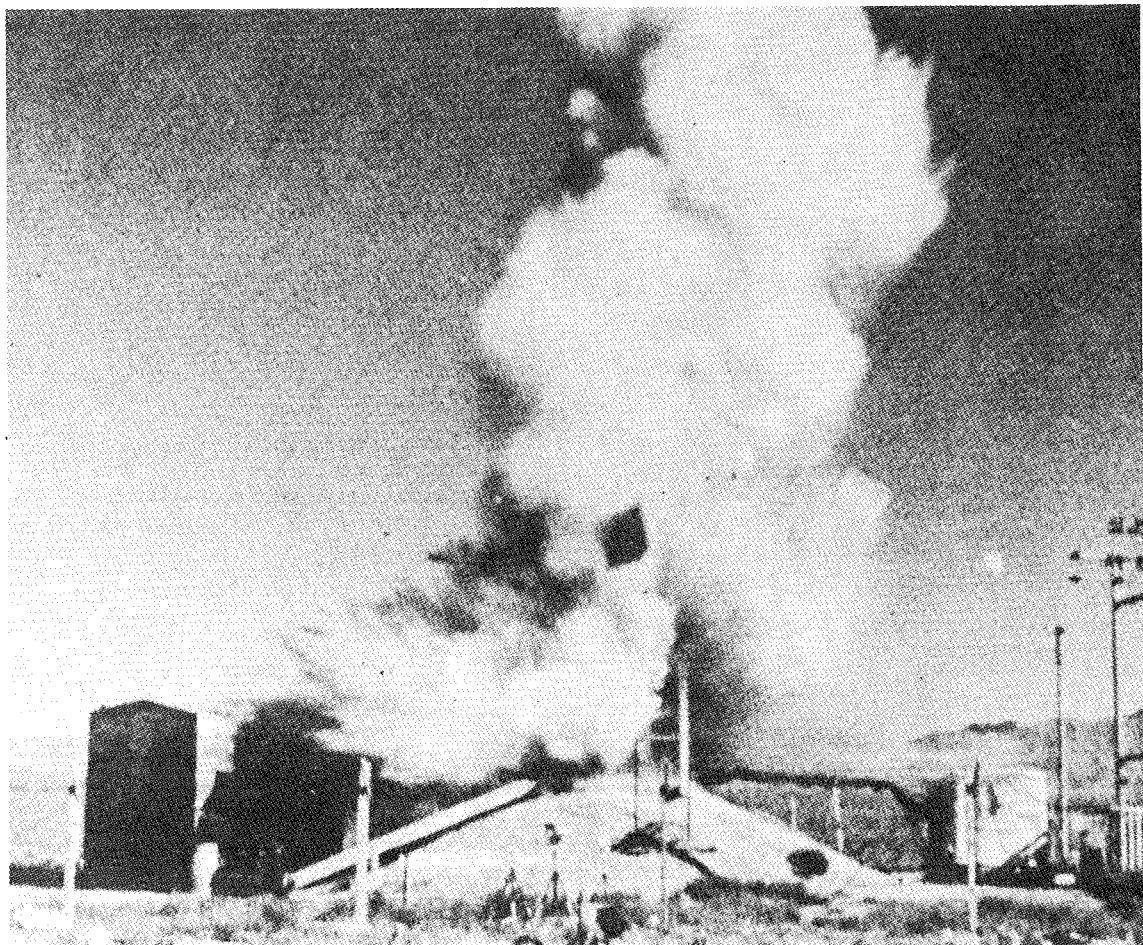

Fig. 17. The destructive excursion in BORAX, July 22, 1954.



"An example of the force of the explosion was the carrying away of the control rod mechanism. This mechanism, which weighed 2,200 lb, sat on a base plate, about 8 ft above the top of the reactor tank. Except for the base plate, about 4 ft square, the top of the 10-ft shield tank was essentially unobstructed. The force of the explosion, plus the impingement of water and debris on the base plate, tore the plate loose from its coverage and, as revealed by high-speed movies, tossed the mechanism about 30 feet into the air."<sup>41</sup>

The total energy release was 135 MJ instead of the predicted 80 MJ or, assuming 180 MeV deposited per fission,  $4.68 \times 10^{18}$  fissions. This energy is equivalent to that contained in about 70 lbs of high explosive, but it has been estimated that between 6 and 17 lb of HE would produce comparable damage. The minimum period was 2.6 ms, and the maximum power was about  $1.9 \times 10^{10}$  W. It is apparent that the nuclear excursion was completed before the steam explosion destroyed the system.

In this excursion the reactor was destroyed but, because of the remote site, physical damage was limited to the reactor. None of the personnel received any radiation dose.

#### II-C.6 Vinca, Yugoslavia, Oct. 15, 1958<sup>\*42</sup>

*Unreflected, D<sub>2</sub>O-moderated, natural uranium assembly, unshielded.*

The critical facility at the Boris Kidrich Institute in Vinca, Yugoslavia, was composed of an unreflected matrix of natural uranium rods moderated by heavy water. The aluminum-clad rods were 2.5 cm in diameter and 210 cm long; the total core uranium mass was 3,995 kg in a volume of  $6.36 \times 10^6$  cm<sup>3</sup>. Two cadmium safety rods were installed but not interlocked with the flux recorder. The liquid level was normally used to control the system reactivity (critical level, 178 cm).

At the time of the accident a subcritical foil-counting experiment was in progress. To obtain as much activation of the foils as possible it was desired to raise the multiplication to some high, but still subcritical, level. This was done by raising the heavy water in the tank in a series of steps. On the last step, two of the BF3 chambers performed as before—leveling off at a higher signal level, but the third behaved erratically and was disconnected.

After the assembly had been at this D<sub>2</sub>O level about 5 to 8 min, one of the experimenters smelled ozone and realized that the system was supercritical at some unknown power level. The cadmium safety rods were used to stop the reaction.

Later investigation showed that both of the detecting chambers that were believed to be working properly had reached saturation and were reading a constant maximum value even though the power level was rising steadily.

Irradiations were intense, being estimated at 205, 320, 410, 415, 422, and 433 rem.<sup>43</sup> Of the six persons present, one died and the other five recovered after severe cases of radiation sickness. The critical assembly withstood the energy release of 80 MJ (about  $2.6 \times 10^{18}$  fissions) with no reported damage.

---

<sup>\*</sup>We are indebted to Dr. T. J. Thompson for first reporting the correct sequence of events. Some of the details of this incident are taken verbatim from his discussion.

### II-C.7 Centre d'Etudes Nucleaires de Saclay, France, March 15, 1960<sup>15</sup>

*UO<sub>2</sub> rods, uranium enriched to 1.5%.*

The Alize critical assembly was a water-reflected and water-moderated system utilizing, in this case, UO<sub>2</sub> rods as fuel in which the uranium was enriched to 1.5%. The rods were 1 m long and 1 cm in diameter with the total UO<sub>2</sub> mass equal to 2.2 tons.

The experiment in progress at the time of the incident required a stable positive period at a very low power. To accomplish this, the critical rod configuration was found experimentally and the rod position required for the necessary period was calculated. After allowing for the decay of delayed neutron precursors, the rods were withdrawn to the predetermined position. However, for reasons unknown, the operator then completely withdrew a rod that previously was not fully out. This placed the system on a period of about 1/4 s.

The subsequent power excursion created  $3 \times 10^{18}$  fissions, but the peak temperatures in the UO<sub>2</sub> were less than 550°. The core was undamaged, and personnel radiation doses were trivial.

It was deduced that the quenching action must have been a result of the <sup>238</sup>U Doppler effect. This judgment was substantiated by the Spert experiments with a similar core in which the uranium was enriched to 4% (II-C.9).

### II-C.8 Stationary Low-Power Reactor No. 1, Idaho Reactor Testing Area,

Jan. 3, 1961<sup>42,44,45</sup>

*SL-1 reactor, aluminum-uranium alloy, water-moderated*

The SL-1 reactor (originally known as the Argonne Low Power reactor) was a direct-cycle, boiling-water reactor of 3 MW gross thermal power using enriched uranium fuel plates clad in aluminum, moderated, and cooled by water. Because the reactor was designed to operate for 3 years with little attention, the core was loaded with excess <sup>235</sup>U. To counterbalance the excess of <sup>235</sup>U, a burnable poison (<sup>10</sup>B) was added to some core elements as aluminum-boron 10-nickel alloy. Because the boron plates had a tendency to bow (and, apparently, to corrode, increasing reactivity), some of them were replaced in November 1960 with cadmium strips welded between thin aluminum plates. At that time the shutdown margin was estimated to be 3% (about 4 \$) compared to the initial value of 3-1/2 to 4%. The cruciform control rods, which tended to stick, were large cadmium sheets sandwiched between aluminum plates. The nuclear accident was probably independent of the poor condition of the core.

After having been in operation for about 2 years, the SL-1 was shutdown December 23, 1960, for routine maintenance; on January 4, 1961, it was again to be brought to power. The three-man crew on duty the night of January 3 was assigned the task of reassembling the control rod drives and preparing the reactor for startup. Apparently they were engaged in this task when the excursion occurred.

The best available evidence (circumstantial, but convincing) suggests that the central rod was manually pulled out as rapidly as the operator was able to do so. This rapid increase of reactivity placed the reactor on about a 4-ms period; the power continued to rise until thermal expansion and steam void formation quenched the

excursion. The peak power was about  $2 \times 10^4$  MW, and the total energy release was  $133 \pm 10$  MJ.

The subsequent steam explosion destroyed the reactor and killed two men instantly; the third died 2 h later as a result of a head injury. The reactor building, and, especially, the reactor room were very seriously contaminated by the reactor water, which carried fission products with it. Initial investigations were hindered by the high radiation field (500 to 1000 R/h) in the reactor room. In spite of the large radioactivity release from the core, very little escaped from the building, which was not designed to be airtight.

In many respects this reactor excursion resembled that of the BORAX and Spert destructive experiments. Each of these, and especially Spert (II-C.9), was instrumented to follow just such an excursion. W. Nyer<sup>45</sup> notes that the crucial parameter is the energy density in the core. This is larger for the SL-1, but not grossly so, being 12% more than BORAX and 60% more than Spert. The prompt alpha for SL-1 seems to have been slightly lower. The steam explosion caused considerable damage in all three power transients, especially in BORAX and SL-1. In SL-1 the core was enclosed and the water apparently was accelerated upward more or less as a single slug. The energy acquired by the water was sufficient to lift the entire reactor vessel some 9 ft before it fell back to its normal position.

In the Spert experiments, the steam explosion followed the nuclear power spike by 15 ms. It is not known if such a delay occurred following the SL-1 power transient.

## II-C.9 Spert Reactor Test, Idaho Reactor Testing Area, Nov 5, 1962

### *Spert.*

The Spert reactor was a small test facility designed to investigate the transient behavior of water-moderated and cooled plate type reactors. The fuel consisted of plates of highly enriched uranium alloyed with aluminum and clad with the same material. Previous test programs had produced data for transients whose initial period exceeded 8 ms. These experiments were nondestructive, having resulted in only minor fuel-plate distortion. However, some data of a destructive nature was obtained for a 2.6-ms period in the 1954 BORAX-1 test that resulted in an explosion that destroyed the reactor. The Spert experiments were therefore designed to investigate the transition from essentially nondamaging to destructive excursions.

After completion of a long experimental program, two tests were conducted resulting in periods of 5.0 and 4.6 ms. These resulted in some plate distortion and some limited fuel melting. The transient behavior was regarded as a reasonable extrapolation of data from earlier experiments having longer periods. There was no indication that further extrapolation was not valid.

In the final test with a 3.2-ms period (energy release 30.7 MJ) all 270 plates showed melting to some degree, with the average molten fraction about 35%. The performance of this test, from the nuclear point of view, was very close to predicted. Evidently the nuclear characteristics of the shutdown were essentially identical to the earlier transients and involved fuel and moderator thermal expansion and boiling of water. However, about 15 ms after the nuclear transient was terminated, a

violent pressure surge resulted in total destruction of the core. This is attributed to a steam explosion caused by rapid energy transfer from the molten fuel to the water moderator.

Fuel, water, and core structure were violently ejected from the vessel in which the experiment took place.

This experiment was instrumented to measure the activity of any fission products that might be released, even though no violent excursion was expected. The measurements showed that about 7% of the noble gases produced during the transient escaped to the atmosphere. (The roof and some of the siding of the reactor building had been removed prior to the test, so the building provided only limited confinement.) Neither solid fission products nor any radioiodines were found in the atmosphere.

Based on the detection sensitivity of the instrumentation and the lack of any indicated presence of iodine, it was established that less than 0.01% of the radioiodines produced had escaped to the atmosphere.

#### II-C.10 Mol, Belgium, Dec. 30, 1965<sup>15</sup>

*VENUS critical facility, 7% enriched UO<sub>2</sub> rods in H<sub>2</sub>O-D<sub>2</sub>O.*

VENUS was a tank-type, water-moderated, critical assembly machine used for experiments apropos of the Vulcan reactor. This was a "spectral shift" reactor, so-called because the initial moderator of D<sub>2</sub>O could be diluted with H<sub>2</sub>O to soften the spectrum and maintain reactivity as the fissile material was consumed. For the experiments in progress, the composition of the moderator and reflector was 70% H<sub>2</sub>O and 30% D<sub>2</sub>O; the reflector extended 30 cm above the top of the core. The height and diameter of the core were about 1.6 meters. The fuel was UO<sub>2</sub> in the form of pelleted rods, the total mass of UO<sub>2</sub> was  $1.2 \times 10^6$  g, and the <sup>235</sup>U enrichment was 7%.

The primary reactivity control was by motion of poison rods (eight safety rods and two control rods); eight additional absorbing rods were available for manual positioning in the core.

Just before the accident, all safety rods were in, a control rod was in, seven manual rods were in, and a control rod was being inserted; the reactor was subcritical by one safety rod and one control rod.

To perform an experiment with a new rod pattern, the operator of the reactor decided to decrease reactivity by inserting the last manual rod, waiting until the second control rod was fully inserted. Then, as the reactor should have been subcritical by one safety rod, two control rods, and one manual rod, a different manual rod located near the last one inserted could be pulled out of the core and the reactor made critical again by lifting two safety rods.

Such a program required a man to insert one manual rod and extract another. The operator did not take into account a rule written into the Safety Report of the reactor, i.e., that no manipulation of a manual rod in the core should be performed without first emptying the vessel. He gave a written order to a technician prescribing the loading of a manual rod followed by the unloading of another one. The technician did not wait until the moving control rod reached its bottom

position and started the manipulation in the wrong order. He first extracted a manual rod instead of first inserting the other.

During the extraction of the manual rod the reactor became critical. The technician had his left foot projecting over the edge of the tank and resting on a grating that was about 5 cm above the reflector; his right foot and leg were somewhat behind him and partly shielded. He noticed a glow in the bottom of the reactor, immediately dropped the control rod, and left the room.

The energy release was about 13 MJ ( $4.3 \times 10^{17}$  fissions) and, apparently, the excursion was stopped by the falling manual rod, although the scram may have been speeded up by a combination of the Doppler effect and emptying of the vessel, which was automatically "provoked." This is uncertain.

No steam was created, no damage was done to the fuel, and there was no contamination. The technician received a severe radiation dose, primarily gamma rays. Eight days later and after 300 measurements in a phantom, rough estimates were that the dose to his head was 300 to 400 rem, to his chest 500 rem, and to his left ankle 1750 rem. At the end of his foot the dose approached 4000 rem. Medical treatment of the patient was successful, except that the left foot had to be amputated.

#### **II-C.11 The RA-2 Facility, Buenos Aires, Argentina, Sept. 23, 1983<sup>46</sup>**

##### *MTR-type fuel elements in a pool-type reactor.*

Control rods for this essentially zero-power experimental reactor facility were MTR elements in which 4 of the 19 fuel plates were removed and replaced by 2 cadmium plates. Just outside the fueled region (approximately 30.5 cm  $\times$  38 cm) was a graphite reflector approximately 7.5 cm thick. The large reactor vessel was filled with demineralized water during operations and was supposed to be drained during changes in fuel configurations when people were required to be present.

The technician, a qualified operator with 14 year's experience, was alone in the reactor room making a change in the fuel configuration. The moderator had not been drained from the tank, though required by procedures. Two fuel elements had been placed just outside the graphite, instead of being removed completely from the tank. Two of the control elements, without the cadmium plates installed, were being placed in the fuel configuration. Apparently criticality occurred as the second of these was being installed, since it was found only partially inserted.

The excursion consisted of 3 to  $4.5 \times 10^{17}$  fissions; the operator received an absorbed dose of about 2000 rad gamma and 1700 rad neutron. This exposure was highly nonuniform, with the upper right side of the body receiving the larger exposure. The operator survived for 2 days. Two people in the control room received exposures of about 15 rad neutron and 20 rad gamma. Six others received lesser exposures, down to 1 rad, and nine received less than 1 rad.

## D. MISCELLANEOUS SYSTEMS

### II-D.1 Los Alamos, New Mexico, Feb. 11, 1945<sup>47,48</sup>

*The Dragon reactor, UH<sub>3</sub> pressed in styrex, shielded operation.*

The Dragon reactor was the first fissile system designed to generate prompt power excursions and, probably, it was the first reactor of any kind whose reactivity exceeded prompt criticality.\* This was accomplished by intent January 18, 1945; the temperature rise is quoted as 0.001°C,<sup>47</sup> and the yield (not quoted) can be estimated to have been about  $2 \times 10^{11}$  fissions.

The Dragon was made of enriched UH<sub>3</sub> pressed with a special plastic, styrex, into small cubes of average chemical composition UC<sub>4</sub>H<sub>10</sub>. The configuration for the final experiments, containing only 5.4 kg of this material, was diluted with polyethylene and reflected by graphite and polyethylene.

The reactor was made prompt critical for about 1/100 s by dropping a slug of the active material through a vertical hole in the remaining portion, which was stacked on a 3/8-in. steel table. The falling slug of active material was contained in a steel box, its path closely defined by four guides.

Generally, the fission energy did not contribute to the quench of the excursion; the burst size was determined by the background fission rate and the stacking configuration on the table. Thus, the burst size could be varied by moving a reflector nearer the assembly or by increasing the background fission rate. Both techniques were often employed, and this may have been the case in the final experiment because the bursts were being made steadily larger. During the final excursion of about  $6 \times 10^{15}$  fissions, the UH<sub>3</sub> cubes became so hot that blistering and swelling occurred. The whole system had expanded about 1/8 in.

In the final excursion, the core material was damaged but no active material was lost, there was no contamination, and no one received any radiation.

### II-D.2 The U.S.S.R, 1953 or 1954<sup>49</sup>

This incident apparently took place in 1953 or early 1954. The location, date, facility, burst yield, and causes are not mentioned. Two persons described as being "close to the reactor" and "in close proximity to the reactor" were subjected to "a short, general external gamma and neutron irradiation" equivalent to 300 and 450 R, respectively. Their exposures could have been caused by a power excursion of any one of a large number of possible systems, but one suspects a small critical assembly, possibly metallic, whose stacking was unintentionally increased to a reactivity well above delayed criticality and possibly above prompt criticality. It is likely that the burst yield was in the range of  $10^{16}$  to  $10^{17}$  fissions. It may be noted that the radiation dose at 1 m from a Godiva burst of  $10^{16}$  fissions is 400 R (30 R gamma and 370 R neutron).

---

\*R. Feynman pointed out the similarity of the procedures used in these experiments to tickling the tail of a dragon, thus it has been called the "Dragon Experiment." The name is often applied to the class of prompt-burst experiments where reactivity is added and subtracted mechanically and where quenching mechanisms dependent upon the fission energy released do not contribute significantly to the shutdown process.

**II-D.3 Argonne National Laboratory, Idaho Reactor Testing Area, Nov. 29, 1955<sup>50,51</sup>**  
*EBR-1, enriched uranium fast-breeder reactor, shielded operation.*

Design of the EBR-1 fast neutron reactor was started in 1948 with the objectives of establishing possible breeding values and demonstrating the feasibility of cooling a metal-fueled reactor with liquid metals. These objectives were met, and, indeed, in early 1952 the plant furnished more than enough electrical power for the reactor and the reactor building; excess steam was blown to the condenser.

The reactor core consisted of cylindrical, highly enriched uranium rods slightly less than 1/2 in. in diameter canned in stainless steel with a bonding of NaK between the rod and can. The total core mass of about 52 kg of uranium was bathed in a stream of NaK, which served as a coolant.

The final experiment was designed to investigate coefficients of reactivity and, in particular, to study a prompt positive power coefficient without coolant flow. To do this, the system was placed on a period of 60 s at a power of 50 W. About 3 s later the power was 1 MW, the period had decreased to 0.9 s, and core temperatures were rising significantly. The signal to scram the system was given, but by error the slow-moving motor-driven control rods were actuated instead of the fast-acting scram—dropping part of the natural uranium blanket under gravity—as had been done to conclude similar experiments. This change in reactivity caused a momentary drop in power, but was inadequate to overcome the natural processes (very slight bowing inward of the fuel elements) adding reactivity to the system. After a delay of not more than 2 s, the fast scram was actuated, both manually and by instruments, and the experiment completed.

It was not immediately evident that the core had been damaged. Later examination disclosed that nearly one-half the core had melted and vaporized NaK had forced some of the molten alloy into the reflector. Theoretical analysis showed that the excursion was stopped by the falling reflector, after the power reached a maximum of 9 to 10 MW. The total energy release was close to 14 MJ, or about  $4.6 \times 10^{17}$  fissions. The theoretical analysis was carried further in an attempt to determine if the core would have shut itself off in a noncatastrophic manner. The conclusion was that the energy release could have been nearly 2-1/2 times the observed yield but would not have resulted in violent disassembly of the core.

During this incident no one received more than trivial radiation from airborne fission products, and direct exposure was essentially zero.

**II-D.4 Los Alamos Scientific Laboratory, July 3, 1956<sup>21,23</sup>**

*Honeycomb critical assembly; <sup>235</sup>U foils moderated with graphite, control 1/4-mile away.*

The machine in which this excursion occurred is typical of several then in existence. The Los Alamos machine consisted of a large matrix of 576 square aluminum tubes, 3 in. × 3 in. × 6 ft, split down the middle with one-half moveable on tracks. The "Honeycomb" in the disassembled state is shown in Fig. 18. Generally, the facility had been used to simulate design features of complicated reactors because of the versatility in arrangements of uranium foil and various moderating materials. Inhomogeneous stackings in this and similar machines have

the least inherent negative reactivity feedback of any critical assemblies in existence today. This conclusion stems from the apparent lack of any significant quenching mechanism, short of vaporizing the uranium foils, and the absence of a sufficiently fast acting scram mechanism.

The stacking on July 3, 1956, consisted of 58 kg of enriched (93%  $^{235}\text{U}$ ) uranium in the form of 2- and 5-mil foils arranged between slabs of graphite with some beryllium reflector surrounding the core. The total mass of graphite was 1139 kg. At the time, some changes had been made in the reflector and graphite moderator, and criticality was being approached too rapidly for routine measurements. While the cart was moving at about 0.2 in./s, the system became prompt critical, a burst occurred, and the scram system retracted beryllium control rods (reducing reactivity) and reversed the motion of the cart. The burst yield was  $3.2 \times 10^{16}$  fissions.

Apparently this was a Dragon-type excursion in that the excess reactivity was added and subtracted mechanically. There was no damage and no contamination. Because it was remotely controlled from a distance of 1/4 mile, no one received any radiation.

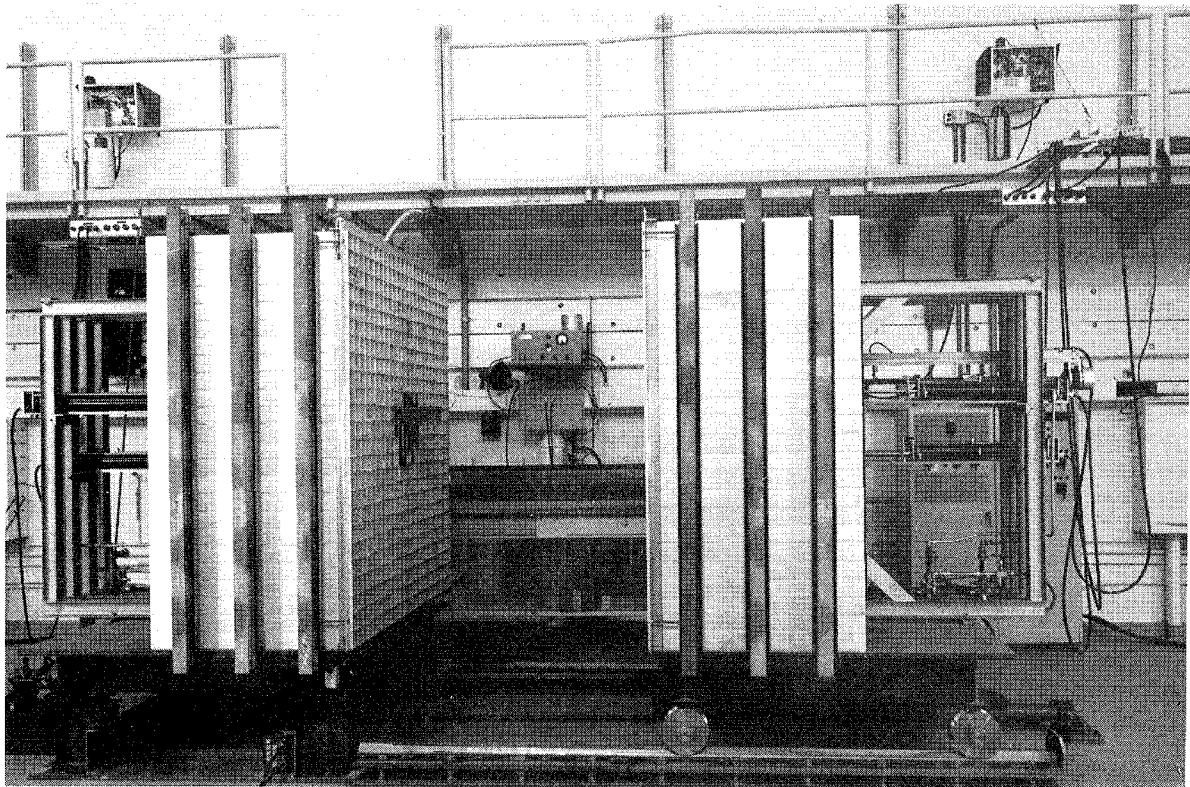

Fig. 18. The LASL Honeycomb assembly machine. The movable section (right) is in the withdrawn position and the aluminum matrix is only partially loaded.



#### II-D.5 The Reactor Testing Area, Idaho Falls, Idaho, Nov. 18, 1958<sup>52</sup>

*Prototype aircraft engine, instrumentation failure.*

The HTRE No. 3 (High-Temperature Reactor Experiment) power plant assembly was a large reactor (core diameter 51 in., length 43.5 in.) with nickel-chromium-UO<sub>2</sub> fuel elements, hydrided zirconium moderator, and beryllium reflector. The experimental objective was to raise the power to about 120 kW, about twice that attained earlier in the day. This was done by manual control until about 10% of desired power was reached. At that point, control shifted to a servo-mechanism programmed to take the reactor power to 120 kW on a 20-s period. When about 80% of full power was attained, the flux, as shown on the power-level recorder, began to fall off rapidly and the servosystem further withdrew the control rods. The power indication, however, did not increase, but continued to drop. This situation existed for about 20 s when the reactor scrammed automatically; within 3 s the operator took action that also activated the scram circuit. It is thought that the automatic scram was triggered by melting thermocouple wires. The primary cause of the accident was a drop in the ion-collecting voltage across the detection chamber of the servosystem with increasing neutron flux. This behavior was, in turn, caused by the addition to the wiring of a filter circuit designed to reduce electronic noise from the high-voltage supply or its connecting cable. Thus this accident seems to be unique. It was due solely to instrumentation.

In the nonviolent power excursion of about  $2.5 \times 10^{19}$  fissions, all core fuel elements experienced some melting; only a few of the zirconium hydride moderator pieces were ruined. The melting of fuel elements allowed a minor redistribution of fuel, decreasing the reactivity by about 2%. Some fission product activity was released downwind, but personnel radiation doses apparently were negligible.

#### II-D.6 Los Alamos Scientific Laboratory, Dec. 11, 1962

*Zepo critical facility, <sup>235</sup>U foils moderated with graphite.*

The critical assembly consisted of a large cylindrical enriched uranium-graphite core on a lift device and a stationary platform holding a reflector of graphite and beryllium into which the core was raised. Most of the <sup>235</sup>U was placed in the graphite in the form of thin foils, therefore the excursion characteristics should be similar to those of the Honeycomb assembly. The experiment was concerned with measurements of the axial fission distribution, which was perturbed from its normal value by an end reflector of layers of graphite and polyethylene. For this reason, some fresh <sup>235</sup>U foils had been placed in the assembly to obtain a reasonably precise value of the fission energy release.

The crew assumed the assembly had been run and checked the previous day; however this was not the case. The system became critical with the core in motion upward. The instrumentation scrammed the assembly when the power was about 200 W. Before the lift could coast to a stop and start down, the system reactivity exceeded prompt criticality by about 12 ¢. Peak power was about 1 MW; maximum alpha was 40/s. The yield was  $3 \times 10^{16}$  fissions. No damage was done and personnel radiation doses were unmeasurable. The laboratory was entered within 30 min.

### III. POWER EXCURSIONS and QUENCHING MECHANISMS

The study and understanding of initiating events and shutdown mechanisms associated with criticality accidents offers the potential of limiting the frequency and consequences of such untoward events. Although more fatalities have been associated with excursions in critical facility and small reactor operations than with processing of fissile material, greater visibility seems to be associated with the safety of processing activities. Perhaps this is because of the larger number of individuals exposed in processing plants, the larger economic impact of facility shutdown, and the recognition of a degree of "assumed risk" for systems operated at or near the critical state.

The most obvious and significant characteristic of the criticality accidents that have occurred in plant operations is that all of them involved solutions. This can be attributed to several factors: the relatively small quantity of fissile material required for criticality when well moderated; the high mobility of solutions; the ease with which they adapt to changes in vessel shape; the potential for changes in concentration; and, in several cases, the exchange of fissile material between aqueous and organic phases. Fortunately, along with the frequency of solution accidents, there is a good understanding of quenching mechanisms and of an inherent limitation to the fission-power density in solutions.

While there must be no implication of neglecting concern with other systems, safety interests may well concentrate on the behavior of solutions. While today's practices strongly encourage reliance on criticality safety features that are built into the process equipment, complete independence from administrative controls is extremely difficult to achieve. Studies of accident mechanisms, both real and simulated, offer insight into features that can mitigate the consequences of the unlikely accident, should it occur. One such feature might involve the inclusion of an appropriately strong neutron source internal to a necessary, nonfavorable-geometry vessel that is to receive solution normally too lean to support criticality and not having a significant inherent neutron source. The CRAC<sup>53</sup> (Consequences Radiologiques d'un Accident de Criticite) experiments clearly demonstrate the efficacy of such a source for limiting the size of first peaks of power transients.

In addition to the understanding gained from studying the process accidents and the reactor and critical assembly excursions involving solution systems, we derive much information from several series of experiments with controlled excursions in solutions. In the United States the KEWB<sup>54,55</sup> (Kinetic Experiments on Water Boilers) series is of interest, while the CRAC experiments performed by the Service d'Etudes de Criticite of the Commissariat a l'Energie Atomique have direct applicability to estimates of accident consequences. These programs, which involved solutions of highly enriched uranium, are supplemented by a series of measurements at Los Alamos using the Sheba assembly, fueled with a nominal 5% enriched uranium solution, that provides information on dose rates near excursions in systems of lower enrichment.<sup>56</sup> Analysis of the data from KEWB and CRAC has led to relatively simple computer codes that follow the early transient

behavior well and that rely on thermal expansion and the formation of microbubbles of radiolytic gas for the shutdown mechanisms.

Transient behavior in moderated solid cores has been studied in the Spert<sup>57,58,59</sup> and TRIGA<sup>60,61</sup> experimental programs, while the very fast transients in simple, unmoderated metal systems are well understood as a result of studies of Godiva and similar fast-burst reactors.

The quenching actions manifest in the above-mentioned experimental studies and which have terminated many of the accidental excursions, include thermal expansion, boiling, <sup>238</sup>U Doppler effect, and bubble formation from fission fragments. The order here is of no importance, and not all are independent. In addition, in some situations, more than one mechanism contributes to quench or shutdown the excursion; in many cases additional quenching actions set in when energy densities or temperatures reach some threshold value. The ramifications of this subject are varied and numerous, but the simplest and most generally applicable case is that of the energy model<sup>62,63,64</sup> in which the change of reactivity is proportional to the release of fission energy.

For the special case of a step increase in reactivity,  $\Delta k_0$ , we can write

$$\Delta k(t) = \Delta k_0 - bE(t) , \quad (1)$$

where  $E(t)$  is the fission energy released to time  $t$  and  $b$  is a constant characteristic of the system. With this assumption, the reactor kinetic equations have been coded for numerical solution by use of digital computers. Such codes exist in many laboratories; the results quoted here are from the Los Alamos RTS Code.<sup>65,66</sup>

Figure 19 illustrates a series of computations for hypothetical systems in which the step increase of  $\Delta k$  is 1.20 \$ relative to delayed criticality, the value of  $b$  is constant, and the neutron lifetime  $l$  is varied from  $10^{-8}$  to  $10^{-4}$  s. The power and reactivity traces for the short neutron lifetime cases are characteristic of prompt excursions in fast reactors. The very sharp rise and fall in power is called the spike, and the relatively constant power following the spike is the plateau. During the spike, the reactivity changes by  $2 \Delta k_0$ —that is, it reflects about prompt criticality. The characteristics of such spikes are established almost entirely by the prompt neutrons. The traces for  $l = 10^{-4}$  (simulating a solution system or a moderated reactor) do not show the reflection about prompt criticality, and there is no well-defined plateau following the spike. The time scale is of the order of the decay times of the shorter delayed neutron precursor; the effects of these neutrons cannot be ignored.

Figure 20 illustrates comparable data for a step increase in reactivity of 1.0 \$. The time history of the reactivity and power in this case is quite different and, indeed, is typical of excursions in the delayed critical region. The time scale is much extended, allowing the possibility of mechanical devices shutting off the transient; power peaks are broader; and the reactivity now attempts to reflect about delayed criticality. It should be noted that the implicit assumption of no heat loss from the system cannot be realized in practice. Any such loss of energy would result in power values greater than those plotted.

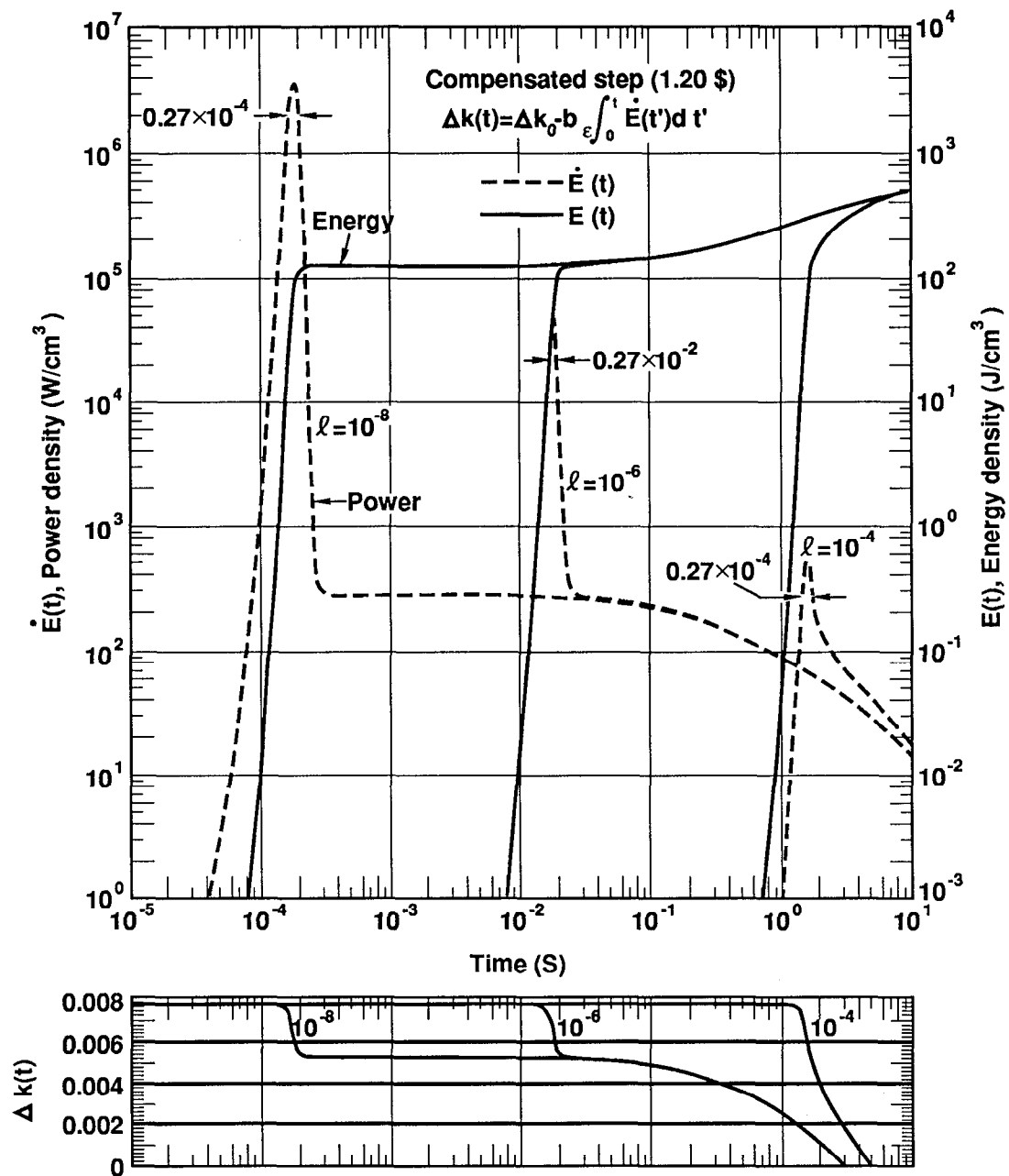

Fig. 19. Energy model computation of power vs time and energy release vs time for an initial reactivity of 1.2 \$ above delayed critical for neutron lifetime values of  $l = 10^{-8}, 10^{-6},$  and  $10^{-4}$  s. Below are the corresponding curves of reactivity vs time.

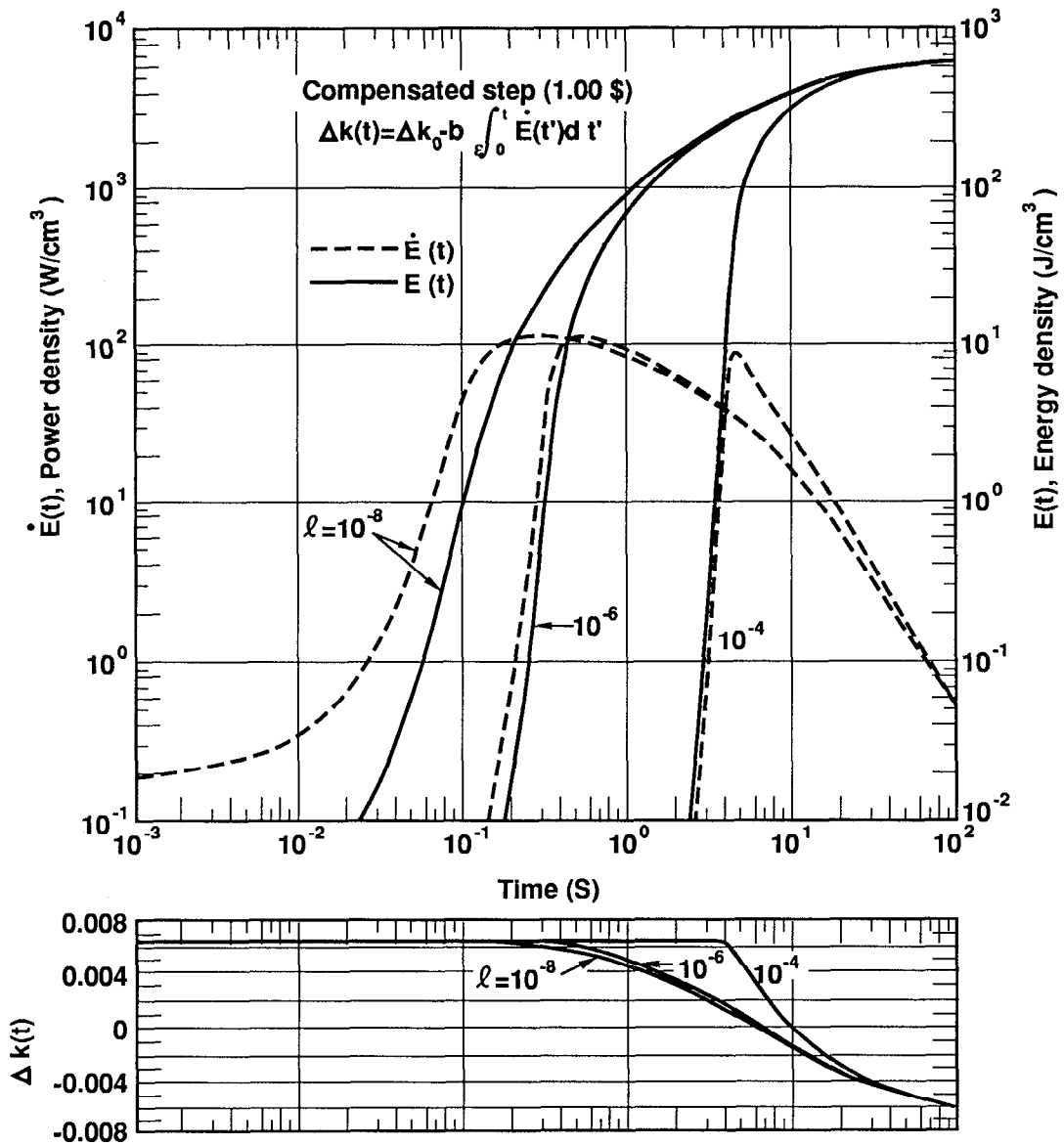

Fig. 20. Energy model computation of power vs time for an initial reactivity of 1.0 \$ above delayed critical for neutron lifetime values of  $l = 10^{-8}$ ,  $10^{-6}$ , and  $10^{-4}$  s. Below are the corresponding curves of reactivity vs time.

Some of the results shown in Figs. 19 and 20 can be obtained analytically. For sufficiently large step increases in reactivity above prompt criticality, the delayed neutrons may be ignored and the kinetic equations integrated to give the total excursion yield.\*

$$dE/dt = 2 \Delta k_p / b \quad (2)$$

where  $\Delta k_p$  is the step increase relative to prompt criticality. The half-width of the spike is given by

$$t_{1/2} = 3.52 l / \Delta k_p , \quad (3)$$

where  $l$  = the neutron lifetime and the maximum power is

$$dE/dt_{max} \sim 2 \Delta k_p^2 / 3.5 bl . \quad (4)$$

The experimental systems that have been intensively studied and that exemplify the data in Figs. 19 and 20 are the Godiva, KEWB, and Spert reactors, and the CRAC experiments.

Godiva I and II were near-solid uranium (93%  $^{235}\text{U}$ ) metal critical assemblies, pressed into service as irradiation facilities. At a few cents above prompt criticality, controlled prompt excursions provide an excellent experimental picture to complement the curves of Figs. 19 and 20. The prompt negative temperature coefficient of reactivity of about  $4.3 \times 10^{-3} \text{ } \$/^\circ\text{C}$  (depending on the model) arises from thermal expansion and is directly related to the deposition of fission energy. The transient proceeds so rapidly that no heat is lost from the system. When the step change of reactivity is increased to 4 or 5  $\epsilon$  above prompt criticality, a new effect sets in. The power rises to such high values that the thermal expansion lags the energy deposition and the simple ratio of  $E$  and  $\Delta k_p$  in Eq. (2) is no longer true. At still higher step changes, the energy release becomes proportional to the square and eventually to the cube of the initial excess reactivity. Structural damage from shocks commences at 10 or 11  $\epsilon$ , thus providing a limit for planned repetitive bursts.

The transient behavior of solution systems has been studied with the two KEWB reactors. The KEWB-A core was a 13.6-L stainless steel sphere containing 11.5 L of highly enriched  $\text{UO}_2\text{SO}_4$  solution; the reflector was thick graphite. This reactor provided a means of studying transients in solution systems during which the period was as short as 2 ms. The KEWB-B core was designed specifically to extend these measurements to a period of 1 ms. It was cylindrical and, during the transient experiments (up to about 5.2  $\$$  above prompt criticality), contained 18 L of  $\text{UO}_2\text{SO}_4$  solution.

In the KEWB systems, two quenching mechanisms seem to be dominant over a wide range of excursions. The first of these is the rise in neutron temperature and thermal expansion as the core temperature rises, resulting in a prompt temperature

---

\*A similar result can be obtained for the delayed critical region, but the nonadiabatic behavior vitiates the result.

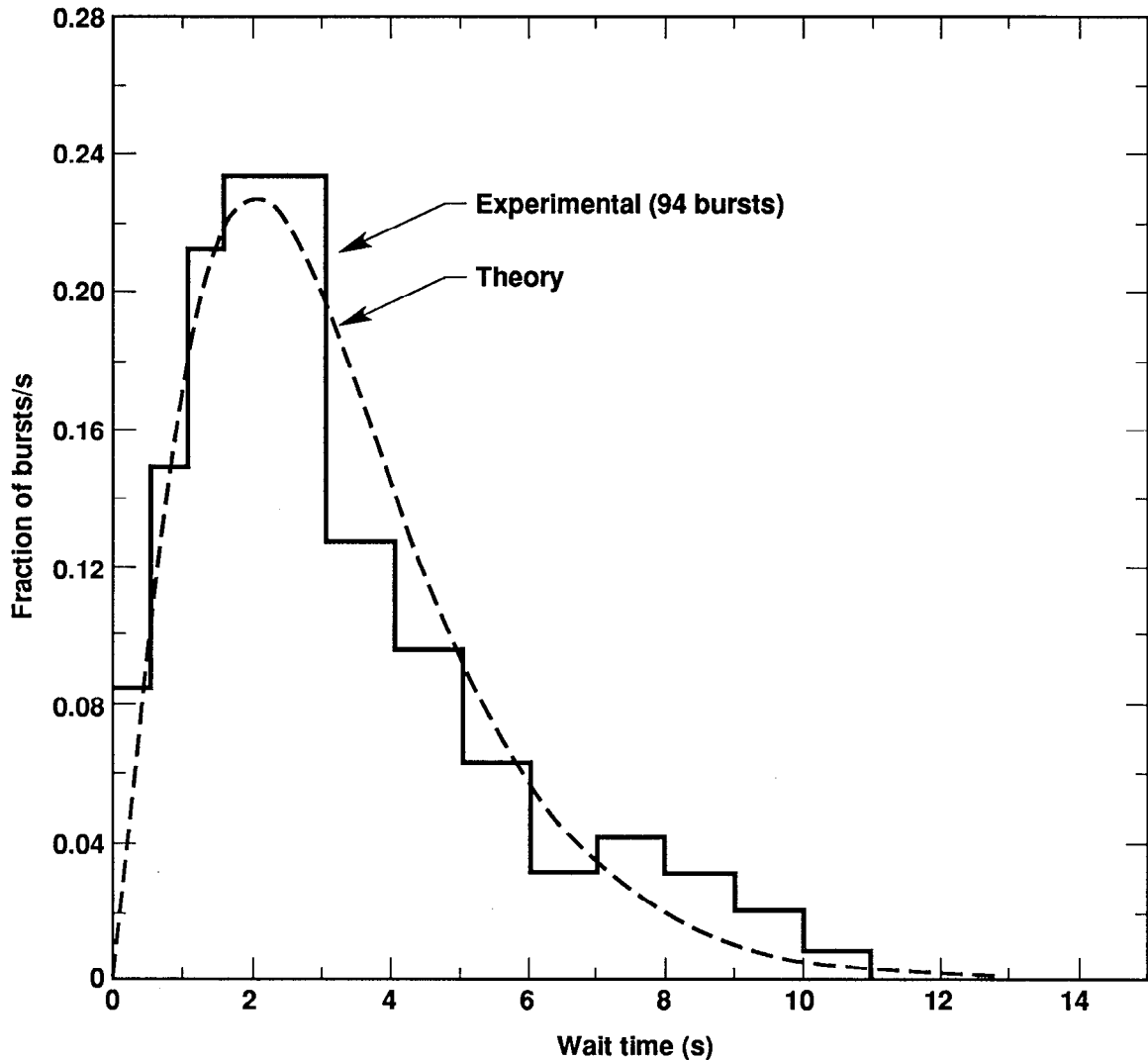

Fig. 21. Distribution in burst wait times after quick (about 50 ms) insertion of 1.05 \$ in Godiva II. Plotted is the fraction of bursts in each second vs wait time in seconds.

coefficient equal to  $-2 \text{ } \epsilon / ^\circ\text{C}$  at  $30^\circ\text{C}$ . This effect is sufficient to account for the observed yield of excursions starting near prompt criticality, but is inadequate for more violent transient experiments. The second quenching mechanism is bubble formation.<sup>67</sup> The available evidence supports the contention that, during the spike, void space consisting of many very small bubbles (microbubbles) with internal pressures of from 10 to 1000 atm is created by the fission process. The bubbles later coalesce and leave the system, giving the observed gas production coefficient of about 4.4 L/MJ.

Growth of these microbubbles seems to involve the repeated interaction between fission fragments and existing microbubbles from earlier fissions. Thus a quenching mechanism proportional to the square of the energy release can be invoked. This model is successful in describing the solution transients,

notwithstanding imprecise knowledge of the manner in which the bubbles form and grow.

While the KEWB, Spert, and TRIGA programs were largely oriented toward reactor safety, the CRAC studies were conceived and conducted to further an understanding of process accidents. Transients were stimulated in cylindrical vessels of 300 and 800 mm diameter with highly enriched uranium solutions having concentrations from 48.2 g/L to 298 g/L. In most experiments, solution was added to a cylinder at a constant rate until the height required for criticality was substantially exceeded. Some experiments used a neutron source of sufficient size to initiate the fission reaction as soon as the system achieved criticality, while the absence of such a source in others permitted the system to become super-prompt critical prior to initiation and resulted in higher spike yields.

The magnitude of the spike yield correlated well with the rate of reactivity addition when a source was present. For periods shorter than 10 ms, the specific peak power was found to vary as the reciprocal period to the 3/2 power, which is in agreement with predictions based on the KEWB results.

The CRAC program also provides helpful guidance regarding dose rates to be expected near unshielded solution excursions. For the 300-mm cylinder the dose at 4 m from the surface of the vessel was about  $2 \times 10^{-15}$  R/fission and for the 800-mm cylinder about  $5 \times 10^{-16}$  R/fission.

Spert-I reactor cores (heterogeneous, moderated and reflected by water)<sup>57</sup> were of two general types. The first had fuel in the form of MTR-type aluminum-uranium plates and cores designed to include the range from undermoderation to the more hazardous region of overmoderation. The second was composed of canned UO<sub>2</sub> rods about 1 cm in diameter. The uranium enrichment in these rods was 4%.

Transients of the plate-type reactors have been extensively studied since 1957 in an effort to solve core design problems and to find the limitations of such reactors. In particular, the period and energy release that can cause damage have been carefully determined. The shutdown of a power transient in the Spert systems is more complicated than in simpler reactors. The model developed includes heating and density change of the water; heating of the core structure, including its own geometry changes and moderator expulsion from such changes; and finally, the boiling of water next to the plates and loss of moderator when water is expelled from the core. When the plate-type core was destroyed, the reactivity, period, peak power, and fission energy release were essentially as predicted. The destructive steam pressure pulse starting some 15 ms after completion of the nuclear phase was not foreseen and is thought to have been caused by very rapid transfer of energy from the near molten aluminum plates to the thin layer of water between the plates. The transfer, occurring before any significant volume change took place, and the resulting high pressure destroyed the core. This effect seems to have been involved in the destruction of BORAX, Spert, and SL-1.

The second type of Spert-I core<sup>57</sup> (4% enriched UO<sub>2</sub> rods in water) was tested during 1963 and 1964. Transient experiments with this core demonstrated the effectiveness of the Doppler mode of self-shutdown and provide a basis for analysis



of accidents in similar power reactor systems. Two attempts to destroy the core by placing the reactor on very short periods (2.2 and 1.55 ms) failed. In each case the Doppler effect was operative and additional quenching developed because one or two fuel pins (out of several hundred) cracked and caused local boiling. The pins were thought to have been water-logged before the test.

## SUMMARY

Although the number of accidental excursions in reactors are too few to permit reliable statistical conclusions, we offer some observations that may be of general interest and some importance. Of the forty-one excursions studied, eight occurred in production plants (and were therefore a complete surprise), five in what must be called working reactors (the water boiler, the second Godiva accident, Dragon, SL-1, and NRX), and the remainder in critical facilities where the properties of the assemblies themselves were being investigated.

The causes and significant features of the process accidents (Table 1) merit a review. The violation of, or the failure to follow, established procedures was an element in at least five of the eight accidents. Off-normal operating conditions (inventory, start-up, or restart after plant maintenance) were present in five. Four of the eight were brief power excursions, four persisted from many minutes to several hours. Four were in facilities where shielding provided protection to personnel, four were unshielded.

In two of the accidents it appears probable that accident alarm systems saved lives. In one case, actions taken after the excursion, without appropriate consideration, resulted in a second power excursion of a size that was potentially lethal; fortunately it did not occur until after personnel had left the immediate area.

All of the process accidents occurred in solutions. Perhaps this can be attributed to the small quantity of material required to achieve criticality when the material is well moderated as well as to the mobility of solutions, their adaptation to the shape of a container, and the ease with which material can transfer between separable phases.

The process accidents were characterized by spike yields of limited size (approximately  $10^{16}$  to  $10^{17}$  fissions). Little or no damage occurred to process equipment. The availability of and the prompt response to criticality accident alarm systems resulted in saving lives of persons more than a few meters from the reaction vessel. Facility down time following an accident appears to have been a function of administrative decisions rather than accident severity.

Six of the eight process accidents occurred in the six years between June 1958 and July 1964. It has been suggested that this represents a time when fissile material processing was being scaled up significantly, but without commensurate attention to nuclear criticality safety. During the more than twenty-five years since, and with dedication to fundamental safety principles, the frequency of accidents has been reduced by approximately an order of magnitude.

Any loss of life is deplorable, but perhaps some comfort can be derived from the fact that the nuclear accident record is significantly better than that of conventional industry. In particular, the record of the material processing activities over the past twenty-five years is commendable, and any significant change in the criticality safety practices that have evolved over the years should be instituted only after the most careful consideration.

Some of the reactor and critical experiments accident data are summarized in Table 2. Where possible and appropriate, the excursion fission energy is divided

into that created in the spike and that in the plateau. Time intervals of interest are also given: the spike width at half maximum, the time from prompt criticality to peak power, and the duration of the plateau. Also given are the maximum alpha (reciprocal period), the peak power during the spike, the initial plateau power, and the probable quenching mechanism. Many of the numbers are, at best, approximate, therefore no estimate of probable error is attempted. As can be seen, the time scales vary from microseconds to seconds. For some excursions, almost all fissions were in the plateau, while others consisted only of a single spike.

Since the two hand-stacking fatalities occurred in the year following the end of World War II, several tens of thousands of approaches to criticality have been performed in critical-mass laboratories and fast-burst reactor facilities without significant injury to personnel or major damage to facilities. The cost of cleaning up contamination and replacing damaged fissionable material has been small compared with the value of the data obtained from these activities.

Personnel exposures from reactor accidents have generally resulted from either deliberate contravention of safety features or violation of procedures. For example, three of the reactor accidents were the result of neglecting to drain moderator from the reactor vessel, as required by procedures, prior to making changes in the core. The accident at Vinca, Yugoslavia (II-C.7) is the exception.

The principal lesson to be learned from this review of criticality accidents is that good procedures, properly followed, are extremely effective in reducing risk.

Table 1. Process Accidents

Event	Date	Location	Material	Geometry	Cause	Physical Damage	Total Fissions	Spike Yield
I-1	6/16/58	Y-12 Plant Oak Ridge, Tenn.	2.5 kg <sup>235</sup> U nitrate	55-gal drum	Wash water added to <sup>235</sup> U solution	None	$1 \times 10^{18}$	$\sim 1 \times 10^{16}$
I-2	12/30/58	Plutonium recovery Los Alamos, N. Mex.	3.27 kg Pu in two-phase system	250-gal cylindrical tank	Stirrer changed geometry to super-critical	None	$1.5 \times 10^{17}$	$1.5 \times 10^{17}$
I-3	10/16/59	Idaho Chemical Processing Plant, Id.	34.5 kg <sup>235</sup> U in $\sim 800$ L water	5000-gal cylindrical tank	Solution inadvertantly siphoned	None	$\sim 4 \times 10^{19}$	$\sim 1 \times 10^{17}$
I-4	1/25/61	Idaho Chemical Processing Plant, Id.	8 kg <sup>235</sup> U in 40 L water	Cylindrical disengagement section	Solution moved to nonsafe geometry	None	$6 \times 10^{17}$	$\sim 6 \times 10^{17}$
I-5	4/7/62	Recuplex Plant, Richland, Wash.	1.55 kg Pu	Cylinder	Vacuum transfer of rich solution to large tank	None	$8 \times 10^{17}$	$\sim 1 \times 10^{16}$
I-6	7/24/64	Wood River Junction, R. I.	2.64 kg <sup>235</sup> U	Cylinder	Solution poured into nonsafe tank	None	$1.3 \times 10^{17}$	$\sim 1 \times 10^{17}$
I-7	8/24/70	BNFL Pu plant Windscale, England	2.15 kg Pu	Cylinder	Pu stripped from aqueous into trapped solvent	None	$\sim 1 \times 10^{15}$	None
I-8	10/17/78	Idaho Chemical Processing Plant, Id.	8.49–10.55 kg U(89); 7.61– 9.31 kg <sup>235</sup> U	Cylindrical scrub column	<sup>235</sup> U stripped from solvent by non- specification aqueous stream	None	$\sim 3 \times 10^{18}$	None

Table 2. Reactor and Critical Experiment Accidents

Event	Date	Location	Material	Geometry	Cause	Damage	Fissions
<b>II-A. Fissile Solution Systems</b>							
II-A.1	12/49	Los Alamos, N. Mex.	~1 kg <sup>235</sup> U as uranyl nitrate	Sphere, graphite reflected	Withdrawal of two control rods	None	$\sim 3 \times 10^{16}$
II-A.2	11/16/51	Richland, Wash.	1.15 kg Pu as nitrate	Bare sphere, 93% filled	Control rods run out too rapidly	None	$8 \times 10^{16}$
II-A.3	5/26/54	Oak Ridge, Tenn.	18.3 kg <sup>235</sup> U as uranyl fluoride	Cylindrical annulus, bare	Tilting of inner cylinder	None	$1 \times 10^{17}$
II-A.4	2/01/56	Oak Ridge, Tenn.	27.7 kg <sup>235</sup> U as uranyl fluoride	Cylinder, bare	Scram plate changed geometry	Slight	$1.6 \times 10^{17}$
II-A.5	1/30/68	Oak Ridge, Tenn.	0.95 kg <sup>233</sup> U as nitrate	Sphere, water reflected	Air bubble added solution to sphere	Local contamination	$1.1 \times 10^{16}$
<b>II-B. Bare and Reflected Metal Systems</b>							
II-B.1	8/21/45	Los Alamos, N. Mex.	6.3 kg delta-phase Pu	Sphere with WC reflector	Hand stacking of reflector	None (one fatality)	$\sim 1 \times 10^{16}$
II-B.2	5/21/46	Los Alamos, N. Mex.	6.3 kg delta-phase Pu	Sphere with Be reflector	Hand stacking of reflector	None (one fatality)	$\sim 3 \times 10^{15}$
II-B.3	3/01/51	Los Alamos, N. Mex.	62.9 kg U(93) metal	Cylinder and annulus in water	Inappropriate scram design	Minor damage to metal parts	$\sim 1 \times 10^{17}$
II-B.4	4/18/52	Los Alamos, N. Mex.	92.4 kg U(93) metal	Cylinder, unreflected	Computation error	None	$1.5 \times 10^{16}$
II-B.5	2/03/54	Los Alamos, N. Mex.	53 kg U(93) metal	Sphere, unreflected	Incorrect operation	Slight damage to pieces	$5.6 \times 10^{16}$

II-B.6	2/12/57	Los Alamos, N. Mex.	54 kg U(93) metal	Sphere, unreflected	Shifting of experiment	Severe damage to assembly	$1.2 \times 10^{17}$
II-B.7	6/17/60	Los Alamos, N. Mex.	~51 kg U(93) metal	Cylinder with 9-in. reflector	Excess material added	Slight	$6 \times 10^{16}$
II-B.8	11/10/61	Oak Ridge, Tenn.	~75 kg U(93) metal	Paraffin reflected	Excess material added	None	$\sim 1 \times 10^{16}$
II-B.9	3/26/63	Livermore, Calif.	47 kg U(93) metal	Cylinder with Be reflector	Held-up part fell into place	Gross damage to assembly	$3.7 \times 10^{17}$
II-B.10	5/28/65	White Sands, N. Mex.	96 kg U(93)-Mo alloy	Cylinder, unreflected	Incorrect operation	Bolts broken, minor damage	$1.5 \times 10^{17}$
II-B.11	9/06/68	Aberdeen, Md.	123 kg U(93)-Mo alloy	Cylinder, unreflected	Incorrect operation	Gross damage to assembly	$6.09 \times 10^{17}$

### II-C. Moderated Metal and Oxide Systems

II-C.1	6/06/45	Los Alamos, N. Mex.	35.4 kg U(79.2) as 1/2-in. cubes	Water reflected pseudosphere	Water leaked into assembly	Minor	$\sim 4 \times 10^{16}$
II-C.2	~1950	Chalk River, Ontario, Canada	Aluminum-clad natural uranium	Rods in heavy water moderator	Excess moderator added, unmonitored	Minor	Unknown
II-C.3	6/02/52	Argonne National Laboratory, IL	U(93) oxide in plastic	Fuel elements in water moderator	Control removed, water not drained	Extensive to fuel elements	$1.22 \times 10^{17}$
II-C.4	12/12/52	Chalk River, Ontario, Canada	Natural uranium fuel rods	Heavy-water moderated reactor	Positive void coefficient	Extensive to core and supports	$1.2 \times 10^{20}$
II-C.5	7/22/54	Idaho Reactor Testing Area, Id.	4.16 kg U(93) as U/Al alloy	Fuel elements in water moderator	Planned transient exceeded	Extensive	$4.68 \times 10^{18}$
II-C.6	10/15/58	Vinca, Yugoslavia	natural uranium rods	Fuel rods in heavy water	Faulty power monitoring	None reported (one fatality)	$\sim 2.6 \times 10^{18}$

Table 2. Reactor and Critical Experiment Accidents (Contd.)

Event	Date	Location	Material	Geometry	Cause	Damage	Fissions
II-C.7	3/15/60	Saclay, France	2.2 tons U(1.5) as oxide	Fuel rods in water	Removal of poison rod	None	$3 \times 10^{18}$
II-C.8	1/03/61	Idaho Reactor Testing Area, Id.	U(93) clad in aluminum	Fuel rods in water	Removal of control rod	Extensive (three fatalities)	$4.4 \times 10^{18}$
II-C.9	11/05/62	Idaho Reactor Testing Area, Id.	U(93)/Al alloy plates, Al clad	Fuel elements in water	Planned transient exceeded	Extensive	$\sim 1 \times 10^{18}$
II-C.10	12/30/65	Mol, Belgium	U(7) oxide	Rods in water/heavy water	Misoperation plus not draining tank	None (one severe exposure)	$\sim 4 \times 10^{17}$
II-C.11	9/23/83	Buenos Aires, Argentina	MTR type fuel elements	Pool type reactor	Failure to drain tank	None (one fatality)	$\sim 4 \times 10^{17}$
<b>II-D. Miscellaneous Systems</b>							
II-D.1	2/11/45	Los Alamos N. Mex.	Uranium hydride in styrex	The Dragon assembly	Yields increased to achieve damage	Blistering of plastic	$\sim 6 \times 10^{15}$
II-D.2	~1954	U.S.S.R.	Unknown	Unknown	Unknown	Unknown	$\sim 1 \times 10^{16}(?)$
II-D.3	11/29/55	Argonne National Laboratory, Id.	Enriched uranium in NaK	EBR-1	Delayed scram during transient	Extensive core melting	$\sim 4 \times 10^{17}$
II-D.4	7/03/56	Los Alamos N. Mex.	U(93) foils in graphite	Honeycomb	Rapid addition of reactivity	None	$3.2 \times 10^{16}$
II-D.5	11/18/58	Reactor Testing Area, Id.	Uranium oxide in nickel-chromium	Aircraft engine prototype	Instrumentation malfunction	Some fuel melting	$2.5 \times 10^{19}$
II-D.6	12/11/62	Los Alamos, N. Mex.	Large U(93) graphite cylinder	Cylinder plus annular reflector	Faulty start-up operations	None	$\sim 3 \times 10^{16}$

## REFERENCES

1. Stratton, W. R., *Review of Criticality Accidents*, Los Alamos Scientific Laboratory, Los Alamos, N. Mex., LA-3611 (1967).
2. *Accidental Radiation Excursion at the Y-12 Plant June 16, 1958*, Union Carbide Nuclear Company, Y-12 Plant, Oak Ridge, Tenn., Y-1234, (1958).
3. Callihan, D., and J. T. Thomas, "Accidental Radiation Excursion at the Oak Ridge Y-12 Plant—1, Description and Physics of the Accident," *Health Phys.*, **1**, 363—372, (1959).
4. "Oak Ridge Y-12 Accidental Excursion, June 16, 1958," *Nucleonics*, **16**, Nov., 138—140, 200—203 (1958).
5. Paxton, H. C., R. D. Baker, W. J. Maraman, and R. Reider, *Nuclear-Critical Accident at the Los Alamos Scientific Laboratory on December 30, 1958*, Los Alamos Scientific Laboratory, Los Alamos, N. Mex., LAMS-2293 (1959).
6. Paxton, H. C., R. D. Baker, W. J. Maraman, and R. Reider, "Los Alamos Criticality Accident, December 30, 1958," *Nucleonics*, **17** (4) 107—108, 151 (1959).
7. Ginkel, W. L., C. W. Bills, A. O. Dodd, K. K. Kennedy, and F. H. Tingey, *Nuclear Incident at the Idaho Chemical Processing Plant on October 16, 1959*, Phillips Petroleum Co., Atomic Energy Div., Idaho Falls, Idaho, IDO-10035, (1960).
8. Paulus, P. C., A. O. Dodd, K. K. Kennedy, F. H. Tingey, and F. M. Warzel, *Nuclear Incident at the Idaho Chemical Processing Plant on January 25, 1961*, Phillips Petroleum Company, Atomic Energy Div., Idaho Falls, Idaho, IDO-10036 (1961).
9. Callihan, D., "Accidental Nuclear Excursion in Recuplex Operation at Hanford in April 1962," *Nucl. Safety*, **4**, (4) 136 (1963).
10. Clayton, E. D., *Further Considerations of Criticality in Recuplex and Possible Shutdown Mechanism*, Hanford Atomic Products Operation, Hanford, Wash., HW-77780 (1963).
11. Zangar, C. N., *Summary Report of Accidental Nuclear Excursion Recuplex Operation 234-5 Facility*, HW74723, Richland Operations Office, AEC, TID—18431 (1962).
12. Nakache, F. R., and M. M. Shapiro, *The Nuclear Aspects of the Accidental Criticality at Wood River Junction, Rhode Island, July 24, 1964*, Supplemental Report, United Nuclear Corp., New Haven, Conn., Fuels Div., TID-21995 (1964).
13. Kouts, H., et al., Report of the AEC Technical Review Committee, Nov. 6, 1964.
14. Daniels, J. T., H. Howells, and T. G. Hughes, "Criticality Incident-Aug 24, 1970, Windscale Works," *Trans. Am. Nuc. Soc.*, **14**, 35—36 (1971).
15. Evans, M. C., "A Review of Accidents Within the European Community," *Trans. Am. Nuc. Soc.*, **46**, 462—463 (1984).
16. Hayes, D. F., *A Summary of Accidents and Incidents Involving Radiation in Atomic Energy Activities, June 1945 through December 1955*, U. S. Atomic Energy Commission, TID-5360 (1956).
17. King, L. D. P., "Design and Description of Water Boiler Reactors," *Proc. Intern. Conf. Peaceful Uses At. Energy, Geneva, 1955*, vol. 2, pp. 372—391 (1955).
18. Leonard, Jr., B. R., *A Study of the Radiation Burst in the Hanford Homogeneous Reactor*, Hanford Works, Richland, Wash., HW-24327, (1952).
19. Thomas, J. T., and A. D. Callihan, *Radiation Excursions at the ORNL Critical Experiments Laboratory. I. May 26, 1954. II. February 1, 1956*, Oak Ridge National Laboratory, Oak Ridge, Tenn., ORNL-2452, (1958).
20. Callihan, D., *Excursion at the Oak Ridge Critical Experiments Facility, January 30, 1968*, Oak Ridge National Laboratory, Oak Ridge, Tenn., ORNL-TM-2207, (1968).
21. Paxton, H. C., "Critical-Assembly Booby Traps," *Nucleonics* **16**, Mar., 80—81 (1958).
22. Paine, Jr., R. W., R. Sl Dike, J. D. Orndoff, and D. P. Wood, *A Study of an Accidental Radiation Burst*, Los Alamos Scientific Laboratory, Los Alamos, N. Mex., LA-1289 (1951).
23. Paxton, H. C., *Booby Traps*, Los Alamos Scientific Laboratory, Los Alamos, N. Mex., AECD-4240, (1957).



24. Mallery, E. C., G. E. Hansen, G. A. Linenberger, and D. P. Wood, *Neutron Burst from a Cylindrical Untamped Oy (Enriched U) Assembly*, Los Alamos Scientific Laboratory, Los Alamos, N. Mex., LA-1477, (1952).
25. Peterson, R. E., and G. A. Newby, "An Unreflected U-235 Critical Assembly," *Nucl. Sci. Eng.* **1**, 112—125 (1956).
26. Wimett, T. F., L. B. Engle, G. A. Graaves, G. R. Keepi, Jr., and J. D. Orndoff, *Time Behavior of Godiva Through Prompt Critical*, Los Alamos Scientific Laboratory, Los Alamos, N. Mex., LA-2029 (1956).
27. Paxton, H. C., "Godiva, Topsy, Jezebel—Critical Assemblies at Los Alamos," *Nucleonics* **13**, Oct., 48—50 (1955).
28. Paxton, H. C., "Godiva Wrecked at Los Alamos," *Nucleonics* **15**, Apr., 104 (1957).
29. Stratton, W. R., T. H. Colvin, and R. B. Lazarus, "Analyses of Prompt Excursions in Simple Systems and Idealized Fast Reactors," in *Proc. UN Intern. Conf. Peaceful Uses At. Energy, 2nd, Geneva, 1958*, (United Nations, Geneva, 1958) vol. 12, pp. 196—206.
30. Wimett, T. F., and J. D. Orndoff, "Applications of Godiva II Neutron Pulses," in *Proc. UN Intern. Conf. Peaceful Uses At. Energy, 2nd, Geneva, 1958*, (United Nations, Geneva, 1958) vol. 10, pp. 449—460.
31. Callihan, D., *Criticality Excursion of November 10, 1961*, Oak Ridge National Laboratory, Oak Ridge, Tenn., ORNL-TM-139, (1962).
32. Kathren, R. L., W. C. Day, D. H. Denham, and J. L. Brown, *Health Physics Following a Nuclear Excursion: The LRL Incident of March 26, 1963*, Lawrence Livermore National Laboratory, Livermore, Calif., UCRL-7345, (1963).
33. *Fast Burst Reactor Facility Operations report Number 2*, White Sands Missile Range, White Sands, N. Mex., (1965).
34. Kazi, A. H., H. G. Dubyoski, and E. W. Dickinson, "Preoperational Test Experience with the Army Pulse Radiation Facility Reactor," in *Proceedings of the National Topical Meeting on Fast Burst Reactors, Albuquerque, N. Mex.*, (U. S. Atomic Energy Commission, 1969), pp. 353—371.
35. Brittan, R. O., R. J. Hasterlik, L. D. Marinelli, and F. W. Thalgott, *Technical Review of ZPR-1 Accidental Transient—The Power Excursion, Exposures, and Clinical Data*, Argonne National Laboratory, Argonne, Ill., ANL-4971, (1953).
36. Lewis, W. B., *The Accident to the NRX Reactor on December 12, 1952*, Atomic Energy of Canada, Ltd., Chalk River Project, Chalk River, Ont., DR-32 (1953).
37. Hurst, D. G., and A. G. Ward, "Canadian Research Reactors," in *Progress in Nuclear Energy, Series II, Reactors*, vol. I, R. A. Charpie, D. J. Hughes, D. J. Littler, and M. Trocheris, Eds. (Pergamon Press, London, 1956) pp. 1—48.
38. Dietrich, J. R., *Experimental Investigation of the Self-Limitation of Power During Reactivity Transients in a Subcooled, Water-Moderated Reactor*, Argonne National Laboratory, Argonne, Ill., AECD-5323 (1954).
39. "Reactors," *Nucleonics*, **13**, Sept., 40—45 (1955).
40. Dietrich, J. R., "Experimental Determinations of the Self-Regulation and Safety of Operating Water-Moderated Reactors," in *Proc. Intern. Conf. Peaceful Uses At. Energy, Geneva, 1955*, (United Nations, New York, 1956) vol. 13, pp. 88—101.
41. J. R. Dietrich and D. C. Layman, *Transient and Steady State Characteristics of a Boiling Reactor. The Borax Experiments, 1953*, Argonne National Laboratory, Argonne, Ill., AECD-3840 (1954).
42. Thompson, T. J., and J. G. Beckerley, Eds. *The Technology of Nuclear Reactor Safety*, vol. 1, (The M.I.T. Press, Cambridge, Mass 1964).
43. Lushbaugh, C. C., "Reflections on Some Recent Progress in Human Radiobiology," in *Advances in Radiation Biology*, vol. 3, L. G. Augenstein, R. Mason, and M. Zelle, Eds. (Academic Press Inc., 1969), pp. 277—314.
44. Tardiff, A. N., "Some Aspects of the WTR and SL-1 Accidents," in *Proc. Symp. Reactor Safety and Hazards Evaluation Techniques*, vol. 1 (International Atomic Energy Agency, Vienna, 1962) pp. 43—88.

45. Nyer, W. E., G. O. Bright, and R. J. McWhorter, "Reactor Excursion Behavior," in *Proc. UN Intern. Conf. Peaceful Uses At. Energy, 3rd, Geneva, 1964*, vol. 13 (United Nations, Geneva, 1965), pp. 13—25.
46. US NRC Information Notice No. 83-66, Supplement 1: Fatality at Argentine Critical Facility, May 25, 1984.
47. Frisch, O. R., *Controlled Production of an Explosive Nuclear Chain Reaction*, Los Alamos Scientific Laboratory, Los Alamos, N. Mex., LA-397 (1945).
48. de Hoffman, F., B. T. Feld, and P. R. Stein, "Delayed Neutrons from U<sup>235</sup> After Short Irradiation," *Phys. Rev.*, **74**, (10) 1330—1337 (1948).
49. Guskova, A. K., and G. D. Baisogolov, "Two Cases of Acute Radiation Disease in Man," in *Proc. Intern. Conf. Peaceful Uses At. Energy, Geneva, 1955*, vol.11 (United Nations, New York, 1955), p. 35—44.
50. Brittan, R. O., "Analysis of the EBR-1 Core Meltdown," in *Proc. UN Intern. Conf. Peaceful Uses At. Energy, 2nd Geneva, 1958*, vol. 12 (United Nations, Geneva, 1958), pp. 267—272.
51. Kittel, J. H., M. Novick, and R. F. Buchanan, *The EBR-1 Meltdown—Physical and Metallurgical Changes in the Core*, Argonne National Laboratory, Argonne, Ill., ANL-5731, (1957).
52. *Summary Report of HTRE No. 3 Nuclear Excursion*, General Electric Co., Aircraft Nuclear Propulsion Dept., Cincinnati, Ohio, APEX-509 (1959).
53. Lecorche, P., and R. L. Seale, *Review of the Experiments Performed to Determine the Radiological Consequences of a Criticality Accident, Y-12 Plant, Oak Ridge, Tenn., Y-CDC-12* (1973).
54. Remley, M. E., J. W. Flora, D. L. Hetrick, D. R. Muller, E. L. Gardner, R. E. Wimmer, R. K. Stitt, and D. P. Gamble, "Experimental Studies on the Kinetic Behavior of Water Boiler Type Reactors," in *Proc. UN Intern. Conf. Peaceful Uses At. Energy, 2nd, Geneva 1958*, vol.11 (United Nations, Geneva, 1958), pp. 447—456.
55. Stitt, R. K., "A Summary of Experimental Results of the Spherical Core Investigations in the Kewb Program," *Nucl. Sci. Eng.*, **2** (1), Suppl., 212—213 (1959).
56. Malenfant, R. E., H. M. Forehand, J. J. Koeling, "Sheba: A Solution Critical Assembly," *Trans. Amer. Nucl. Soc.* **35** p. 279 (1980).
57. Forbes, S. G., F. L. Bentzen, P. French, J. E. Grund, J. C. Haire, W. E. Nyer, and R. F. Walker, *Analysis of Self-Shutdown Behavior in the Spert-I Reactor*, Phillips Petroleum Company, Atomic Energy Div., Idaho Falls, Idaho, IDO-16528 (1959).
58. Nyer, W. E., and S. G. Forbes, "SPERT-I Reactor Safety Studies," in *Proc. UN Intern. Conf. Peaceful Uses At. Energy, 2nd, Geneva, 1958*, vol. 11 (United Nations, Geneva, 1958), pp. 470—480.
59. Schroeder, F., S. G. Forbes, W. E. Nyer, F. L. Bentzen, and G. O. Bright, "Experimental Study of Transient Behavior in a Subcooled, Water-Moderated Reactor," *Nucl. Sci. Eng.* **2**, 96—115 (1957).
60. Stone, R. S., H. P. Sleeper Jr., R. H. Stahl, and G. West, "Transient Behavior of TRIGA, a Zirconium-Hydride, Water-Moderated Reactor," *Nucl. Sci. Eng.*, **6**, 255—259 (1959).
61. Koutz, S. L., T. Taylor, A. McReynolds, F. Dyson, R. S. Stolne, H. P. Sleeper Jr., and R. B. Duffield, "Design of a 10-kw Reactor for Isotope Production, Research and Training Purposes," in *Proc. UN Intern. Conf. Peaceful Uses At. Energy, 2nd, Geneva, 1958*, vol.10 (United Nations, Geneva, 1958), pp. 282—286.
62. Hansen, G. E., *Burst Characteristics Associated with the Slow Assembly of Fissionable Materials*, Los Alamos Scientific Laboratory, Los Alamos, N. Mex., LA-1441 (1952).
63. Fuchs, K., *Efficiency for Very Slow Assembly*, Los Alamos Scientific Laboratory, Los Alamos, N. Mex., LA-596 (1946).
64. Hansen, G. E., "Assembly of Fissionable Material in the Presence of a Weak Neutron Source," *Nucl. Sci. Eng.*, **8**, 709—719 (1960).
65. Keepin, G. R., *Physics of Nuclear Kinetics*, (Addison Wesley Pub. Co., Reading, Mass., 1965), p. 435.
66. Keepin, G. R., "General Solution of the Reactor Kinetics Equations," *Nucl. Sci. Eng.*, **8**, 670—690 (1960).

67. Gamble, D. P., "A Proposed Model of Bubble Growth During Fast Transients in the Kewb Reactor," *Nucl. Sci. Eng.*, 2, (1), Suppl., 213—214 (1959).

## APPENDIX

### Chernobyl Nuclear Power Station, The Ukraine, Soviet Union

Wm. R. Stratton

The Chernobyl nuclear power station consisted of four RBMK-1000 (1000 MW electric) graphite-moderated and water-cooled reactors. Unit 4 was the newest of the four and had first been put into operation at the end of 1983. The graphite core of these reactors is very large, having a diameter of about 12 m and a height of 7 m. The core has 1700 vertical coolant channels that contain zircalloy-clad UO<sub>2</sub> pellets of about 2% enriched uranium. The system operates as a boiling water reactor with two coolant loops. Because of the relatively large spacing of the coolant tubes, the neutron spectrum is very soft and the water can act as a poison. Especially for conditions during which little steam is present, the void coefficient is positive. This was the situation April 26, 1986.

The operators were conducting an experiment to determine how long the turbine generator could provide useful power following initiation of a scram action. The reactor was at low power and the coolant channels were filled with high-temperature pressurized water when the operators simultaneously reduced the feedwater flow by a factor of two and scrammed the reactor. Reduction of flow allowed the water to boil, thus increasing reactivity and power, which caused more water to boil before the relatively slow action of the control rods could reduce the power. The process was autocatalytic and very rapid, increasing the reactor thermal power by a very large factor (at least several hundred). The transient was terminated by a steam explosion that destroyed the core and part of the reactor building, releasing fission products into the environment. Some UO<sub>2</sub> fuel was pulverized and ejected from coolant tubes, another indication of the extreme temperatures created in the fuel.

#### References

1. "The Accident at the Chernobyl Atomic Energy Station and Its Consequences," *State Committee for Using the Atomic Energy of USSR, 25-29 August 1986*, Vienna Austria. Translated by the U. S. Department of Energy, Washington D. C. (1986)
2. *Report of the U. S. Department of Energy's Team Analysis of the Chernobyl-4 Atomic energy Station Accident Sequence*. U. S. Department of Energy (1986).
3. *Intermediate Report of the Reactor Safety Commission about a Preliminary Evaluation of the Accident at the Chernobyl Nuclear Power Plant as it affects Nuclear Power Plants in the Federal Republic of Germany*, Business Office of the Reactor Safety Commission, 6 June 1986. Translated by the U. S. NMRC, ACRS (1986).
4. Report of the International Safety Advisory Group (INSAG) on the Chernobyl Accident, September 9, 1986, Vienna, Austria.

The nuclear power station at Chernobyl is discussed in *Soviet Life*, February 1986, No. 2 (353), pages 6-15. Photographs of the plant, the main hall above the reactor, the control room, etc. are shown.

# NUCLEAR CRITICALITY TECHNOLOGY

# NUCLEAR CRITICALITY TECHNOLOGY

University of California

